

CHAPTER IV
APPLICATION OF RISK ASSESSMENT INTEGRATED
WITHIN RANDOM-FUZZY NETWORK (RAIRFNET) TO
A BORED PILE CONSTRUCTION PROJECT

The purposes of this section are two folds: 1) to demonstrate the calculations performed using the concept of random-fuzzy variables incorporated in the risk assessment and to interpret the obtained results (i.e., degree of risk), and 2) to integrate the risk assessment results into the schedule network. The subsequent subsection describes, first, the characteristics of the example projects employed to demonstrate the applications. Then, available data obtained from the example projects are presented. Assumptions and adjustments of the RAIRFNET are provided based on the available data. Next, detailed outputs obtained from the applications of the RAIRFNET are discussed. Comparisons among methods used to compute the project completion time are performed. The considered methods includes Monte Carlo simulation, the RAIRFNET using the Salicone's method processed on data associated with activity duration, the RAIRFNET using the neurofuzzy metamodel trained on data associated with activity duration, the Salicone's method processed on data associated with project completion times, and the neurofuzzy metamodel trained on data associated with project completion times.

4.1 Example Project

To demonstrate the application of RAIRFNET, an example project is a bored pile construction project being constructed in Bangkok. There are 6 main activities (i.e., drilling, desanding, cage installation, tremie installation, concrete pouring, and soil removal) which are composed of 31 sub-activities presented through the network shown in Figure 4.1. The sequence of bored piling process is investigated and summarized in order to develop a simulation model to capture such process. The probabilistic scheduling network of the bored pile construction process which is shown in Figure 4.2 as a simplified network for demonstrating the application of the proposed method in a simply manner, is analyzed by using the STROBOSCOPE simulation system (Martinez, 1996).

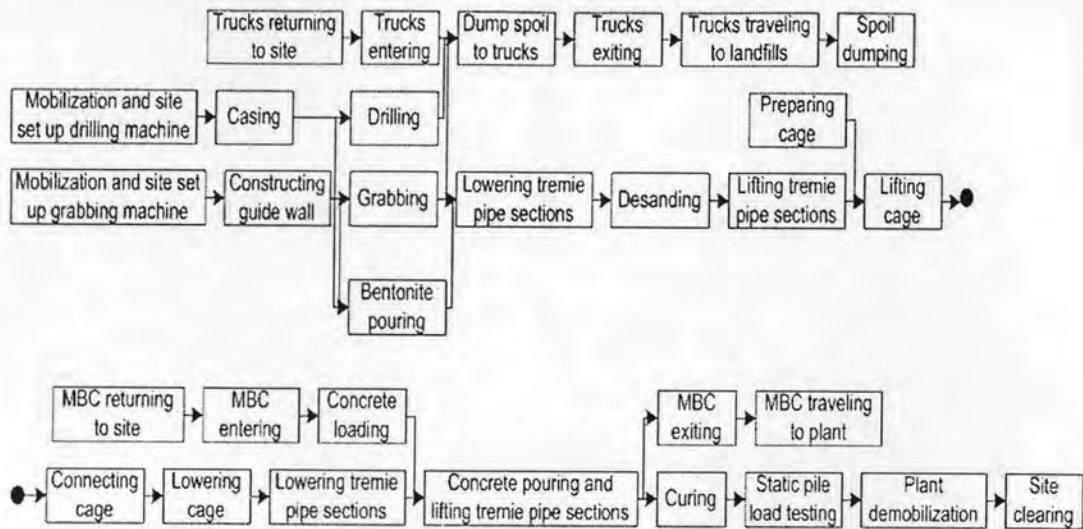

Figure 4.1 A scheduling network of bored pile construction

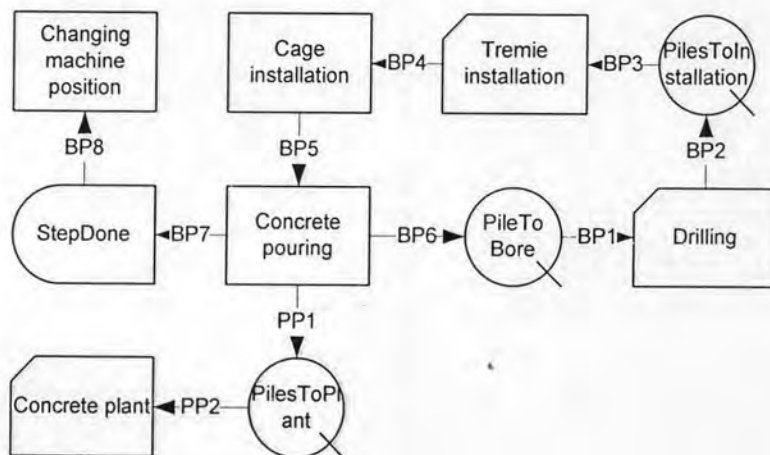

Figure 4.2 A scheduling network of bored piling process

In regard to the capabilities in modeling a random contribution to uncertainty associated with the bored pile construction process, the Monte Carlo method is used to sample the random variables in the simulation model. The sampled values are then used as inputs for the time equations. The time equations which are functions of risk variables are used to measure the values of impact of risk factors on the activity duration. The inputs (i.e., activity duration accounting for impact of risk factors) for CPM calculations to determine the duration of the scheduling network are calculated from these equations. After a large number of replications, the collection of the simulated durations and the corresponding risk variables is built. Then, parameters (i.e., mean, standard deviation) of probability distribution functions of activity duration are computed. The results are later used to develop the membership functions representing the random part of random-fuzzy variables (i.e., activity duration).

Two probability–possibility transformation methods are worked out to illustrate their capabilities and performance. The method proposed by Salicone (2007) is used to transform the probability distribution functions into the membership functions by using the means and standard deviations. To take an advantage of simulation data associated with activity duration and risk variables, the neurofuzzy metamodeling concept is introduced in this research. The membership functions developed by using the neurofuzzy metamodel depend on training data or simulation data.

To enable the comparison between these two methods, the membership functions of each random–fuzzy variable are developed from the same dataset. The durations of activities and risk variables expressed in the form of quadruples are compared in association with each α – cut level (i.e., 0, 0.25, 0.50, 0.75, and 1.00). The comparisons between project completion times obtained from the simulation model, and the RIARFNET applying the Salicone’s method to provide durations of project activities and the RAIRFNET using the neurofuzzy metamodel to provide durations of project activities are performed. As the proposed method calculates the random fuzzy early start and finish times for all activities at different α – cut levels, the comparing results are presented in association with each α – cut level.

To take an advantage of simulation data associated with project completion times, the membership functions of the project completion times are developed by using the Salicone’s method processed on project completion time data and the neurofuzzy metamodel trained on project completion time data. The project completion times obtained from these two methods for any given values of risk variables are determined at each α – cut level. The results are compared with the project completion times provided by other methods (i.e., simulation model, RIARFNET applying the Salicone’s method to develop the membership function of activity duration and RAIRFNET using the neurofuzzy metamodel to develop the membership function of activity duration).

The proposed method develops the membership functions representing confidence intervals of the systematic and unknown contributions which present a nonrandom part of a random–fuzzy variable by using the rectangular and trapezoidal membership functions. Then, the integration between the membership functions presenting the random part obtained by using the probability–possibility

transformation methods and the nonrandom part obtained by using the expert's judgement is performed. To compare the proposed methods with the probabilistic methods (i.e., simulation), the integrated membership functions and the corresponding probability distributions of activity duration and project completion time are compared.

The second example project presented in the next chapter is adopted from the literature (Sarutirattanaworakun, 2005). It is also an actual drainage water tunneling project being constructed in Bangkok. The tunnel construction is used to present the application of the RAIRFNET as it is one of the most complex and risky types of construction projects. It does not only involve a large number of interrelated operations, but it is also affected by several uncontrollable factors. The uncontrollable factors accordingly make the durations of activities and the project completion time for the future become very uncertain.

Based on the available information, the main tunneling operation of this project is composed of three main processes: 1) tunnel excavation by an EPB machine, 2) tunnel lining installation, and 3) muck and lining transportation. The sequence of each process was summarized and represented by the flow charts. The precedence logic of tunneling processes was developed by integrating the sequence of the tunneling processes with technical and resource constraints. The network and its detailed description were presented by using a time – scaled arrow network. Simulation models were developed based on different construction scenarios to yield realistic results. Uncertainty associated with tunneling processes was assimilated through random process duration. The parameters of the time equations were assessed by using the PERT method. The optimistic, most likely, and pessimistic speeds of the train in this project were estimated.

To apply the RAIRFNET, the activity duration and risk variables are considered as random–fuzzy variables. The means and variances of representing the random part of these random–fuzzy variables are obtained by executing simulation models. The corresponding membership functions of the random–fuzzy variables are developed by using the probability–possibility transformation method (Silicone, 2007) and alternatively the neurofuzzy metamodel. As particular input data required by the RAIRFNET cannot be obtained from Sarutirattanaworakun (2005), some assumptions are made together with the use of the identified risk factors and available

information associated with their attributes obtained from the literature (Pongmee, 2006).

4.2 Demonstration of RAIRFNET Calculations for a Bored Piling Project

The main objective of this subsection is to discuss, in detail, the step – by – step calculations performed using the RAIRFNET which includes risk weight calculation using FAHP, risk assessment, development of probability distribution functions and membership functions of the temporal variable and risk variables, and RAIRFNET calculation. The required data include relative significance of risk factors, quantitative and subjective likelihood and consequence of risk factors, initially estimated activity duration, and assigned values of epistemic uncertainty.

4.2.1 Risk Weight Calculation

The proposed method using FAHP to provide weight or degree of significance of a risk factor is described in this section. The main purposes of this section are to illustrate the calculation performed using the FAHP and interpret the generated degrees of significance of risk factors. The subsequent section describes, first, the establishment of scale of comparison structure and risk assessment. Then, detailed outputs provided by FAHP and the step – by – step demonstration of the calculations performed using a selected example are discussed.

1) Establishment of Scale of Comparison Structure and Risk Assessment

In a demonstrative application of the FAHP, the evaluation of the weight of each of the risk factors is made by using triangular fuzzy conversion scale given in Table 4.1 (data from Büyüközkan, 2007). Table 4.1 also presents the decision aids for the risk assessment proposed by Georgy (2005) which are employed to assign the linguistic risk evaluating scale.

2) Demonstrative Application of FAHP

This subsection presents an example designed in a demonstrative application of the FAHP. The application illustrates the assessment of risk factors having impact on bored pile construction projects. The evaluations were provided based on the information supplied by the experts who have in-depth knowledge about problems

and a good understanding of risk factors and adverse consequence. The risk factors were classified into operation risk and management risk in order to highlight risk factors having significant impacts on the activity level and project level. The integration of risk identification and classification into the designed construction process was to depict critical activities having significant impacts on the accomplishment of a project.

Table 4.1 Triangular fuzzy conversion scale (data from Büyüközkan, 2007)

Numerical rating	Relative significance		Risk assessment	
	Linguistic term	Triangular fuzzy scale	Linguistic term	Triangular fuzzy scale
1	Equally significant	(0.5,1,1.5)	Very low	(0.2, 0.4,0.5)
3	Weakly more significant	(1,1.5,2)	Low	(0.4,0.5,0.6)
5	Strongly more significant	(1.5,2,2.5)	Medium	(0.5,0.7,0.8)
7	Very strongly more significant	(2,2.5,3)	High	(0.6,0.8,0.9)
9	Absolutely more significant	(2.5,3,3.5)	Very high	(0.8,0.9,1.0)

To determine weights w_k of the risk factors or to identify the comparison structure among risk factors, the experts were asked to provide judgement of the relative significance of these risk factors. The determination of the weights of five risk factors affecting the drilling activity is provided as an example. The significant risk factors having impact on the drilling activity are composed of (1) Late delivery of main equipment for a specific data, (2) high water pressure, (3) broken down equipment, (4) heavy rain, and (5) geographic uncertainty. A tentative assessment of the relative significance is performed regarding the following statements

- (1) Late delivery of main equipment for a specific data is far more significant than high water pressure
- (2) Late delivery of main equipment for a specific data is far more significant than broken down equipment
- (3) Late delivery of main equipment for a specific data is as significant as heavy rain
- (4) Late delivery of main equipment for a specific data is as significant as geographic uncertainty
- (5) Heavy rain is particularly significant comparing to high water pressure
- (6) Heavy rain is particularly significant comparing to broken down equipment
- (7) Geographic uncertainty is particularly significant comparing to high water pressure
- (8) Geographic uncertainty is particularly significant comparing to broken down equipment.

Based on the assessment and the resulting comparison matrix $[A]_{5 \times 5}$ of the relative significance of five risk factors affecting the drilling activity, the step by step in the weight calculation is provided by using the fuzzy numbers, the fuzzy evaluation matrix is constructed in the form as given below

$$[A]_{5 \times 5} = \begin{bmatrix} 1.0 & a_{12} & a_{13} & a_{14} & a_{15} \\ a_{21} & 1.0 & a_{23} & a_{24} & a_{25} \\ a_{31} & a_{32} & 1.0 & a_{34} & a_{35} \\ a_{41} & a_{42} & a_{43} & 1.0 & a_{45} \\ a_{51} & a_{52} & a_{53} & a_{54} & a_{55} \end{bmatrix} = \begin{bmatrix} (1,1,1) & \left(\frac{1}{2}, 1, \frac{3}{2}\right) & \left(\frac{1}{2}, 1, \frac{3}{2}\right) & \left(1, \frac{3}{2}, 2\right) & \left(1, \frac{3}{2}, 2\right) \\ \left(\frac{1}{2}, 1, \frac{3}{2}\right) & (1,1,1) & \left(\frac{1}{2}, 1, \frac{3}{2}\right) & \left(1, \frac{3}{2}, 2\right) & \left(1, \frac{3}{2}, 2\right) \\ \left(\frac{1}{2}, 1, \frac{3}{2}\right) & \left(\frac{1}{2}, 1, \frac{3}{2}\right) & (1,1,1) & \left(1, \frac{3}{2}, 2\right) & \left(1, \frac{3}{2}, 2\right) \\ \left(\frac{1}{4}, \frac{3}{4}, \frac{5}{4}\right) & \left(\frac{1}{4}, \frac{3}{4}, \frac{5}{4}\right) & \left(\frac{1}{4}, \frac{3}{4}, \frac{5}{4}\right) & (1,1,1) & \left(\frac{1}{4}, \frac{3}{4}, \frac{5}{4}\right) \\ \left(\frac{1}{4}, \frac{3}{4}, \frac{5}{4}\right) & \left(\frac{1}{4}, \frac{3}{4}, \frac{5}{4}\right) & \left(\frac{1}{4}, \frac{3}{4}, \frac{5}{4}\right) & \left(\frac{1}{4}, \frac{3}{4}, \frac{5}{4}\right) & (1,1,1) \end{bmatrix}$$

Then the weight vector is calculated as follows:

$$S_1 = (2.00, 3.50, 3.50, 3.84, 3.84) \otimes \left(\frac{1}{14.51}, \frac{1}{14.84}, \frac{1}{14.00}, \frac{1}{12.00}, \frac{1}{9.00} \right)$$

$$S_2 = (2.00, 3.50, 2.00, 2.50, 2.50) \otimes \left(\frac{1}{14.51}, \frac{1}{14.84}, \frac{1}{14.00}, \frac{1}{12.00}, \frac{1}{9.00} \right)$$

$$S_3 = (2.00, 2.00, 3.50, 2.50, 2.50) \otimes \left(\frac{1}{14.51}, \frac{1}{14.84}, \frac{1}{14.00}, \frac{1}{12.00}, \frac{1}{9.00} \right)$$

$$S_4 = (2.00, 2.00, 2.50, 3.50, 2.50) \otimes \left(\frac{1}{14.51}, \frac{1}{14.84}, \frac{1}{14.00}, \frac{1}{12.00}, \frac{1}{9.00} \right)$$

$$S_5 = (1.00, 1.00, 2.50, 2.50, 3.17) \otimes \left(\frac{1}{14.51}, \frac{1}{14.84}, \frac{1}{14.00}, \frac{1}{12.00}, \frac{1}{9.00} \right)$$

Using these vectors to find relative weights

$$V(S_1 \geq S_2) = 1.0, V(S_1 \geq S_3) = 1.0, V(S_1 \geq S_4) = 1.0, V(S_1 \geq S_5) = 1.0,$$

$$V(S_2 \geq S_1) = 1.0, V(S_2 \geq S_3) = 1.0, V(S_2 \geq S_4) = 1.0, V(S_2 \geq S_5) = 1.0,$$

$$V(S_3 \geq S_1) = 1.0, V(S_3 \geq S_2) = 1.0, V(S_3 \geq S_4) = 1.0, V(S_3 \geq S_5) = 1.0,$$

$$V(S_4 \geq S_1) = 0.75, V(S_4 \geq S_2) = 0.75, V(S_4 \geq S_3) = 0.75, V(S_4 \geq S_5) = 0.75,$$

$$V(S_5 \geq S_1) = 0.85, V(S_5 \geq S_2) = 0.85, V(S_5 \geq S_3) = 0.85, \text{ and } V(S_5 \geq S_4) = 0.85,$$

Finally, weight of each factor is computed as follows

$$d'(1) = \min(1.00, 1.00, 1.00, 1.00, 1.00) = 1.00$$

$$d'(2) = \min(1.00, 1.00, 1.00, 1.00, 1.00) = 1.00$$

$$d'(3) = \min(1.00, 1.00, 1.00, 1.00, 1.00) = 1.00$$

$$d'(4) = \min(1.00, 1.00, 1.00, 0.75, 1.00) = 0.75$$

$$d'(5) = \min(1.00, 1.00, 1.00, 1.00, 0.85) = 0.85$$

Therefore, $W' = (1.00, 1.00, 1.00, 0.75, 0.85)^T$. The weight vector of the risk factors affecting the tunnel lining installation activity is calculated by normalizing W' . Then, $W = (0.22, 0.22, 0.22, 0.16, 0.18)^T$. Weight vectors of other risk factors affecting other activities can be also computed following steps explained above.

The weights w_k of risk factors are calculated by following steps above. The results are obtained with the consensus of the evaluators as shown in Table 4.2, where R_1 is Late delivery of main equipment for a specific data, R_2 is High water pressure, R_3 is Broken down equipment, R_4 is Heavy rain, and R_5 is Geographic uncertainty. As

the average weight vector represents the most likely values for the calculated comparison structure, the average weight vector is particularly used to represent the weight vectors provided by the experts. Let a_{ij}^k be the fuzzy number (weight) assigned by expert i , or A_i , for the risk factor k , then the average of fuzzy number across all the experts can be expressed as $A_{ij}^k = (1/p) \times (a_{i1}^k + a_{i2}^k + \dots + a_{ip}^k)$, where p = number of experts involved in the evaluation process.

The FAHP method provides a crisp value of weight (relative significance of risk factors) based on the input fuzzy numbers. The resulting weights show that the significant risk factors associated with the operation risk consist of (1) Late delivery of main equipment for a specific data, high water pressure, and broken down equipment, (2) geographic uncertainty, and (3) heavy rain, respectively.

Table 4.2 Relative significance Wt of risk factors affecting Drilling activity

Risk factor	Relative significance of risk factors evaluated by expert i									
	1	2	3	4	5	6	7	...	12	average
R_1	0.22	0.13	0.13	0.13	0.13	0.13	0.13	...	0.13	0.13
R_2	0.22	0.22	0.22	0.22	0.22	0.22	0.22	...	0.22	0.22
R_3	0.22	0.22	0.22	0.22	0.22	0.22	0.22	...	0.22	0.22
R_4	0.16	0.20	0.20	0.20	0.20	0.20	0.20	...	0.20	0.20
R_5	0.18	0.22	0.22	0.22	0.22	0.22	0.22	...	0.22	0.22

4.2.2 Demonstrative Application of Risk Assessment Method

As input data required by the RAIRFNET for the Drilling activity cannot be completely acquired from the historical records, the original definition of $l_{i(j)}$ must be adjusted based on available data. The definition of the likelihood of risk factor j was revised as the total number of units of a bored pile of which duration of the Drilling activity was extended from the duration (initially estimated based on expected conditions) in the selected projects divided by the total number of units of a bored pile in those projects. As mentioned previously, the extended duration does not stem from a particular risk factor, but a set of risk factors combined. In addition, $l_{i(j)}$ of a new project is usually different from $l_{i(j)}$ of the completed projects. The likelihood $P_{i(j)}$ is used to help establish the distribution of $l_{i(j)}$. A number of

assessors were asked to subjectively estimate $P_{i(j)}$. The minimum, mode, and maximum values of $P_{i(j)}$ are used to determine the optimistic, most likely, and pessimistic values of $l_{i(j)}$. The $P_{i(j)}$ values of the significant risk factors affecting the Drilling activity are shown in Table 4.3.

Table 4.3 Assessed values of risk factors $P_{i(j)}$ affecting Drilling activity

Risk factor	Value of risk factors									
	1	2	3	4	5	6	7	...	10	average
R ₁	0.13	0.13	0.14	0.13	0.13	0.19	0.17	...	0.16	0.13
R ₂	0.20	0.25	0.21	0.20	0.20	0.19	0.22	...	0.21	0.22
R ₃	0.27	0.25	0.29	0.27	0.20	0.19	0.17	...	0.21	0.22
R ₄	0.07	0.06	0.07	0.13	0.13	0.13	0.17	...	0.16	0.20
R ₅	0.33	0.31	0.29	0.27	0.33	0.31	0.28	...	0.26	0.22

For example, if the maximum values of $P_{i(j)}$ of geographic uncertainty is “highly likely”, the derived pessimistic likelihood $l_{i(j)} = Wt \times P_{i(j)} \times$ quantitative likelihood = $0.22 \times 0.33 \times 0.85 = 0.06$, where the weight (0.22) of geographic uncertainty is calculated by using the FAHP as presented in Table 4.2, $P_{i(j)}$ is of 0.33 obtained from Table 4.3, the quantitative likelihood is of 0.85 calculated from the redefined equation based on data obtained from five completed projects.

Based on available data from the completed projects, the extended duration of the Drilling activity due to all risk factors comparing to its initially estimated duration cannot be acquired. The subjective evaluation of extended duration was performed by using linguistic terms. The assigned linguistic terms are later transformed into the triangular membership functions. The calculated mean and standard deviation are then used to establish the overall distribution of $E_{i(j)}$. The qualitative consequence $C_{i(j)}$ is also used to help develop the distribution of $E_{i(j)}$ due to each of risk factors.

For example, if the maximum value of $E_{i(j)}$ is “catastrophic” and $C_{i(j)}$ is “very high”, the derived pessimistic consequence $E_{i(j)} = C_{i(j)} \times$ % extended duration for “catastrophic” = $0.90 \times 0.95 = 0.86$. The values of $E_{i(j)}$ and $C_{i(j)}$ are

randomly drawn based on the corresponding triangular distributions. In regard to the impact of the geographic uncertainty, duration of Drilling activity is recalculated from a function of the likelihood of occurrence of geographic uncertainty, the extended duration (%) and the initially estimated duration so that duration of Drilling activity is extended due to the geographic uncertainty: $(0.06 \times 0.86) \times 960 = 51$ minutes, where $l_{i(j)} = 0.06$. It is very communicative and applicable in practice to presenting the assessed value of a risk factor by a corresponding linguistic term. Using the boundaries set for the risk assessment, for example: very high is more than about 5% of a project completion time, high is 3% to 5%, medium is 2% to 3%, low is 1% to 2%, and very low is less than 1%. Thus, for $R_{i(j)} = 0.06$, it means that a risk factor i having impact on an activity j is rated "very high". Table 4.4 presents the calculated values of risk factors for a Drilling activity, where $R_j^* = Wt_j \times P_{i(j)} \times \text{quantitative likelihood} \times C_{i(j)} \times \% \text{ extended duration}$, R_1 is Late delivery of main equipment for a specific data, R_2 is High water pressure, R_3 is Broken down equipment, R_4 is Heavy rain, and R_5 is Geographic uncertainty, k is assessors including project managers, engineers, and foremen. The most likely and minimum values of $E_{i(j)}$ due to the geographic uncertainty and the maximum, most likely and minimum values of $E_{i(j)}$ due to other risk factors can be calculated following the above steps.

Table 4.4 Assessed values of risk factors $R_{i(j)}$ affecting Drilling activity

Risk factor	$R_{k(j)}$										Linguistic term
	1	2	3	4	5	6	7	...	12	average	
R_1	0.03	0.03	0.04	0.3	0.03	0.01	0.07	...	0.06	0.03	medium
R_2	0.03	0.01	0.02	0.02	0.03	0.01	0.03	...	0.06	0.03	medium
R_3	0.07	0.05	0.03	0.07	0.02	0.02	0.07	...	0.03	0.05	very high
R_4	0.03	0.01	0.02	0.02	0.03	0.01	0.03	...	0.06	0.03	medium
R_5	0.02	0.05	0.01	0.04	0.02	0.02	0.02	...	0.03	0.07	very high

The values of the risk factors which reference the values of risk factors to some bored pile construction norms are determined for comparison purposes. As the average value vector represents the most likely values for the assessed risk factors, the

reference value of the risk factor is represented by the average value vector of risk factors. The result is then used to depict the most likely values of the risk factors of the available dataset. The values of the significant risk factors are shown in Table 4.4.

4.2.3 Establishing Distributions of Activity Duration and Risk Variable

The distribution of activity duration affected by each risk factor is established by using the three – point estimation. Conceptually, the distribution of activity duration affected by all risk factors is established by adding the activity duration initially estimated without a consideration about risk factors into the sum of the individual distributions of activity duration affected by risk factors. The proposed method uses simulation to generate data and develops the probability distribution of activity duration affected by risk factors and the probability distribution of risk variables. Activity duration affected by each risk factor is drawn randomly based on its derived distribution. Then, the initially estimated activity duration plus the sum of the activity durations affected by all risk factors is calculated. The obtained result represents the random contribution to uncertainty associated with activity duration. Table 4.5 shows the simulated values of duration and the product of attributes of each risk factor for Drilling, Cage installation, and Concrete pouring activities. To simplify the demonstration of simulated data, only four simulation replications are presented in Table 4.5.

Table 4.5 Simulated data of activity durations and attributes of five significant risk factors

Activity	Simulation replication	Duration	R ₁	R ₂	R ₃	R ₄	R ₅
Drilling	1	14.67	0.01	0.03	0.04	0.01	0.03
	2	14.81	0.02	0.04	0.12	0.02	0.04
	3	14.19	0.01	0.04	0.08	0.01	0.03
	4	14.16	0.01	0.06	0.05	0.01	0.09
	mean	14.76	0.02	0.04	0.06	0.01	0.06
	SD	0.13	0.00	0.01	0.03	0.00	0.02
Cage installation	1	0.75	0.01	0.04	0.06	0.02	0.06
	2	0.69	0.01	0.03	0.05	0.01	0.08
	3	0.75	0.01	0.03	0.07	0.00	0.03
	4	0.78	0.01	0.07	0.08	0.01	0.05
	mean	0.71	0.01	0.04	0.06	0.01	0.05
	SD	0.04	0.00	0.01	0.02	0.00	0.02
Concrete pouring	1	1.72	0.02	0.05	0.09	0.01	0.08
	2	1.64	0.01	0.03	0.06	0.01	0.03
	3	1.65	0.01	0.02	0.06	0.00	0.04
	4	1.72	0.02	0.04	0.06	0.00	0.03
	mean	1.68	0.01	0.04	0.06	0.01	0.05
	SD	0.07	0.00	0.01	0.02	0.00	0.02

4.2.4 Developing Membership Functions of Activity Duration and Risk Variables

The random and nonrandom parts of random-fuzzy variables (i.e., activity duration and risk variables) are represented by membership functions. The membership function representing the random part is transformed from the corresponding probability distribution by using the probability-possibility transformation methods including the Salicone's method and the neurofuzzy metamodel. Table 4.6 shows the transformed membership functions (i.e., nil internal membership function) of activity duration and risk variables disregarding the systematic and unknown effects. Table 4.7 shows membership functions obtained from Salicone's method and neurofuzzy metamodel for nil, rectangular, and trapezoidal internal membership functions. As data are obtained from simulation model, for the sake of comparing the simulation results obtained from the probability distributions and the actual information with the fuzzy numbers, the frequencies of the activity durations are normalized by dividing them with the maximum frequency. To

enable the comparison between the random–fuzzy numbers representing and not representing the systematic and unknown contributions, there are three types of the internal membership function including nil, rectangular, and trapezoidal internal membership functions.

The proposed method uses different types of probability distributions to represent the temporal variables and the risk variables in the simulation model. To simplify the presentation, the product of the triangular distributions of the temporal variable and the risk variables is considered. When a Monte Carlo simulation is performed, it can be seen that the normalized frequency is not symmetric. In other words, the symmetry of each distribution (either for temporal or risk variable) is lost. In addition, the product of the means of the distributions of temporal and risk variables does not fall in the middle of the supports of the obtained normalized frequency. Therefore, the shape of the obtained normalized frequency of the random part of the temporal variable cannot be approximated by a normal distribution.

Membership functions represent activity duration, when the systematic and unknown contributions are considered together with the random contribution. The probability of occurrence for each element of the activity duration can be calculated. The values for the mean and the standard deviations of the durations of project activities can be determined. The statistical form of frequency of activity durations can be used to approximate the probability density function of the activity duration. For comparison, this research uses simulation to generate data related to activity duration based on the parameters of the durations of project activities which are estimates of the mean and standard deviation of duration calculated from the membership functions having nil, rectangular, and trapezoidal internal membership functions.

Table 4.6 Nil membership functions obtained from Salicone's method and neurofuzzy metamodel

Activity	Method	Value	R1	R2	R3	R4	R5	Duration
Drilling	Salicone's method	min	0.00	0.01	0.03	0.00	0.02	14.36
		mean	0.02	0.05	0.06	0.01	0.04	14.76
		max	0.03	0.09	0.15	0.01	0.10	15.17
	Neurofuzzy metamodel	min	0.00	0.01	0.03	0.00	0.02	3.43
		mean	0.02	0.05	0.06	0.01	0.04	14.76
		max	0.02	0.08	0.12	0.04	0.10	28.19
Cage installation	Salicone's method	min	0.00	0.01	0.02	0.01	-0.01	0.58
		mean	0.01	0.04	0.06	0.01	0.05	0.71
		max	0.02	0.08	0.11	0.02	0.11	0.84
	Neurofuzzy metamodel	min	0.00	0.02	0.03	0.00	0.01	0.32
		mean	0.01	0.04	0.06	0.01	0.05	0.71
		max	0.03	0.08	0.10	0.04	0.10	1.16
Concrete pouring	Salicone's method	min	0.00	0.01	0.02	0.01	0.01	1.48
		mean	0.01	0.04	0.06	0.01	0.05	1.68
		max	0.02	0.08	0.11	0.02	0.11	1.89
	Neurofuzzy metamodel	min	0.00	0.01	0.03	0.00	0.02	1.04
		mean	0.01	0.04	0.06	0.01	0.05	1.68
		max	0.03	0.08	0.11	0.03	0.12	2.49
Soil removal	Salicone's method	min	0.00	0.01	0.02	0.01	0.01	0.30
		mean	0.01	0.04	0.07	0.01	0.05	0.82
		max	0.02	0.08	0.11	0.02	0.11	1.34
	Neurofuzzy metamodel	min	0.00	0.01	0.03	0.00	0.02	0.00
		mean	0.01	0.04	0.07	0.01	0.05	0.82
		max	0.03	0.09	0.11	0.03	0.11	5.96

Figure 4.3 to 4.8 present the comparison of simulation results for nil, rectangular, and trapezoidal internal membership functions obtained from the neurofuzzy metamodel and triangular distribution based durations for Drilling activity for a set of risk factors R1, R2, R3, R4, and R5. Conceptually, the simulation results can be reasonably improved by using the revised probability distributions of durations of project activities of which shapes can be dynamically changed according to the existing values of risk variables.



Table 4.7 Membership functions obtained from neurofuzzy metamodel and Salicone's method for nil, rectangular, and trapezoidal internal membership functions (IMF)

Activity	IMF	Salicone's method				Neurofuzzy metamodel			
Drilling	Nil	3.43	14.76	14.76	28.19	14.36	14.76	14.76	15.17
	Rectangular	3.43	14.76	17.76	31.19	14.36	14.76	17.76	18.17
	Trapezoidal	1.43	14.76	17.76	33.19	12.36	14.76	17.76	20.17
Cage installation	Nil	0.32	0.71	0.71	1.16	0.58	0.71	0.71	0.84
	Rectangular	0.32	0.71	1.09	1.55	0.58	0.71	1.09	1.22
	Trapezoidal	- 0.06	0.71	1.09	1.93	0.45	0.71	1.09	1.35
Concrete pouring	Nil	1.04	1.68	1.68	2.49	1.48	1.68	1.68	1.89
	Rectangular	1.04	1.68	2.32	3.13	1.48	1.68	2.32	2.53
	Trapezoidal	0.40	1.68	2.32	3.77	1.27	1.68	2.32	2.73
Soil removal	Nil	0.00	0.82	0.82	5.96	0.30	0.82	0.82	1.34
	Rectangular	0.00	0.82	1.64	6.79	0.30	0.82	1.64	2.17
	Trapezoidal	- 0.82	0.82	1.64	7.61	-0.22	0.82	1.64	2.69

In addition to the comparison between the random-fuzzy numbers and the frequencies of the simulated activity durations which are used to approximate the probability of activity duration, it is interesting to compare the probability of activity duration regarding impact of risk factors within a certain time. Such a probability can be calculated in Monte Carlo simulation using the cumulative probability (CP) and in RAIRFNET using the agreement index (AI) and credibility coefficient (C_{eq}). A number of activity durations for each activity are examined using these three methods. It should be mentioned that CP, AI and C_{eq} are different scales used to describe the uncertainty associated with a given activity duration, although they are comparable. The results shown in Figure 4.9 for the drilling activity indicate the widest range for the activity duration associated with the neurofuzzy metamodel and the smallest range associated with Monte Carlo simulation. The range for the activity duration associated with the Salicone's method is in the middle of those two methods.

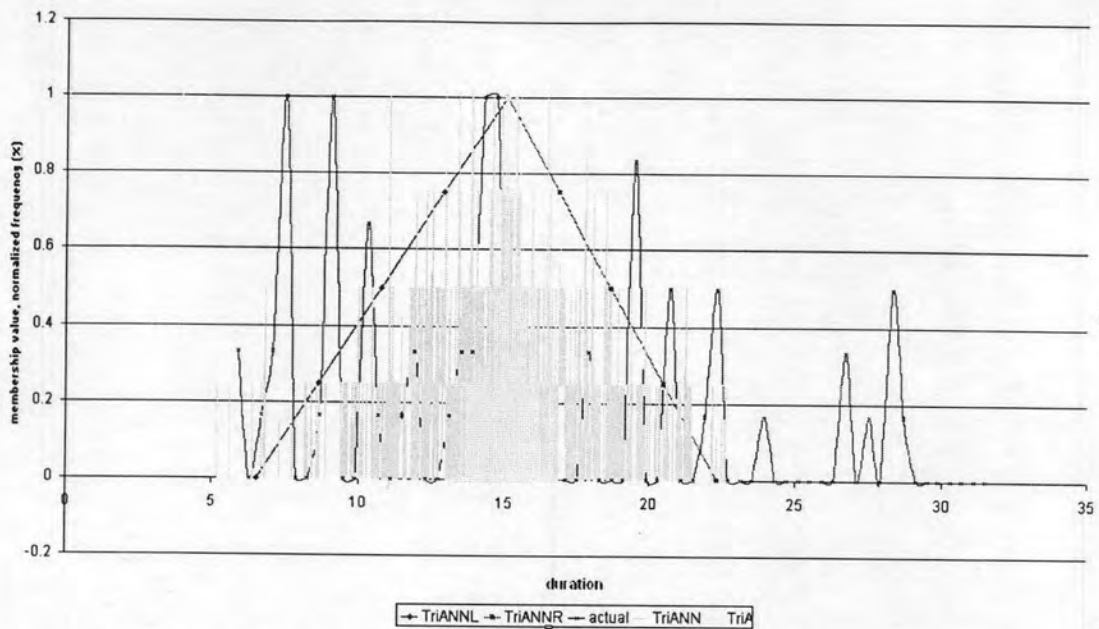

Figure 4.3 Comparison of simulation results for nil internal membership functions obtained from the neurofuzzy metamodel and triangular distribution based durations for Drilling activity for a set of risk factors R_1, R_2, R_3, R_4, R_5

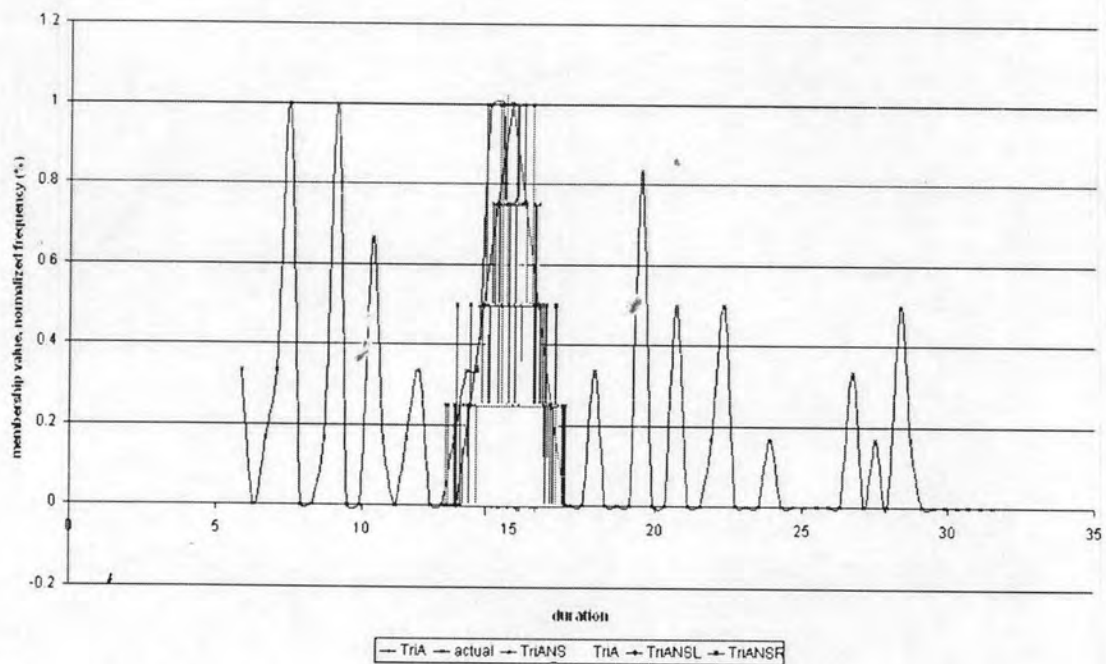

Figure 4.4 Comparison of simulation results for nil internal membership functions obtained from the Salicone's method and triangular distribution based durations for Drilling activity for a set of risk factors R_1, R_2, R_3, R_4, R_5

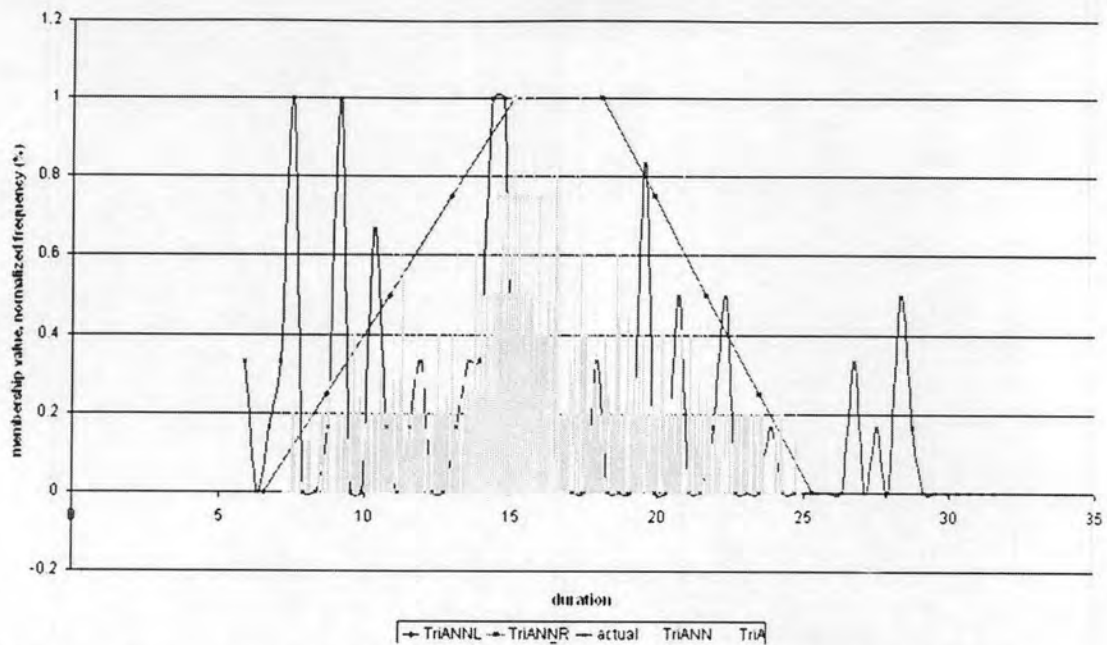

Figure 4.5 Comparison of simulation results for rectangular internal membership functions obtained from the neurofuzzy metamodel and triangular distribution based durations for Drilling activity for a set of risk factors R_1, R_2, R_3, R_4, R_5

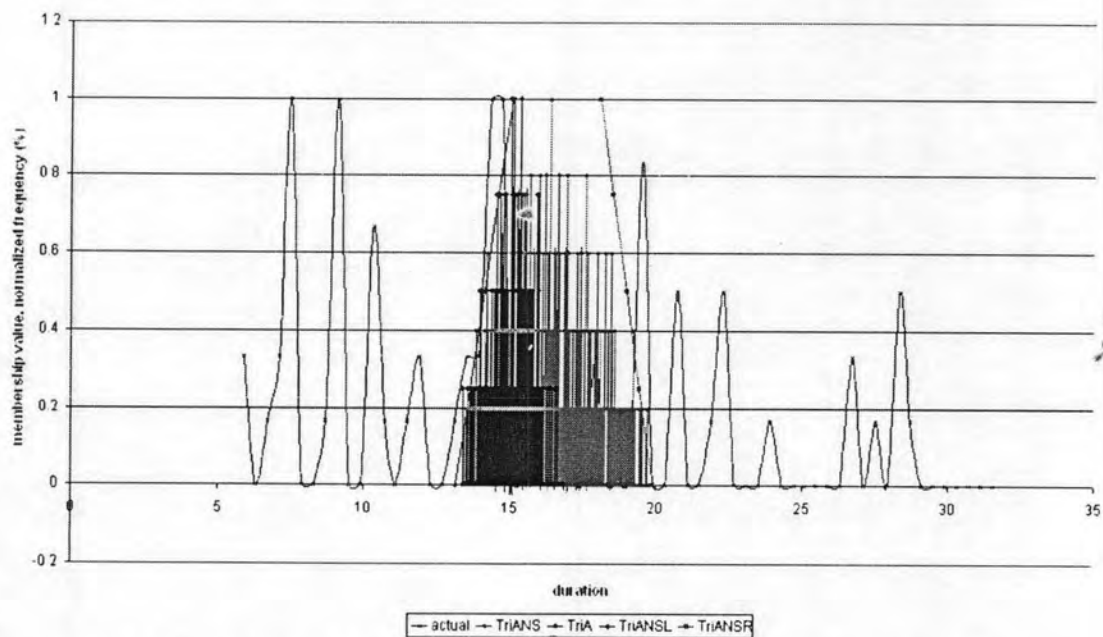

Figure 4.6 Comparison of simulation results for rectangular internal membership functions obtained from the Salicone's method and triangular distribution based durations for Drilling activity for a set of risk factors R_1, R_2, R_3, R_4, R_5

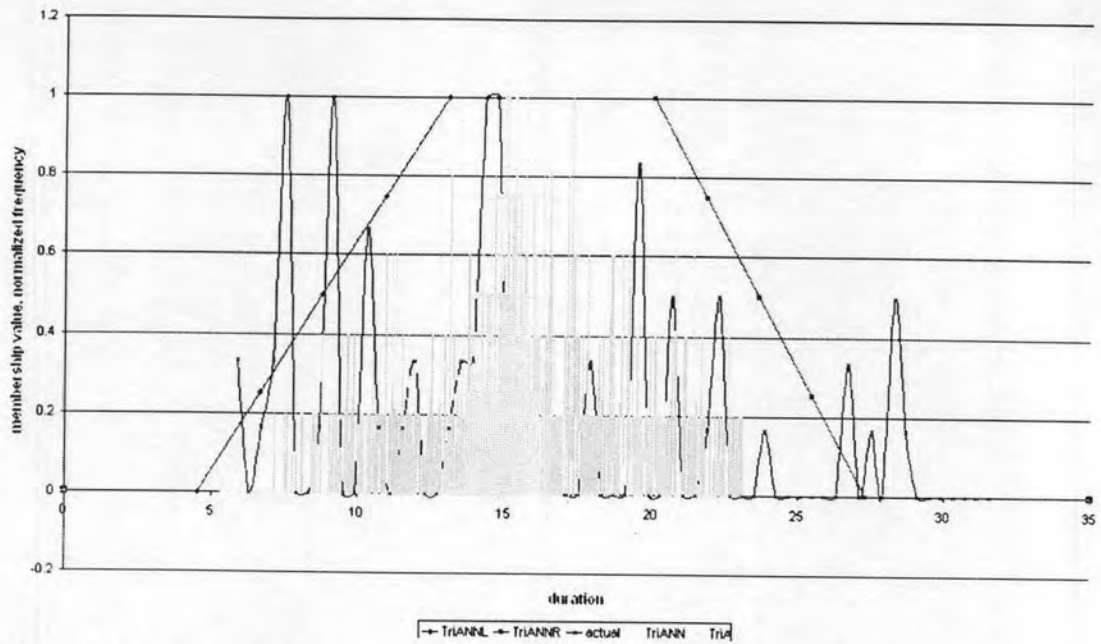

Figure 4.7 Comparison of simulation results for trapezoidal internal membership functions obtained from the neurofuzzy metamodel and triangular distribution based durations for Drilling activity for a set of risk factors R_1, R_2, R_3, R_4, R_5

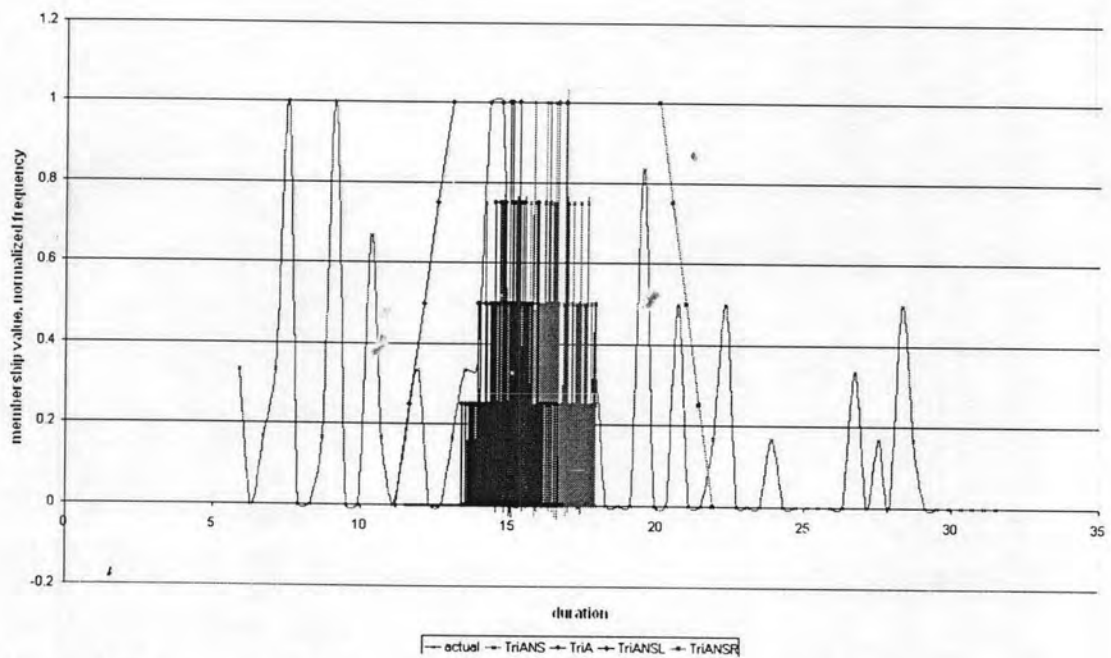

Figure 4.8 Comparison of simulation results for trapezoidal internal membership functions obtained from the Salicone's method and triangular distribution based durations for Drilling activity for a set of risk factors R_1, R_2, R_3, R_4, R_5

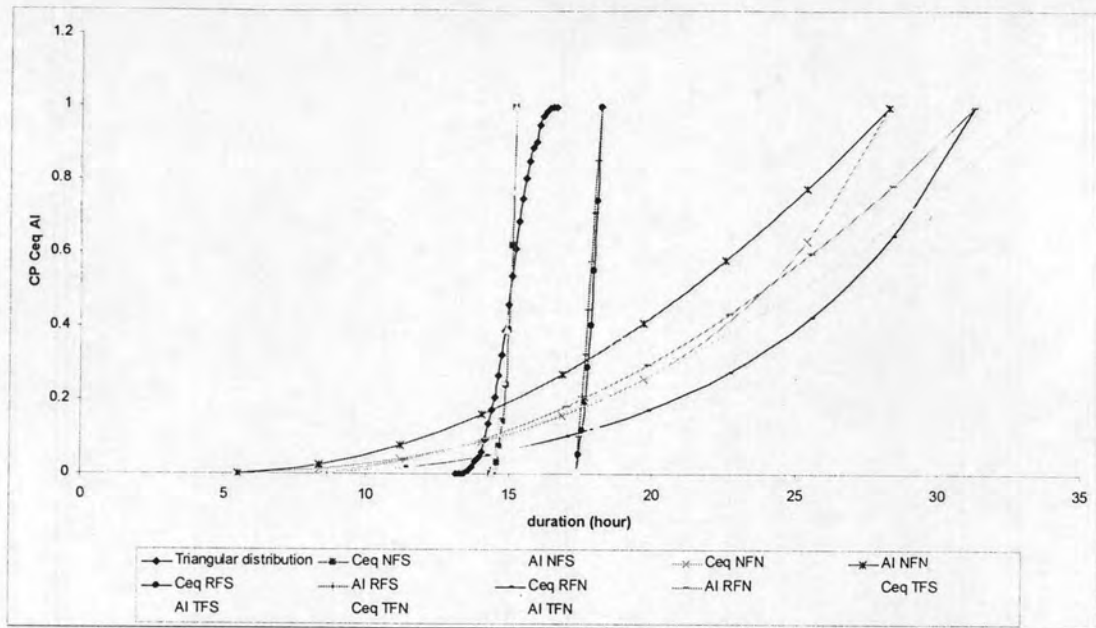

Figure 4.9 Comparison of CP with AI and C_{eq} obtained from the neurofuzzy metamodel and Salicone's method for Drilling activity

In the Salicone's method, the estimated optimistic and pessimistic activity durations showing the spread of the activity duration are considered as three times of the spread of the activity duration obtained from the Monte Carlo simulation based on its mean and standard deviation. Thus, the standard deviation calculated for activity duration is smaller than the difference between the optimistic and pessimistic values or the spread of random-fuzzy duration. The spreads of random-fuzzy durations obtained from these two methods depend on mean and standard deviation. The uncertainty inherent in the input data learnt by the neurofuzzy metamodel controls the spread of random-fuzzy duration.

Table 4.8 Calculated random-fuzzy start and finish times for the 65th unit of a bored pile project

M	α	ES			EF			LF			LS		
NS	1	1115	1115	1115	1115	1115	1115	1115	1115	1115	1115	1115	1115
NS	0	1044	1115	1186	1044	1115	1186	1044	1115	1186	1044	1115	1186
RS	1	1139	1139	1410	1139	1410	1410	1139	1410	1410	1139	1410	1410
RS	0	1067	1139	1410	1067	1410	1481	1067	1139	1410	1067	1139	1481
TS	1	1139	1139	1410	1139	1410	1410	1139	1410	1410	1139	1410	1410
TS	0	936	1139	1613	936	1410	1613	936	1139	1410	936	1139	1613
NN	1	1115	1115	1115	1115	1115	1115	1115	1115	1115	1115	1115	1115
NN	0	393	1115	1848	393	1115	1848	393	1115	1848	393	1115	1848
RN	1	1139	1139	1410	1139	1410	1410	1139	1410	1410	1139	1410	1410
RN	0	416	1139	2143	416	1410	2143	416	1139	1410	416	1139	2143
TN	1	1139	1139	1410	1139	1410	1410	1139	1410	1410	1139	1410	1410
TN	0	246	1139	2315	246	1410	2315	246	1139	1410	246	1139	2315

Note ES is early start, EF is early finish, LF is late finish, LS is late start, M is methods including NS (nil internal membership function for Salicone's method), NN (nil internal membership function for neurofuzzy metamodel), RS (rectangular internal membership function for Salicone's method), RN (rectangular internal membership function for neurofuzzy metamodel), TS (trapezoidal internal membership function for Salicone's method), TN (trapezoidal internal membership function for neurofuzzy metamodel)

4.2.5 RAIRFNET Calculation

This subsection is to discuss the step – by – step the network calculations performed using RAIRFNET and interpret the random fuzzy results. To compare the results of the RAIRFNET method using the Salicone's method to develop the membership function of activity duration and the RAIRFNET using the neurofuzzy metamodel to develop the membership function of activity duration, the random–fuzzy numbers of activity durations are established by applying these two methods to the same set of simulation data. Table 4.8 presents the calculated fuzzy start and finish times for the 65th unit of a bored pile for all activities based on the activity durations obtained from the Salicone's method and the neurofuzzy metamodel for nil, rectangular, and trapezoidal internal membership functions at α – cut = 1. The random–fuzzy early finish times for the 65th unit of a bored pile for four main activities which are obtained from the RAIRFNET using Salicone's method and the RAIRFNET using neurofuzzy metamodel for nil, rectangular, and trapezoidal internal membership functions are summarized in Table 4.9.

In order to demonstrate how these results are obtained, the calculations performed on a selected activity (i.e., Cage installation activity) are presented. In the forward pass calculations, using Eq. 3.29 to 3.101, for the first unit of a bore pile, FES_4 takes the value (minute) from the FES_2 (i.e., Drilling activity) to be (14.36,14.76,15.17). The FEF_4 can then be calculated by adding its duration (0.58,0.71,0.84) to (14.36,14.76,15.17) to become (14.94,15.47,16.01) hours.

By definition, the mean value of a random fuzzy number FES_2 and FES_4 or A and B are determined as the mean value of the α – cut at level $\alpha = 1$; that is,

$$\mu_A = \frac{a_2^{\alpha=1} + a_3^{\alpha=1}}{2} = \frac{14.76 + 14.76}{2} = 14.76$$

$$\mu_B = \frac{b_2^{\alpha=1} + b_3^{\alpha=1}}{2} = \frac{0.71 + 0.71}{2} = 0.71$$

Under the hypothesis of rectangular internal membership function, the semi – width of this last one is

$$w_A = \frac{a_2^{\alpha=1} - a_3^{\alpha=1}}{2} = \frac{14.76 - 14.76}{2} = 0$$

$$w_B = \frac{b_2^{\alpha=1} - b_3^{\alpha=1}}{2} = \frac{0.71 - 0.71}{2} = 0$$

Table 4.9 The random-fuzzy early finish times (day) for the 65th unit of a bored pile project for four main activities

α	M	DRI				CAG				CON				SOI			
0.00	NS	40	49	60	69	40	49	60	69	40	49	61	69	40	49	61	69
	NN	17	48	48	79	17	48	48	79	17	48	48	79	17	48	48	79
	RS	46	49	60	63	46	49	60	64	46	49	61	64	46	49	61	64
	RN	18	49	60	92	18	49	60	92	18	49	61	92	18	49	61	92
	TS	40	49	60	69	40	49	60	69	40	49	61	69	40	49	61	69
	TN	10	49	60	99	10	49	60	99	10	49	61	99	10	49	61	100
0.25	NS	48	48	48	48	48	48	48	48	48	48	48	48	48	48	48	48
	NN	47	48	48	48	47	48	48	48	48	48	48	48	48	48	48	48
	RS	49	49	60	60	49	49	60	61	49	49	61	61	49	49	61	61
	RN	48	49	60	61	48	49	60	61	49	49	61	61	49	49	61	61
	TS	49	49	60	61	49	49	60	61	49	49	61	61	49	49	61	61
	TN	48	49	60	61	48	49	60	61	48	49	61	61	48	49	61	61
0.50	NS	48	48	48	48	48	48	48	48	48	48	48	48	48	48	48	48
	NN	48	48	48	48	48	48	48	48	48	48	48	48	48	48	48	48
	RS	49	49	60	60	49	49	60	61	49	49	61	61	49	49	61	61
	RN	49	49	60	61	49	49	60	61	49	49	61	61	49	49	61	61
	TS	49	49	60	60	49	49	60	61	49	49	61	61	49	49	61	61
	TN	49	49	60	61	49	49	60	61	49	49	61	61	49	49	61	61
0.75	NS	48	48	48	48	48	48	48	48	48	48	48	48	48	48	48	48
	NN	48	48	48	48	48	48	48	48	48	48	48	48	48	48	48	48
	RS	49	49	60	60	49	49	60	60	49	49	61	61	49	49	61	61
	RN	49	49	60	61	49	49	60	61	49	49	61	61	49	49	61	61
	TS	49	49	60	60	49	49	60	61	49	49	61	61	49	49	61	61
	TN	49	49	60	61	49	49	60	61	49	49	61	61	49	49	61	61
1.00	NS	48	48	48	48	48	48	48	48	48	48	48	48	48	48	48	48
	NN	48	48	48	48	48	48	48	48	48	48	48	48	48	48	48	48
	RS	49	49	60	60	49	49	60	60	49	49	61	61	49	49	61	61
	RN	49	49	60	60	49	49	60	60	49	49	61	61	49	49	61	61
	TS	49	49	60	60	49	49	60	60	49	49	61	61	49	49	61	61
	TN	49	49	60	60	49	49	60	60	49	49	61	61	49	49	61	61

Hence, the α - cuts of the pure random part of the given FES_2 are

$$\left[a_1^\alpha + w_A; a_4^\alpha - w_A \right] = \left[a_1^\alpha; a_4^\alpha \right] = [14.4; 15.2], \left[b_1^\alpha + w_A; b_4^\alpha - w_A \right] = \left[b_1^\alpha; b_4^\alpha \right] = [0.58; 0.84].$$

Then, the part of each α - cut associated with the pure random contributions is represented by the following:

$$a_{r1}^\alpha = a_1^\alpha + w_A = a_{r1}^\alpha = 14.36$$

$$a_{r4}^\alpha = a_4^\alpha + w_A = a_{r4}^\alpha = 15.17$$

$$b_{r1}^\alpha = b_1^\alpha + w_A = b_{r1}^\alpha = 0.58$$

$$b_{r4}^{\alpha} = b_4^{\alpha} + w_A = b_{r4}^{\alpha} = 0.84$$

Then,

$$c_2^{\alpha} = a_2^{\alpha} + b_2^{\alpha} = 14.76 + 0.71 = 15.47$$

$$c_3^{\alpha} = a_3^{S,\alpha} + b_3^{\alpha} = 14.76 + 0.71 = 15.47$$

$$\begin{aligned} c_1^{\alpha} &= c_2^{\alpha} - \mu_c + k \cdot \text{ext}(a_{r1}^{\alpha} + b_{r1}^{\alpha}, g_1^{\alpha}) + (1-k) \cdot \text{int}(a_{r1}^{\alpha} + b_{r1}^{\alpha}, g_1^{\alpha}) \\ &= 15.47 - 15.47 + \frac{1}{\sqrt{2}} \cdot \left(\frac{1}{\sqrt{2}} \cdot (14.36 + 0.58) + \left(1 - \frac{1}{\sqrt{2}}\right) \cdot 14.94 \right) \\ &+ \left(1 - \frac{1}{\sqrt{2}}\right) \cdot (14.36 + 0.58), \text{ and} \end{aligned}$$

$$\begin{aligned} c_4^{\alpha} &= c_3^{\alpha} - \mu_c + k \cdot \text{ext}(a_{r4}^{\alpha} + b_{r4}^{\alpha}, g_4^{\alpha}) + (1-k) \cdot \text{int}(a_{r4}^{\alpha} + b_{r4}^{\alpha}, g_4^{\alpha}) \\ &= 15.51 - 15.51 + \frac{1}{\sqrt{2}} \cdot \left(\frac{1}{\sqrt{2}} \cdot (15.17 + 0.84) + \left(1 - \frac{1}{\sqrt{2}}\right) \cdot 16.05 \right) \\ &+ \left(1 - \frac{1}{\sqrt{2}}\right) \cdot (15.17 + 0.84) \end{aligned}$$

where μ_c is the mean value of the sum:

$$\mu_c = \frac{c_2^{\alpha=1} + c_3^{\alpha=1}}{2} = \frac{15.51 + 15.51}{2} = 15.51$$

k is a constant

$$k = \frac{1}{\sqrt{2}}$$

and $[g_1^{\alpha}, g_4^{\alpha}]$ is the generic α -cut of the normal possibility distribution, having a mean value μ_c and standard deviation:

$$\begin{aligned} \sigma &= \min\{\mu_c - a_{r1}^{\alpha=0} - b_{r1}^{\alpha=0}; a_{r4}^{S,\alpha=0} + b_{r4}^{\alpha=0} - \mu_c\} \\ &= \min\{15.51 - 14.36 - 0.58; 15.17 + 0.84 - 15.51\} = \min\{0.53; 0.54\} = 0.54 \end{aligned}$$

$$g_1^{\alpha} = \mu_c - \sigma = 14.94$$

$$g_4^{\alpha} = \mu_c + \sigma = 16.05$$

The fuzzy duration for one unit of a bored pile resulting from the forward pass calculation is taken as the FEF_8 to be (16.76, 17.70, 18.65) hours which can be interpreted as: approximately 18 hours, with a definite minimum and maximum times

of 17 and 19 hours, respectively. Other scheduling results can be interpreted in the same way.

For the backward pass calculations, the computations for the late times of each activity start with the calculation of its preliminary late finish (PLF). As for the case of Concrete pouring activity, PLF_5 takes the smallest FLS of its successors (i.e., Changing machine position activity, and Spoil removal activity). The smallest FLS is (16, 17.15, 18.30). FLF_5'' can be calculated using PLF_5 to be $(-\infty, 16.57, 18.34)$ hours. Then, the FLF_5 is computed. Firstly, a more uncertain event between the FLF_{11}'' and FEF_5 . It can be observed that the right spread of FEF_5 is more uncertain (i.e., $(36-18) > (31-18)$). After that, FLF_5 and ${}_3FLS$ are computed: $(-0.87, 11.49, 24.83)$ and $(-3.36, 9.82, 23.62)$, respectively.

To enable the comparison between results based FNET and RAIRFNET methods for different α – cut levels, the calculated early finish times obtained from these two methods are compared to the simulated early finish times provided by executing simulation for 20 runs on 65 units of a bored pile. Table 4.10 and 4.11 present the comparing results which are the maximum and minimum differences between results based FNET and RAIRFNET methods using the Salicone's method and the neurofuzzy metamodeling method to transform the probability distributions into the possibility distributions and result obtained from simulation at the same confidence levels or α – cut levels.

The α – cut levels could range anywhere between 0 and 1, in which the higher α – cut contains a smaller range of time values as compared to that of the lower levels. It means that the lower the α – cut levels will be presented, the more uncertain the schedule will be obtained. For simplicity, the calculation is performed on the α – cut levels including 0, 0.25, 0.50, 0.75, and 1. The interpolations are then performed for the α – cut levels included in each interval. It can be investigated that the RAIRFNET provides the shorter project completion times than the one obtained by using the FNET for α – cut = 0.25, 0.50, and 0.75. The project completion time calculated by using the RAIRFNET method is closer to the one obtained by using the FNET, when the α – cut increases.

Owing to the internal mechanism of the mathematics for random-fuzzy variables based the RAIRFNET method using the Salicone's method, only one time

of the network calculation is sufficient when using random-fuzzy durations of project activities. Similar to the RAIRFNET using the neurofuzzy metamodel, the computation of the project duration can be performed by only one time of the network calculation.

Table 4.10 Maximum and minimum differences between durations (quadruple) obtained from FNET and RAIRFNET methods using the Salicone's method and simulation

α – cut	1.00		0.75		0.50		0.25		0.00	
	max	min	max	min	max	min	max	min	max	min
NSa	79.82	-1.67	79.67	-1.55	79.79	-1.41	80.69	-1.22	62.09	-16.38
NSb	79.82	-1.67	79.82	-1.67	79.82	-1.67	79.82	-1.67	79.82	0.46
NSc	79.82	-1.67	79.82	-1.67	79.82	-1.67	79.82	-1.67	122.94	24.21
NSd	79.82	-1.67	86.33	-1.80	92.42	-1.94	97.57	-2.15	157.87	40.17
NFa	79.82	-1.67	47.92	-1.82	15.92	-11.99	11.75	-37.37	62.09	-16.38
NFb	79.82	-1.67	79.82	-1.67	79.82	-1.67	79.82	-1.67	79.82	0.46
NFc	79.82	-1.67	79.82	-1.67	79.82	-1.67	79.82	-1.67	122.94	24.21
NFd	79.82	-1.67	120.05	-1.49	158.96	-1.37	195.71	-1.32	157.87	40.17
RSa	79.82	0.46	79.67	0.60	79.79	0.76	80.69	0.98	92.10	-4.43
RSb	79.82	0.46	79.82	0.46	79.82	0.46	79.82	0.46	79.82	0.46
RSc	122.94	24.21	122.94	24.21	122.94	24.21	122.94	24.21	122.94	24.21
RSd	122.94	24.21	128.39	24.05	133.37	23.87	137.30	23.63	129.96	28.68
RFa	79.82	0.46	47.92	0.36	15.92	-11.99	11.75	-37.37	92.10	-4.43
RFb	79.82	0.46	79.82	0.46	79.82	0.46	79.82	0.46	79.82	0.46
RFc	122.94	24.21	122.94	24.21	122.94	24.21	122.94	24.21	122.94	24.21
RFd	122.94	24.21	162.10	24.36	199.91	24.49	235.44	24.52	129.96	28.68
TSa	79.82	0.46	39.79	0.32	14.08	-25.38	8.96	-57.67	-76.94	-91.78
TSb	79.82	0.46	79.82	0.46	79.82	0.46	79.82	0.46	79.82	0.46
TSc	122.94	24.21	122.94	24.21	122.94	24.21	122.94	24.21	122.94	24.21
TSd	122.94	24.21	169.48	24.41	214.49	24.58	256.93	24.65	279.60	100.33
TFa	79.82	0.46	72.92	0.56	66.11	0.68	59.79	0.85	-76.94	-91.78
TFb	79.82	0.46	79.82	0.46	79.82	0.46	79.82	0.46	79.82	0.46
TFc	122.94	24.21	122.94	24.21	122.94	24.21	122.94	24.21	122.94	24.21
TFd	122.94	24.21	134.62	24.10	145.68	23.97	155.45	23.78	279.60	100.33

Note S represents the application of the RAIRFNET method using the Salicone's method; N, R, and T represent nil, rectangular, and trapezoidal membership functions of fuzzy numbers; a, b, c, d are durations expressed in the form of quadruples, F represents the application of the FNET method.

Table 4.11 Maximum and minimum differences between durations (quadruple) obtained from FNET and RAIRFNET methods using the neurofuzzy metamodeling method and simulation

α - cut	1.00	1.00	0.75	0.75	0.50	0.50	0.25	0.25	0.00	0.00
Method	max	min	max	min	max	min	max	min	max	min
NFa	79.82	-1.67	16.17	-2.10	-47.95	-22.57	-57.20	-73.52	-49.14	-69.94
NFb	79.82	-1.67	79.82	-1.67	79.82	-1.67	79.82	-1.67	79.82	-1.67
NFc	79.82	-1.67	79.82	-1.67	79.82	-1.67	79.82	-1.67	79.82	-1.67
NFd	79.82	-1.67	153.76	-1.19	225.50	-0.80	293.85	-0.49	215.95	59.91
NNa	79.82	-1.67	47.92	-1.82	15.92	-11.99	11.75	-37.37	-49.14	-69.94
NNb	79.82	-1.67	79.82	-1.67	79.82	-1.67	79.82	-1.67	79.82	-1.67
NNc	79.82	-1.67	79.82	-1.67	79.82	-1.67	79.82	-1.67	79.82	-1.67
NNd	79.82	-1.67	120.05	-1.49	158.96	-1.37	195.71	-1.32	215.95	59.91
RFa	79.82	0.46	16.17	0.13	-47.95	-24.74	-57.20	-75.73	-49.14	-69.94
RFb	79.82	0.46	79.82	0.46	79.82	0.46	79.82	0.46	79.82	0.46
RFc	122.94	24.21	122.94	24.21	122.94	24.21	122.94	24.21	122.94	24.21
RFd	122.94	24.21	195.81	24.68	266.46	25.10	333.57	25.40	252.72	85.47
RNa	79.82	0.46	47.92	0.36	15.92	-11.99	11.75	-37.37	-49.14	-69.94
RNb	79.82	0.46	79.82	0.46	79.82	0.46	79.82	0.46	79.82	0.46
RNc	122.94	24.21	122.94	24.21	122.94	24.21	122.94	24.21	122.94	24.21
RNd	122.94	24.21	162.10	24.36	199.91	24.49	235.44	24.52	252.72	85.47
TFa	79.82	0.46	106.06	0.79	118.14	26.74	110.63	59.37	62.09	-16.38
TFb	79.82	0.46	79.82	0.46	79.82	0.46	79.82	0.46	79.82	0.46
TFc	122.94	24.21	122.94	24.21	122.94	24.21	122.94	24.21	122.94	24.21
TFd	122.94	24.21	99.77	23.79	76.88	23.36	53.98	22.91	152.67	40.16
TNa	79.82	0.46	72.92	0.56	66.11	0.68	59.79	0.85	62.09	-16.38
TNb	79.82	0.46	79.82	0.46	79.82	0.46	79.82	0.46	79.82	0.46
TNc	122.94	24.21	122.94	24.21	122.94	24.21	122.94	24.21	122.94	24.21
TNd	122.94	24.21	134.62	24.10	145.68	23.97	155.45	23.78	152.67	40.16

Note N represents the application of the RAIRFNET method using the neurofuzzy metamodel method; N, R, and T represent nil, rectangular, and trapezoidal membership functions of fuzzy numbers; a, b, c, d are durations expressed in the form of quadruples, F represents the application of the FNET method.

To simplify the illustration of the comparison between project completion times represented by the random-fuzzy numbers obtained from the RAIRFNET using Salicone's method to develop the membership function and the RAIRFNET using neurofuzzy metamodel to develop the membership function within a certain time, the criticality of project activities is computed. Table 4.12 presents the credibility coefficients C_{gr} , C_{in} , and C_{eq} , and AI for network paths which are calculated by utilizing the RAIRFNET using Salicone's method and the RAIRFNET using neurofuzzy metamodel for nil, rectangular, and trapezoidal internal membership

functions of durations, where S is Salicone's method, N is neurofuzzy metamodel, and N, R, and T are nil, rectangular, and trapezoidal internal membership function.

It can be seen from Table 4.12 that the values of the C_{eq} and AI probably equal to 1.0. For both RAIRFNET using Salicone's method and RAIRFNET using neurofuzzy metamodel, some paths contain high C_{eq} and AI values which indicates that there are more than one nearly – critical path. Most values of C_{eq} and AI are consistent. Path 1 is considered to be the most critical (i.e., AI = 0.99, C_{eq} = 0.94). Other useful information which cannot be obtained from AI but C_{gr} and C_{lo} can explain how much the path durations higher or lower than the critical path or other paths.

In this case, fuzzy duration of path 2 can be considered as either higher or lower than the designed project completion time and duration of path 1. Comparing duration of path 2 with the project completion time, the value of AI equals to the value of C_{eq} (0.87) because the fuzzy duration of path 2 contains the fuzzy project completion time. The $C_{gr} = 0.12$ shows the degree of belief that the fuzzy duration of path 2 is higher than the designed project completion time, while the $C_{lo} = 0.01$ presenting the degree of belief that the fuzzy duration of path 2 is lower than the designed project completion time. Comparing durations of path 1 and 2, the value of AI and C_{eq} is of 0.83, $C_{gr} = 0.17$, and $C_{lo} = 0.002$, respectively. Path 3 and 4 exhibit less criticality than the former two paths. A project manager should therefore keep a watchful eye on the activities on path 1 and 2.

The credibility coefficients and AI are able to present the critical activities as presented in Table 4.13. For the criticality at the activity level, the Concrete pouring activity is used to provide a demonstrative example. The Concrete pouring activity is presented on every path. The variation of credibility coefficients due to the variation of the relative position of the fuzzy path duration and fuzzy project completion time can be regarded as membership functions, which represent the degrees of belief associated with the statements that the durations of considered paths are greater, lower, or equal to the designed project completion time or how much degree that the current activity is ahead of schedule, behind schedule.

Table 4.12 Criticality measures for network paths of the first unit of a bored pile project

Method	IMF	path	activity			path duration				Credibility coefficient				AI			
						a1	a2	a3	a4	$C_{lo}(A, B)$	$C_{gr}(A, B)$	$C_{eq}(A, B)$					
S	(2)	N	3	1	3	5	6	8	1.7	2.94	2.94	4.42	4.42	1	0	0	0
S		N	1	1	2	4	5	6	5.13	17.7	17.7	32.6	32.6	0.06	0	0.94	0.99
S		N	2	1	2	4	5	7	4.79	18	18	37.8	37.8	0.01	0.12	0.87	0.87
S		N	4	1	3	5	7	8	1.36	3.21	3.21	9.62	9.62	0.99	0	0.01	0.03
S		R	3	1	3	5	6	8	1.7	2.94	32.9	34.4	34.4	1	0	0	0
S		R	1	1	2	4	5	6	5.13	17.7	57.7	72.6	72.6	0.27	0	0.37	1
S		R	2	1	2	4	5	7	4.79	18	58	77.8	77.8	0	0.74	0.25	0.25
S		R	4	1	3	5	7	8	1.36	3.21	33.2	39.6	39.6	0.98	0	0.02	0.03
S		T	3	1	3	5	6	8	0	2.94	2.94	34.4	34.4	1	0	0	0
S		T	1	1	2	4	5	6	0	17.7	17.7	72.6	72.6	0.02	0	0.98	0.63
S		T	2	1	2	4	5	7	0	18	18	77.8	77.8	0.36	0.39	0.25	0.25
S		T	4	1	3	5	7	8	0	3.21	3.21	39.6	39.6	0.99	0	0.01	0.01
N		N	3	1	3	5	6	8	2.4	2.94	2.94	3.49	3.49	1	0	0	0
N		N	1	1	2	4	5	6	16.8	17.7	17.7	18.7	18.7	0.4	0	0.6	0.86
N		N	2	1	2	4	5	7	16.7	18	18	19.2	19.2	0.02	0.01	0.97	0.97
N		N	4	1	3	5	7	8	2.36	3.21	3.21	4.07	4.07	0.16	0	0.20	0.35
N		R	3	1	3	5	6	8	2.4	2.94	32.9	33.5	33.5	1	0	0	0
N		R	1	1	2	4	5	6	16.8	17.7	57.7	58.7	58.7	0.29	0	0.30	1
N		R	2	1	2	4	5	7	16.7	18	58	59.2	59.2	0	0.97	0.03	0.03
N		R	4	1	3	5	7	8	2.36	3.21	33.2	34.1	34.1	0.85	0	0.15	0.14
N		T	3	1	3	5	6	8	0	2.94	2.94	33.5	33.5	1	0	0	0
N		T	1	1	2	4	5	6	0	17.7	17.7	58.7	58.7	0.03	0	0.97	0.51
N		T	2	1	2	4	5	7	0	18	18	59.2	59.2	0.49	0.49	0.03	0.03
N		T	4	1	3	5	7	8	0	3.21	3.21	34.1	34.1	0.99	0	0.01	0.01

Table 4.13 AI and credibility coefficients C_{gr} , C_{lo} , and C_{eq} for network paths and project activities

method	indicator	path	STR	DRI	TRI	CAG	CON	CHA	SOI	END
Salicone's method	AI	1	0.99	0.99		0.99	0.99	0.99		0.99
		2	0.87	0.87		0.87	0.87		0.87	0.87
		3	0.00		0.00		0.00	0.00		0.00
		4	0.03		0.03		0.03		0.03	0.03
		sum	1.89	1.86	0.03	1.86	1.89	0.99	0.90	1.89
	C_{eq}	1	0.94	0.94		0.94	0.94	0.94		0.94
		2	0.87	0.87		0.87	0.87		0.87	0.87
		3	0.00		0.00		0.00	0.00		0.00
		4	0.01		0.01		0.01		0.01	0.01
		sum	1.81	1.81	0.01	1.81	1.81	0.94	0.87	1.81
	C_{gr}	1	0.00	0.00		0.00	0.00	0.00		0.00
		2	0.12	0.12		0.12	0.12		0.12	0.12
		3	0.00		0.00		0.00	0.00		0.00
		4	0.00		0.00		0.00		0.00	0.00
		sum	0.12	0.12	0.00	0.12	0.12	0.00	0.12	0.12
C_{lo}	1	0.06	0.06		0.06	0.06	0.06		0.06	
	2	0.01	0.01		0.01	0.01		0.01	0.01	
	3	1.00		1.00		1.00	1.00		1.00	
	4	0.99		0.99		0.99		0.99	0.99	
	sum	2.06	0.07	1.99	0.07	2.06	1.06	1.00	2.06	
neurofuzzy metamodel	AI	1	0.86	0.86		0.86	0.86	0.86		0.86
		2	0.97	0.97		0.97	0.97		0.97	0.97
		3	0.00		0.00		0.00	0.00		0.00
		4	3.59		3.59		3.59		3.59	3.59
		sum	5.42	1.83	3.59	1.83	5.42	0.86	4.56	5.42
	C_{eq}	1	0.60	0.60		0.60	0.60	0.60		0.60
		2	0.97	0.97		0.97	0.97		0.97	0.97
		3	0.00		0.00		0.00	0.00		0.00
		4	0.60		0.60		0.60		0.60	0.60
		sum	2.17	1.57	0.60	1.57	2.17	0.60	1.57	2.17
	C_{gr}	1	0.00	0.00		0.00	0.00	0.00		0.00
		2	0.01	0.01		0.01	0.01		0.01	0.01
		3	0.00		0.00		0.00	0.00		0.00
		4	0.00		0.00		0.00		0.00	0.00
		sum	0.01	0.01	0.00	0.01	0.01	0.00	0.01	0.01
	max	0.01	0.01	0.00	0.01	0.01	0.00	0.01	0.01	

Table 4.13 AI and credibility coefficients C_{gr} , C_{lo} , and C_{eq} for network paths and project activities (con't)

method	indicator	path	STR	DRI	TRI	CAG	CON	CHA	SOI	END
	C_{lo}	1	0.40	0.40		0.40	0.40	0.40		0.40
		2	0.02	0.02		0.02	0.02		0.02	0.02
		3	1.00		1.00		1.00	1.00		1.00
		4	1.60		1.60		1.60		1.60	1.60
		sum	3.01	0.42	2.60	0.42	3.01	1.40	1.61	3.01
		max	1.60	0.40	1.60	0.40	1.60	1.00	1.60	1.60

Note: STR is Start, DRI is Drilling, TRI is Tremie installation, CAG is Cage installation, CON is Concrete pouring, CHA is Changing machine position, SOI is Soil removal, and END is Finish.

The membership functions of the values of the credibility coefficients can be employed in fuzzy inference in order for a decision maker to seek the critical activities, whenever the criticality of an activity presented on more than one path is considered. In this way, the calculation of the criticality at the activity level is systematically and logically provided. For the first unit of a bored pile, the membership values of $C_{eq}(A, B)$ from path 1, 2, 3, and 4 obtained by applying the RAIRFNET using the Salicone's method for the nil internal membership functions are 0.94, 0.87, 0, and 0.01, respectively. Using the maximum operation, the criticality of this activity is 0.94.

The cumulative degree of criticality provides other useful information which can be derived from either the credibility coefficients or AI. It can present the degree for being a bottle-neck activity which can later affect the project schedule. The project manager should pay attention to activities having higher cumulative criticality values as their delays can significantly affect the project completion time.

For the Concrete pouring activity having the highest cumulative AI, and the highest cumulative C_{eq} , the cumulative AI decreases and become significantly lower than the cumulative C_{eq} when the activity duration is more uncertain (in the case of rectangular and trapezoidal internal membership function), which shows that the use of the credibility coefficients are more appropriate for a general case.

To enable the comparisons between the cases that the internal membership function is nil, rectangular or trapezoidal which are obtained from the RAIRFNET

using Salicone's method and the RAIRFNET using neurofuzzy metamodel, the calculation of the cumulative degree of criticality represented in terms of C_{eq} and AI is performed on three types (i.e., nil, rectangular, and trapezoidal) of internal membership functions as presented in Figure 4.10 where NRS is nil internal membership function for the RAIRFNET using Salicone's method, NRN is nil internal membership function for the RAIRFNET using neurofuzzy metamodel, RRS is rectangular internal membership function for the RAIRFNET using Salicone's method, RRN is rectangular internal membership function for the RAIRFNET using neurofuzzy metamodel, TRS is trapezoidal internal membership function for the RAIRFNET using Salicone's method, TRN is trapezoidal internal membership function for the RAIRFNET using neurofuzzy metamodel. It can be seen that values of C_{eq} are consistent with values of AI.

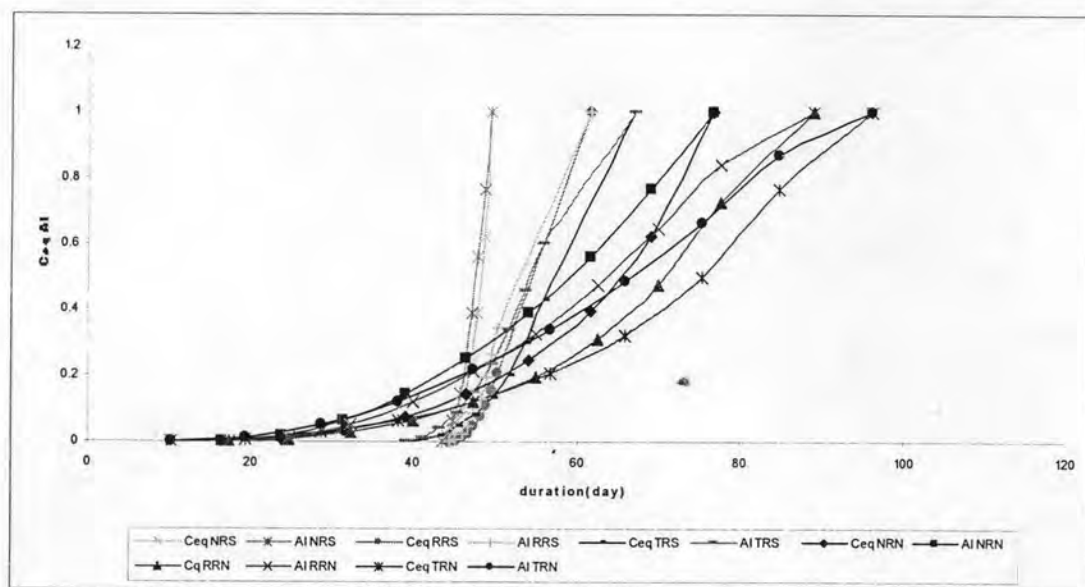

Figure 4.10 C_{eq} and AI for random-fuzzy duration

The comparison between the project completion time calculated by using the FNET based on the fuzzy arithmetic algorithms and the project completion time provided by using the RAIRFNET based on the mathematic for random-fuzzy variables is provided. The cumulative degree of criticality presented in terms of C_{eq} and AI is computed. Three shapes (i.e., nil, rectangular, and trapezoidal) of internal membership functions for fuzzy duration are examined. Figure 4.11 shows the comparison between the cumulative degree of criticality and AI for fuzzy durations and random-fuzzy durations, where NFS is nil internal membership function for the

RAIRFNET using Salicone's method, NFN is nil internal membership function for the RAIRFNET using neurofuzzy metamodel, RFS is rectangular internal membership function for the RAIRFNET using Salicone's method, RFN is rectangular internal membership function for the RAIRFNET using neurofuzzy metamodel, TFS is trapezoidal internal membership function for the RAIRFNET using Salicone's method, TFN is trapezoidal internal membership function for the RAIRFNET using neurofuzzy metamodel.

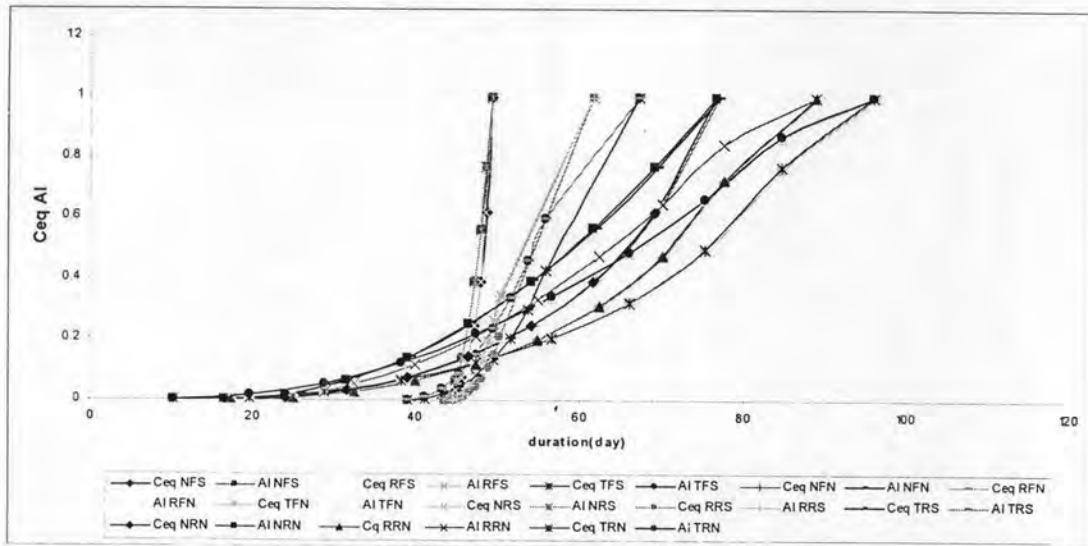

Figure 4.11 C_{eq} and AI for fuzzy and random-fuzzy duration

The results generated by AI and credibility coefficients are presented above. For the same shapes of membership functions of fuzzy and random-fuzzy durations, the fuzzy number based methods provide the wider range of uncertainty than the random-fuzzy number based methods. In general, the random-fuzzy numbers (i.e., duration) are in association with the means and variances of probability distribution functions because the membership functions representing the random part of the random fuzzy variables are transformed from the probability distribution functions. The developed membership function of project duration is accordingly affected by the central limit theorem, which theoretically compensates the random contribution and eliminates the systematic and unknown contributions. The shape of fuzzy project durations calculated using the fuzzy arithmetic algorithms, on the contrary, does not compensate the random contribution and eliminate the systematic and unknown contributions. In addition, the fuzzy and random-fuzzy project durations depend on the selected shapes of internal membership functions of activity duration. Based on

results presented above, the trapezoidal internal membership functions of project durations representing either fuzzy or random–fuzzy numbers provide the widest range of uncertainty, while the nil internal membership functions show the smallest range of uncertainty.

4.3 Comparison among RAIRFNET, Neurofuzzy Metamodel, Probabilistic Results, and Actual Information

This section is to illustrate the comparisons among project durations provided by RAIRFNET, neurofuzzy metamodel, probabilistic method, and actual information. The considered methods are classified into four categories. The comparisons between project completion times obtained from the RAIRFNET using the Salicone's method to develop the membership function of activity duration and the RAIRFNET using the neurofuzzy metamodel to develop the membership function of activity duration belong in the first category.

Different types of probability distribution functions (i.e., triangular, PERT, Pertpg, uniform, normal, Beta distribution) that are found to fit activity duration are used to develop the membership functions. After the membership functions representing aleatory uncertainty due to the random contribution are built, the internal membership functions representing epistemic uncertainty due to the systematic and unknown contribution are established. Shapes of the internal membership function include nil, rectangular, and trapezoidal internal membership functions.

The second category presents the use of a neurofuzzy metamodel and Salicone's method to capture the simulated data associated with project completion times and risk variables. In the data generating process using simulation, the project completion times are calculated from the simulated durations of project activities. Uncertainty due to the random contribution initially represented by a probability distribution is presented in the form of a membership function. To enable the comparison between the first and second categories, the internal membership functions of the project completion times include nil, rectangular, and trapezoidal internal membership functions.

The membership function of project duration is alternatively developed by using the simulation data associated with project completion times derived from different types of probability distributions. Mathematically, the application of these

two methods is different from the use of the Salicone's method and the neurofuzzy metamodel in the RAIRFNET (the first category) because none of network calculation is required for calculating the project completion time. The Salicone's method uses means and the maximum and minimum duration to develop the membership function of project duration. The neurofuzzy metamodel depends mainly on simulation data associated with project completion times used to train the knowledge network. The membership functions are created based on a range of uncertain duration presented by the minimum and maximum values and the means obtained from the simulation.

Project completion times produced by Monte Carlo simulation performed on the selected bored pile construction project is included into the third category, while the actual information of the project completion times is included into the fourth category. The results on 20 runs on 65 units of a bored pile or 1300 cycles of the simulation experiments are provided for developing the probability distribution of the project completion times by using Monte Carlo simulation based on different types of probability distributions. Table 4.14 shows parameters of probability distributions used in the developed simulation model.

To simplify the illustration of the comparison between project completion times represented by the probability distributions and the random-fuzzy numbers within a certain time, the probability of project completion times is calculated in Monte Carlo simulation using CP and in the Salicone's method, the neurofuzzy metamodel and the RAIRFNET (and FNET) method using ΔI and C_{eq} . A number of project durations are computed using these three methods. The comparisons among the results obtained from these three methods are divided into eight categories. Figure 4.12 shows eight comparison categories of results of the proposed methods, simulation and actual information.

For the sake of comparing the simulation results and the actual information with the fuzzy numbers, the frequencies of the activity durations are normalized by dividing them with the maximum frequency. To compare the use of membership function represents every uncertainty and the use of probability distribution, new probability distribution of activity duration is established from parameters which are estimates of the mean and standard deviation of duration calculated from the membership functions having nil, rectangular, and trapezoidal internal membership functions.



Table 4.14 Parameters of probability distributions of advance rate

Distribution	Triangular distribution	Beta distribution	Normal distribution	Exponential distribution	Gamma distribution	Pert	Pertpg	Uniform
Parameters	Minimum= (3.7,3.2,1.3)	Minimum= (3.7,3.2,1.3)	Mean= (3.9,3.5,2.1)	Mean= (3.9,3.5,2.1)	a=(37.8,18.5,2.1)	P_0 =(3.7,3.2,1.3)	P_5 = (3.48,3.00,1.15)	Low= (3.7,3.2,1.3)
	Mode= (3.8,3.3,1.7)	Maximum= (4.3,4.0,3.2)	Standard deviation= (0.32,0.44,1.00)		b=(147.6,64.7,4.4)	Mode=(3.8,3.3,1.7)	Mode= (3.52,3.10,1.50)	High= (4.3,4.0,3.2)
	Maximum= (4.3,4.0,3.2)	a=(0.23,0.29,0.40)				P_{100} =(4.3,4.0,3.2)	P_{95} = (3.56,3.33,3.05)	
		b=(0.46,0.49,0.55)						

Note: values (a, b, c) for ground class (1,2,3)

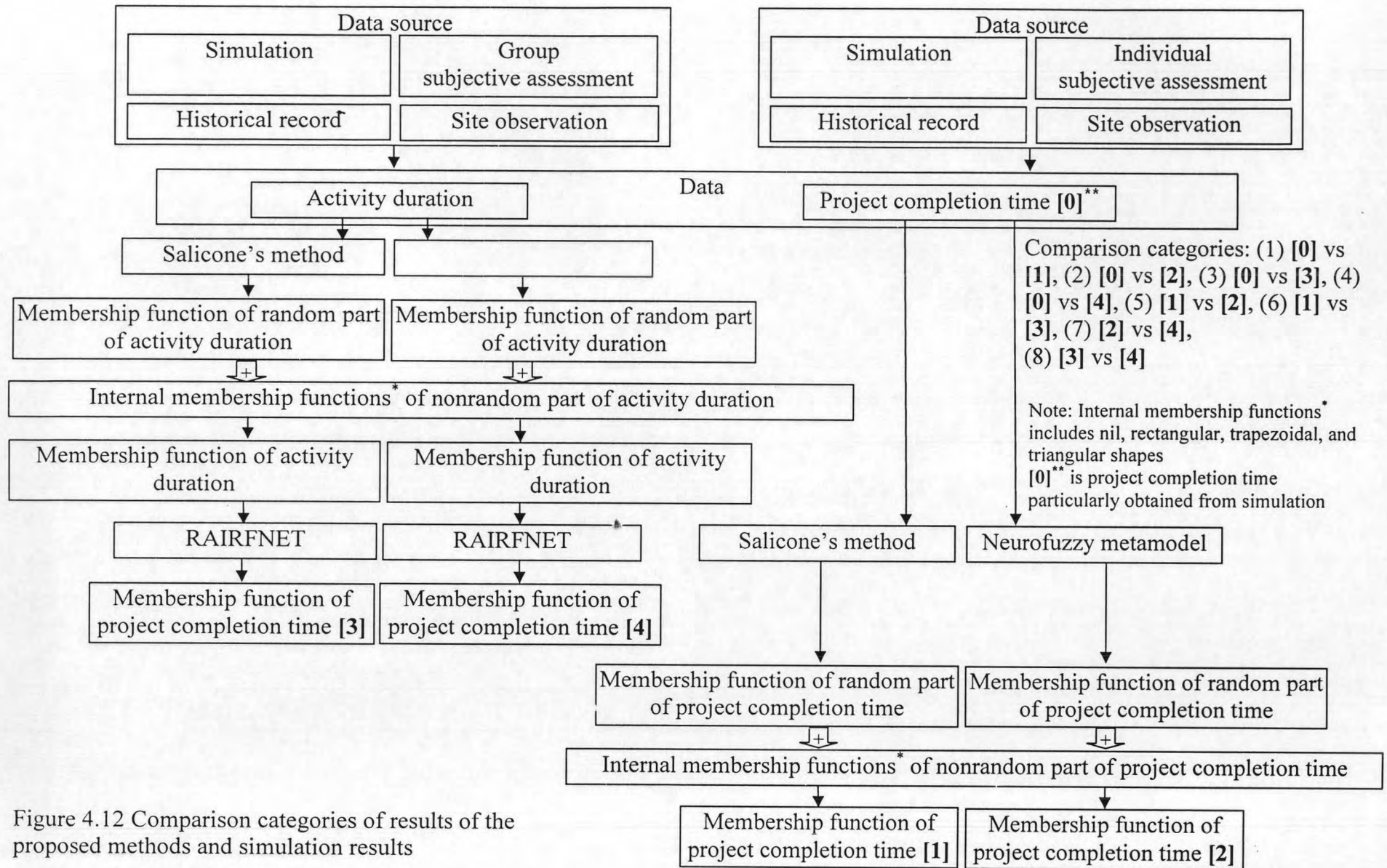

Figure 4.12 Comparison categories of results of the proposed methods and simulation results

4.3.1 Comparison among Project Completion Times Obtained from Simulation, Actual Information and Salicone's Method Processed on Data Associated with Project Completion Times

The results from Monte Carlo simulation on 1300 runs for each of 65 units of a bored pile expressed by means of activity duration on a critical path are obtained. As the statistical simulation outputs are affected by the simulation cycles, a large number of simulation runs is necessary. Table 4.15 presents means of the early start times of four activities for the first and last five units of a bored pile which are provided by simulation. Table 4.16 summarizes the maximum, minimum and average project duration obtained from Monte Carlo simulation for uniform, Pertpg, Pert, Beta, normal, and triangular distributions.

Table 4.15 Early start times for the first and last five units of a bored pile project

Unit	Drilling activity	Cage installation activity	Concrete pouring activity	Soil removal activity
1	0.00	0.61	0.64	0.71
2	0.76	1.38	1.41	1.48
64	47.85	48.49	48.52	48.59
65	48.62	49.24	49.27	49.34

Table 4.16 Maximum, minimum and average project duration for six probabilistic methods

Distribution	Minimum	Mean	Maximum
Uniform	44.7	45.6	46
Pertpg	50.4	51	51
Pert	46.2	47	48
Beta	45.5	46.8	48
Normal	45.4	47	49
Triangular	45.5	46.3	47
Average	44.7	45.6	51

The random-fuzzy project durations obtained using the Salicone's method are represented by three types of internal membership functions (i.e., nil, rectangular, and trapezoidal). Percent deviations of project completion times obtained from the Salicone's method processed on data associated with project completion times and the ones provided by running simulation on the probability distributions that are used to

generate data for the Salicone's method are determined. For example, the random-fuzzy durations obtained from the Salicone's method processed on data drawn based on the normal distribution are determined together with the results provided by the probabilistic method using the normal distribution. The percent deviations of random-fuzzy duration from duration obtained from the probabilistic methods range from -14.97% to -2.11% for the underestimated values where the random-fuzzy duration is smaller than the probabilistic result, and 5.01% to 16.62% for the overestimated values.

The Salicone's method processed on data drawn randomly based on uniform and Pertpg distribution provides the highest and lowest deviation of 16.62% and -14.97%. The results indicate that the random-fuzzy durations provided by the Salicone's method take into account every uncertainty that cannot be examined by the probabilistic method. The difference between random-fuzzy duration and duration obtained from the probabilistic methods depends on the assigned values of epistemic uncertainty due to systematic and unknown contributions. Figure 4.13 depict AI, C_{eq} , and CP values of project completion times calculated by using a normal distribution. It can be seen that the membership functions of project completion times for the nil internal membership function produced by the Salicone's method are close to the corresponding results generated by Monte Carlo simulation. For every type of probability distributions, values of AI and C_{eq} which are calculated by the Salicone's method are smaller than their respective CP values of Monte Carlo simulation. The calculated values of AI and C_{eq} are consistent. The values of AI tend to be larger than the C_{eq} for any project completion time.

Figure 4.14 shows membership functions and probability distributions of duration of project completion time for nil internal membership functions, where TriANSL, TriANSR, TriA, and actual represent left and right parts of membership function obtained from the Salicone's method, triangular probability distribution, and actual information of project completion times, respectively. To compare simulation results obtained from the probability distributions and the actual information with the fuzzy numbers, the frequencies of the activity durations are normalized by dividing them with the maximum frequency.

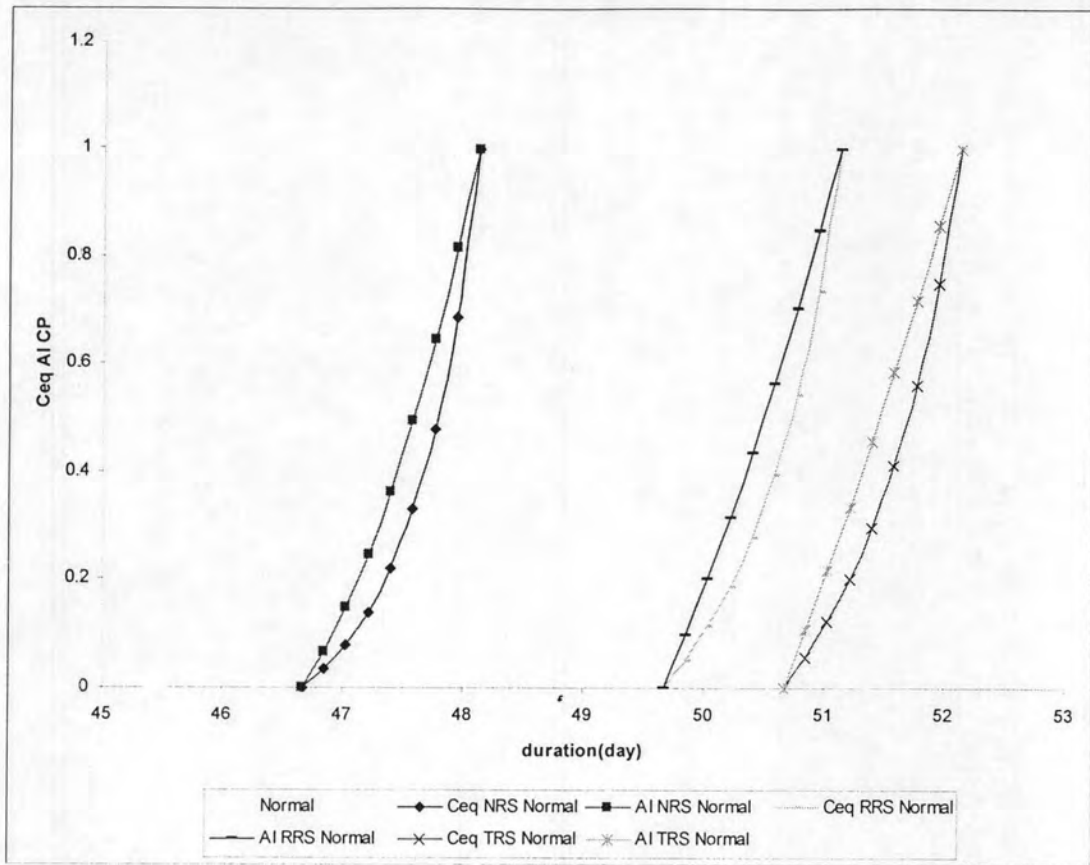

Figure 4.13 CP, AI and C_{eq} for results from the Salicone's method for normal distribution

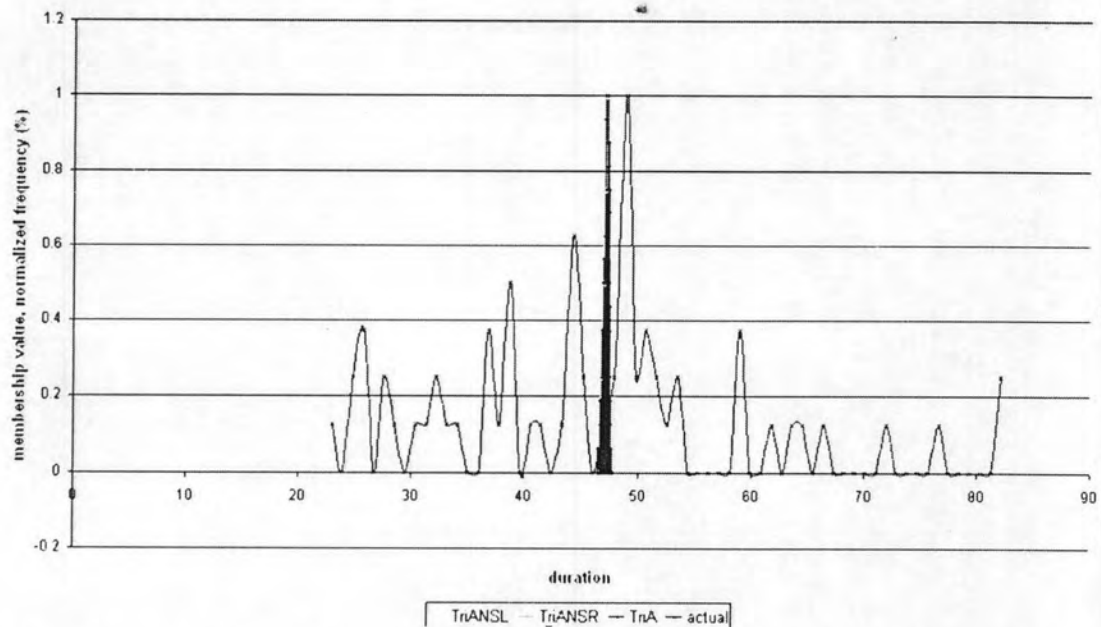

Figure 4.14 Comparison of simulation results for nil internal membership function, actual duration, and triangular distribution – based durations

To consider impact of a particular risk factor or sets of risk factors on activity duration and the project completion time, the evaluation of impact of each risk factor is performed together with the evaluation of impacts of different risk factors combined. The influence of individual and group subjective assessments are shown by estimating the project completion times based on the values of risk variables individually assessed by a project manager, engineer, and foreman and the average one. The impact of shapes of probability distributions on the membership functions representing the random effects is determined by applying different distributions (i.e., triangular, Pert, Pertpg, uniform, normal, Beta distributions) to represent the random variables. The effect of shapes (i.e., nil, rectangular, and trapezoidal) of internal membership function representing the systematic and unknown contributions is considered. To do so, the actual information associated with the project completion times is compared to the project completion times obtained from the proposed method, the Salicone's method processed on data associated with project completion times.

First, results from the group subjective assessment are determined. Results are based on different types of probability distributions used to randomly derive data related to project completion times, where membership functions developed based on data derived from triangular, Pert, Pertpg, uniform, and normal probability distributions are represented by TriANS, Pert, Pertpg, Uni, and Nor, and the left and right parts of membership functions are represented by L and R. Results are presented in association with different sets of risk factors affecting activity duration, where membership functions developed based on data related to sets of risk factors: R_1, R_2, R_3, R_4 and R_5 ; $R_1; R_2; R_3; R_4; R_5$; R_1, R_2, R_3, R_4 ; R_1, R_2, R_3 ; $R_1, R_2; R_2, R_3, R_4, R_5$; R_2, R_3, R_4 ; $R_2, R_3; R_3, R_4, R_5$; R_3, R_4 ; R_4, R_5 are represented by ALL; 1; 2; 3; 4; 5; 1234; 123; 12; 2345; 234; 23; 345; 34; 45, and the left and right parts of membership functions are represented by L and R. For nil internal membership function, results are presented in Figure 4.15 and 4.16. The percent deviations of random-fuzzy duration from actual duration range from -104.63% (uniform distribution for particular risk factors R_1 or R_4) to 0% (triangular distribution for sets of risk factors R_1, R_2, R_3, R_4 and R_3, R_4, R_5) for the underestimated values where the random-fuzzy durations are smaller than the duration based on the actual information, and 1.65% (Pertpg distribution for a risk factor R_2) to 55.35% (Pertpg distribution for a risk factor R_1, R_2, R_3, R_4 and R_5) for the overestimated values. For all risk factors, the

percent deviations of random-fuzzy durations from actual durations range from 2.55% to 13.04% for uniform, triangular, normal, Pert distributions.

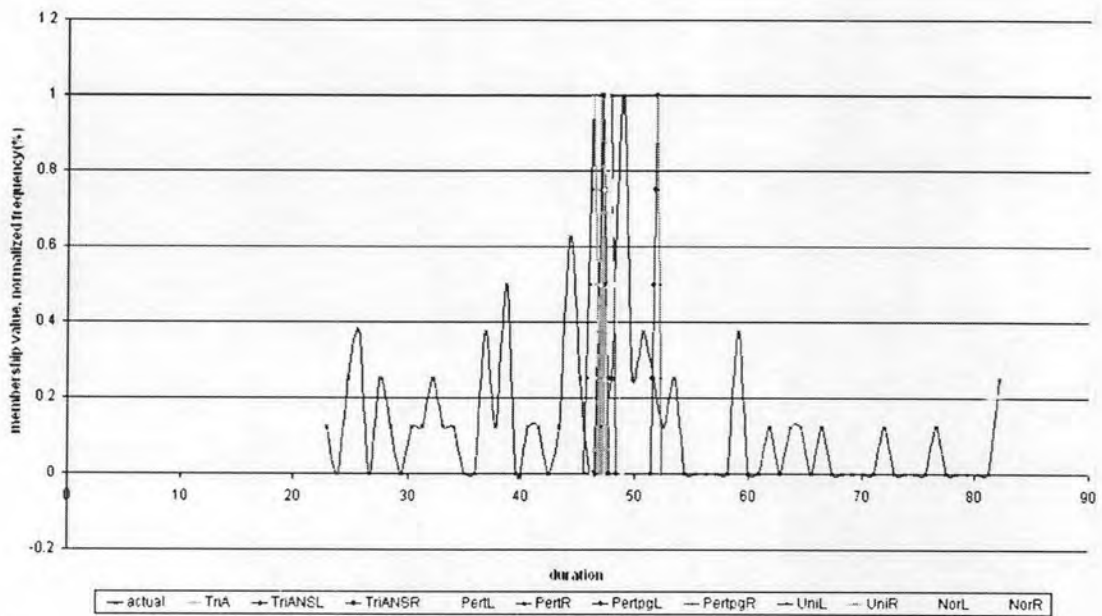

Figure 4.15 Comparison of simulation results for nil internal membership function transformed from different probability distributions of activity duration, actual duration, and triangular distributions – based durations

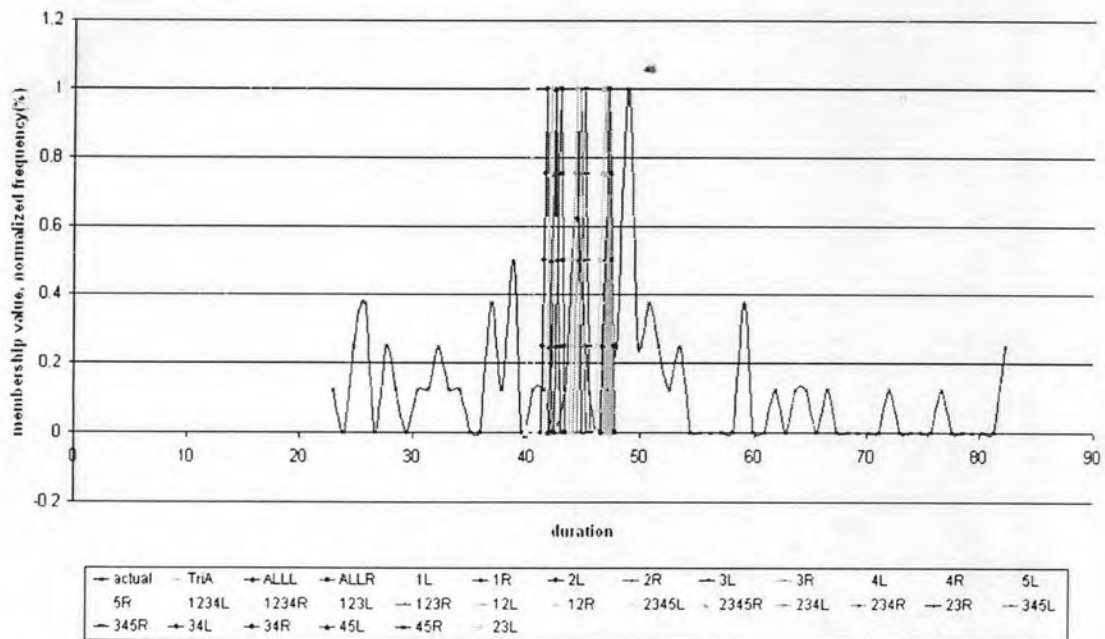

Figure 4.16 Comparison of simulation results for nil internal membership function, actual duration, and triangular distributions – based durations derived from probability distributions related to different sets of risk factors

For rectangular internal membership function, the percent deviations of random-fuzzy duration from actual duration range from -90.40% (uniform distribution for particular risk factors R_1 or R_4) to 0% (triangular distribution for sets of risk factors R_1, R_2, R_3, R_4 and R_1, R_2) for the underestimated values, and 0.47% (Pertpg distribution for a risk factor R_2) to 55.35% (Pertpg distribution for a set of risk factors R_1, R_2, R_3, R_4 and R_5) for the overestimated values. For all risk factors, the percent deviations of random-fuzzy durations from actual durations range from 2.55% to 17.79% for uniform, triangular, normal, Pert distributions.

For trapezoidal internal membership function, the percent deviations of random-fuzzy duration from actual duration range from -81.96% (uniform distribution for particular risk factors R_1 or R_4) to 0% (triangular distribution for sets of risk factors R_1, R_2, R_3 and R_1, R_2) for the underestimated values, and 0.47% (Pertpg distribution for a risk factor R_2) to 53.54% (Pertpg distribution for a set of risk factors R_1, R_2, R_3, R_4 and R_5) for the overestimated values. For all risk factors, the percent deviations of random-fuzzy durations from actual durations range from 2.55% to 11.30% for uniform, triangular, normal, and Pert distributions.

Second, results from the individual subjective assessments are determined. Considering data provided by a project manager, for nil internal membership function, the percent deviations of random-fuzzy duration from actual duration range from -132.82% (uniform distribution for particular risk factors R_1 or R_4) to about -7% (triangular, normal, Pert distributions for a set of risk factors R_1, R_2, R_3, R_4 and R_5) for the underestimated values, and 1.96% (Pertpg distribution for a set of risk factors R_1, R_2, R_3, R_4 and R_5) to 49.19% (Pertpg distribution for a risk factor R_3) for the overestimated values. Examining data provided by an engineer, the percent deviations of random-fuzzy duration from actual duration range from -82.52% (uniform distribution for particular risk factors R_1 or R_4) to -1.65% (triangular distribution for a risk factor R_4) for the underestimated values, and 1.00% (normal distribution for a risk factor R_1) to 60.17% (Pertpg distribution for a risk factor R_3) for the overestimated values. Determining data provided by a foreman, the percent deviations of random-fuzzy duration from actual duration range from -162.37% (uniform distribution for particular risk factors R_1 or R_4) to -11.50% (Pertpg distributions for a set of risk factors R_1, R_2, R_3, R_4 and R_5) for the underestimated values, and 25.49% (normal distribution for a set of risk factors R_1, R_2, R_3, R_4 and R_5) to 42.75% (Pertpg

distribution for a set of risk factors R_1, R_2, R_3, R_4 and R_5) for the overestimated values.

For rectangular internal membership function, the percent deviations of random-fuzzy duration from actual duration range from -116.63% (uniform distribution for particular risk factors R_1 or R_4) to 0% (normal, Pert distributions for sets of risk factors R_1, R_2, R_3, R_4 and R_5) for the underestimated values, and 1.06% (Pertpg distribution for sets of risk factors R_1, R_2, R_3, R_4 and R_5) to 49.19% for Pertpg distribution for sets of risk factor R_1, R_2, R_3, R_4 and R_5) for the overestimated values. Examining data provided by an engineer, the percent deviations of random-fuzzy duration from actual duration range from -69.83% (uniform distribution for particular risk factors R_1 or R_4) to 0% (triangular distribution for a risk factor R_1 or R_4) for the underestimated values, and 1.00% (normal distribution for a risk factor R_1) to 60.17% (Pertpg distribution for sets of risk factor R_1, R_2, R_3, R_4 and R_5) for the overestimated values. Determining data provided by a foreman, the percent deviations of random-fuzzy duration from actual duration range from -144.13% (uniform distribution for particular risk factors R_1 or R_4) to -5.41% (Pertpg distributions for a set of risk factors R_1, R_2, R_3, R_4 and R_5) for the underestimated values, and 25.46% (normal distribution for a set of risk factors R_1, R_2, R_3, R_4 and R_5) to 42.75% (Pertpg distribution for a set of risk factors R_1, R_2, R_3, R_4 and R_5) for the overestimated values.

For trapezoidal internal membership function, the percent deviations of random-fuzzy duration from actual duration range from -107.03% (uniform distribution for particular risk factors R_1 or R_4) to 0% (normal and Pert distributions for a set of risk factors R_1, R_2, R_3, R_4 and R_5) for the underestimated values, and 1.06% (Pertpg distribution for a set of risk factors R_1, R_2, R_3, R_4 and R_5) to 47.13% for Pertpg distribution for a set of risk factors R_1, R_2, R_3, R_4 and R_5) for the overestimated values. Examining data provided by an engineer, the percent deviations of random-fuzzy duration from actual duration range from -62.31% (uniform distribution for particular risk factors R_1 or R_4) to 0% (triangular distribution for particular risk factors R_1 or R_4) for the underestimated values, and 1.00% (normal distribution for a risk factor R_1) to 58.56% (Pertpg distribution for a set of risk factors R_1, R_2, R_3, R_4 and R_5) for the overestimated values. Determining data provided by a foreman, the percent deviations of random-fuzzy duration from actual duration range from -133.31% (uniform distribution for particular risk factors R_1 or R_4) to -5.41% (Pertpg distributions for a set of risk factors R_1, R_2, R_3, R_4 and R_5) for the

underestimated values, and 21.49% (normal distribution for a set of risk factors R_1 , R_2 , R_3 , R_4 and R_5) to 40.42% (Pertpg distribution for a set of risk factors R_1 , R_2 , R_3 , R_4 and R_5) for the overestimated values.

A Monte Carlo simulation is performed so as to estimate the activity duration affected by each risk factor. It can be observed that the normalized frequency of durations of project activities regarding the impact of a particular risk factor is not symmetric. The shape of the obtained normalized frequency cannot be approximated by a normal distribution. A Monte Carlo simulation is also performed in order to estimate the activity duration affected by a set of risk factors. It can be observed that the normalized frequency of durations of project activities regarding the impact of a set of risk factor approximate a trapezoidal distribution which can be an approximation of a normal distribution. Although this research uses different types of probability distributions to represent the temporal variable and risk variables in the simulation model, the obtained final distributions of durations of project activities approximate a normal distribution.

A simulation model is used to estimate the project completion times based on the simulated activity durations. For the sake of presentation, only triangular probability distributions of activity durations are used to estimate the project completion times. Duration of activities including drilling, tremie installation, cage installation, concrete pouring, changing machine position, and soil removal in association with a bored pile construction are captured by the developed simulation model. Six triangular probability distributions of the six activities over different intervals transformed from the corresponding membership functions are considered.

A simulation model provides the symmetric normalized frequency of which means of the distributions of activity duration. The sum of the intervals of activity duration controls the support of the normalized frequency. A trapezoidal distribution can be used to approximate the shape of the normalized frequency approximates. The trapezoidal distribution can be seen as an estimation of a normal distribution. It can be investigated that only a small amount of the results fall at the edges of the summed interval. Thus, the support of the obtained normalized frequency is smaller than the sum of the intervals of activity duration. The expectations of the Central Limit Theorem where the sum of random variables tends to a normal distribution can be confirmed based on the obtained results.

The Salicone's method produces the membership functions of project completion times for the nil internal membership function that are close to the corresponding results generated by Monte Carlo simulation. For the demonstrative application considering the triangular probability distribution, when only random contribution is considered, the range of the project completion times represented by the membership function at α - cut level = 0 which are calculated by the Salicone's method is smaller than the one represented by the probability density function provided by Monte Carlo simulation at the same level of confidence.

When the systematic and unknown contributions are considered together with the random contribution, project completion times are represented by the membership functions having rectangular or trapezoidal internal membership function. The range of the project completion times represented by the membership function at α - cut level = 0 which are calculated by the Salicone's method is larger than the one represented by the probability density function provided by Monte Carlo simulation at the same level of confidence. The assigned values of systematic and unknown contributions control the additional ranges at either lower or upper bound. While the minimum variation of the given confidence interval is associated with the values of the random contribution, the maximum one depends on the assigned values of systematic and unknown contributions. This is a merit of representing duration by the random-fuzzy number that cannot be obtained from representing it by the probability distribution because the random-fuzzy number suitably represents values of the temporal variable together with its uncertainty in every situation based on available information, obtained either experimentally or from a priori knowledge.

4.3.2 Comparison between Project Completion Times Obtained from Simulation, Actual Information and Neurofuzzy Metamodel Trained on Data Associated with Project Completion Times

The results from Monte Carlo simulation expressed in terms of maximum, minimum and average project duration are used to compare with the results provided by neurofuzzy metamodel trained on the simulated data associated with project completion times.

The neurofuzzy metamodels provide results represented by three types of internal membership functions (i.e., nil, rectangular, and trapezoidal). The percent deviations of the random-fuzzy mode from probabilistic mean, the optimistic duration

from minimum duration and the pessimistic duration from maximum duration for particular distributions are determined. The percent deviations of project completion times obtained from the neurofuzzy metamodel and the ones provided by running simulation on the probability distributions are determined. The percent deviations of random-fuzzy duration from duration obtained from the probabilistic methods range from -25.91% to -1.09% for the underestimated values where the random-fuzzy duration is smaller than the probabilistic result, and 0.24% to 21.95% for the overestimated values. The neurofuzzy metamodels trained on data drawn randomly based on Beta and Pertpg distribution provide the highest and lowest deviation of 21.95% and -25.91%. The results show that the neurofuzzy metamodel provides the random-fuzzy durations that are able to explain every uncertainty which cannot be fully determined by the probabilistic method. The difference depends on the assigned values of epistemic uncertainty due to systematic and unknown contributions.

The values of CP of project durations calculated by the six methods and particularly the method using a normal distribution, AI and C_{eq} are determined. Results obtained from the one using the normal distribution are presented in Figure 4.17. It can be investigated that the membership functions of project completion times for any type of the internal membership function produced by the neurofuzzy metamodel behave in a similar way towards the corresponding results generated by Monte Carlo simulation. A wider range for the project duration associated with the neurofuzzy metamodel can be observed. For every type of distributions, values of AI and C_{eq} which are calculated by the neurofuzzy metamodel tend to be larger than their respective values of CP of Monte Carlo simulation when the project durations are smaller than the calculated means and otherwise beyond the means. Although values of AI and C_{eq} values are consistent, the former tends to be larger than the later for any project duration.

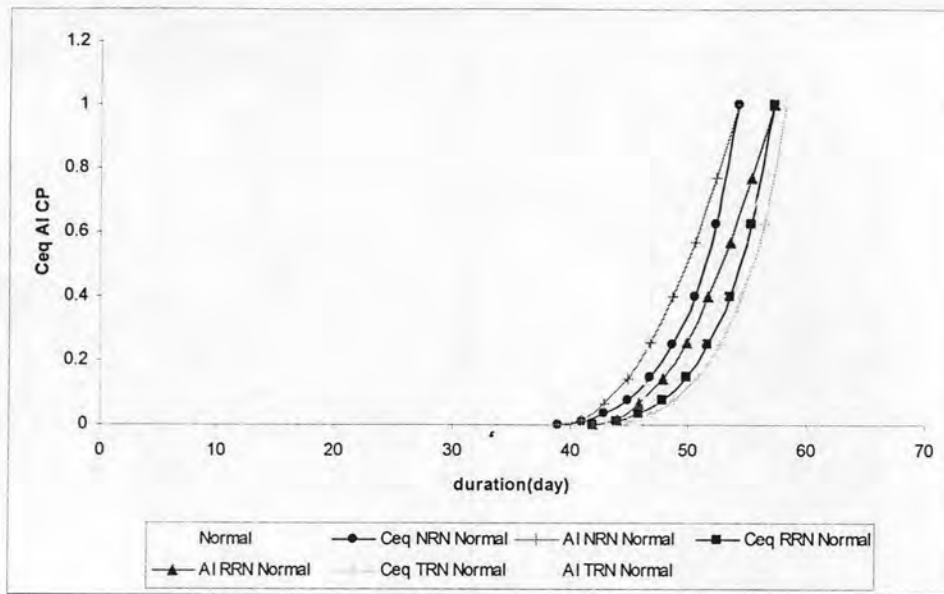

Figure 4.17 CP, AI and C_{eq} for results from the neurofuzzy metamodel for normal distribution

Figure 4.18 shows membership functions and probability distributions of duration of project completion time for nil internal membership functions, where TriANNL, TriANNR, TriA, and actual represent left and right parts of membership function obtained from the neurofuzzy metamodel, triangular probability distribution, and actual information of project completion times, respectively. To compare simulation results obtained from the probability distributions and the actual information with the fuzzy numbers, the frequencies of the project completion times are normalized by dividing them with the maximum frequency. The development of the normalized frequency of simulated project duration is discussed in the previous section.

Impact of a particular risk factor or sets of risk factors on activity duration and the project completion time is considered. The impact of each risk factor together with the impacts of different risk factors combined is evaluated. The demonstration of effects of individual and group subjective assessments is provided. The project completion times are estimated based on the values of risk variables individually assessed by a project manager, engineer, and foreman and the average one. Different shapes of probability distributions on the membership functions representing the random effects are determined. In this research, the triangular, Pert, Pertpg, uniform, normal, Beta distributions are used to represent the random variables. Different

shapes (i.e., nil, rectangular, and trapezoidal) of internal membership function representing the systematic and unknown contributions are considered. The actual information associated with the project completion times is compared to the project completion times obtained from the proposed method, the neurofuzzy metamodel trained on data associated with project completion times.

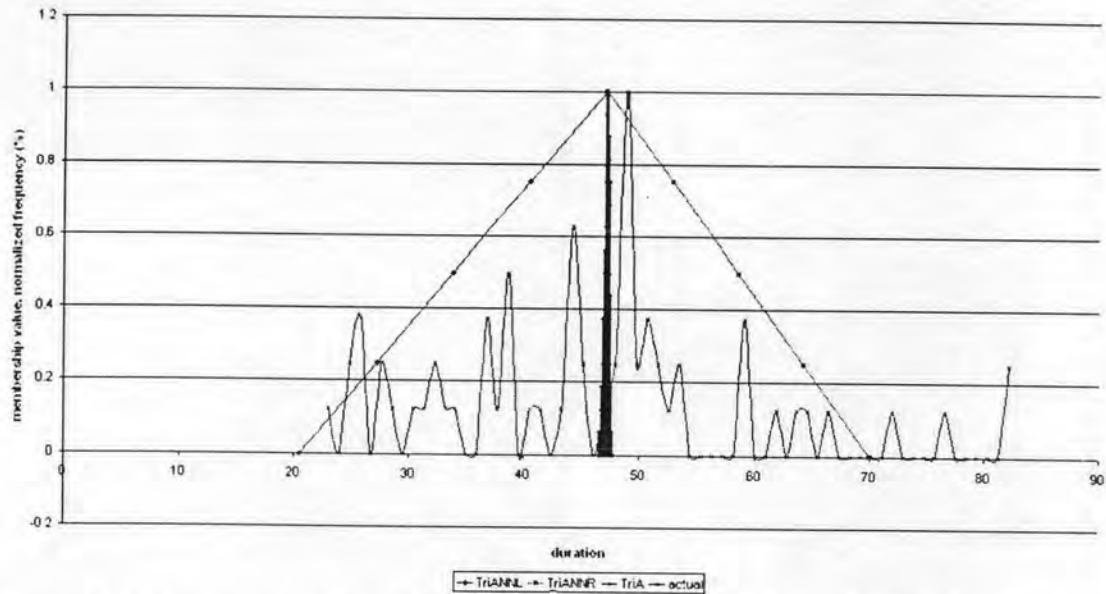

Figure 4.18 Comparison of simulation results for nil internal membership function, actual duration, and triangular distribution – based durations

First, results from the group subjective assessment are as shown in Figure 4.19 to 4.20 for nil internal membership functions. Data are related to different types of probability distributions used to randomly derive data related to project completion times, where membership functions developed based on data derived from triangular, Pert, Pertpg, uniform, and normal probability distributions are represented by TriANS, Pert, Pertpg, Uni, and Nor, and the left and right parts of membership functions are represented by L and R. Results are presented in association with different sets of risk factors affecting activity duration, where membership functions developed based on data related to sets of risk factors: R_1, R_2, R_3, R_4 and R_5 ; $R_1; R_2; R_3; R_4; R_5$; $R_1, R_2, R_3, R_4; R_1, R_2, R_3; R_1, R_2; R_2, R_3, R_4, R_5; R_2, R_3, R_4; R_2, R_3; R_3, R_4, R_5; R_3, R_4; R_4, R_5$ are represented by ALL; 1; 2; 3; 4; 5; 1234; 123; 12; 2345; 234; 23; 345; 34; 45, and the left and right parts of membership functions are represented by L and R. The percent deviations of random-fuzzy duration from actual duration range from -725.96% (uniform distribution for a risk factor R_5) to 0% (triangular

distribution for a set of risk factors R_1, R_2, R_3, R_4) for the underestimated values where the random-fuzzy durations are smaller than the duration based on the actual information, and 1.64% (Pertpg distribution for a risk factor R_2) to 68.15% (uniform distribution for a risk factor R_2) for the overestimated values.

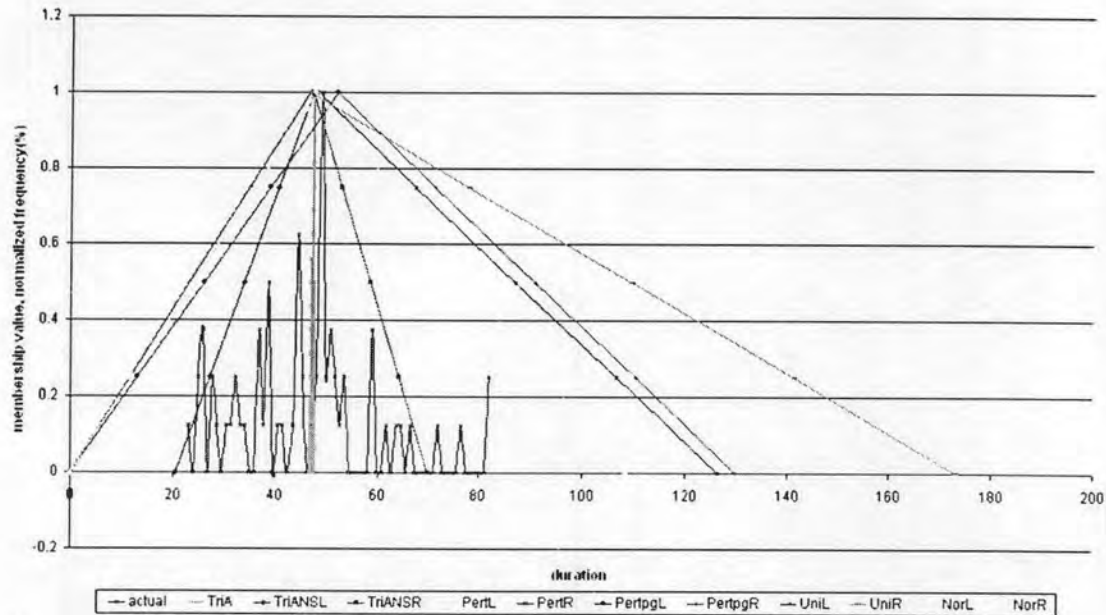

Figure 4.19 Comparison of simulation results for nil internal membership function transformed from different probability distributions of activity duration, actual duration, and triangular distributions – based durations

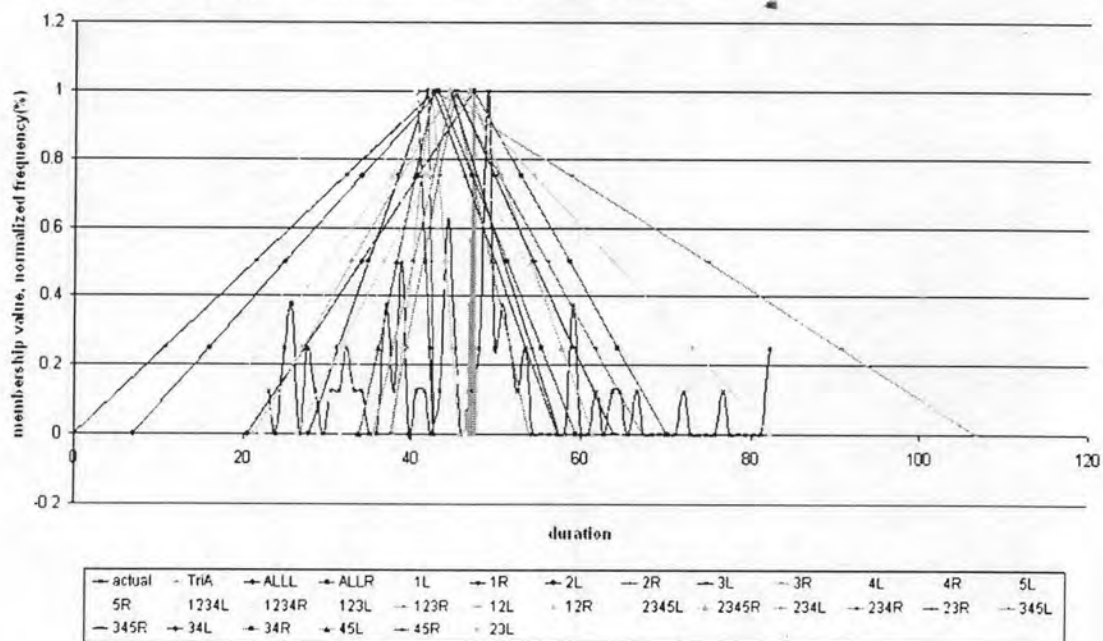

Figure 4.20 Comparison of simulation results for nil internal membership function, actual duration, and triangular distributions – based durations derived from probability distributions related to different sets of risk factors

For rectangular internal membership function, the percent deviations of random-fuzzy duration from actual duration range from -725.96% (uniform distribution for a particular risk factor R_5) to 0% (Pert distribution for a risk factor R_2) for the underestimated values, and 1.24% (Pert distribution for a risk factor R_5) to 68.52% (uniform distribution for a particular risk factor R_2) for the overestimated values.

For trapezoidal internal membership function, the percent deviations of random-fuzzy duration from actual duration range from -2839.94% (uniform distribution for a particular risk factor R_5) to 0% (Pert distribution for a risk factor R_2) for the underestimated values, and 1.24% (Pert distribution for a risk factor R_5) to 1248.68% (uniform distribution for a particular risk factor R_2) for the overestimated values.

Results from the individual subjective assessments are considered.

Determining data provided by a project manager, for nil internal membership function, the percent deviations of random-fuzzy duration from actual duration range from -839.76% (uniform distribution for a risk factor R_5) to 0% (uniform distribution for a risk factor R_3) for the underestimated values, and 1.05% (Pertpg distribution for a set of risk factors R_1, R_2, R_3, R_4 and R_5) to 63.76% (uniform distribution for a risk factor R_2) for the overestimated values. Examining data provided by an engineer, the percent deviations of random-fuzzy duration from actual duration range from -636.74% (uniform distribution for a risk factor R_5) to 0% (normal distribution for a risk factor R_2) for the underestimated values, and 1.05% (triangular distribution for a risk factor R_4) to 71.59% (uniform distribution for a risk factor R_2) for the overestimated values. Considering data provided by a foreman, the percent deviations of random-fuzzy duration from actual duration range from -959.06% (uniform distribution for a risk factor R_5) to -1.65% (triangular distribution for a risk factor R_1) for the underestimated values, and 1.05% (triangular distribution for a risk factor R_4) to 59.16% (uniform distribution for a risk factor R_2) for the overestimated values.

For the rectangular internal membership function, the percent deviations of random-fuzzy duration from actual duration range from -839.77% (uniform distribution for a particular risk factor R_5) to 0% (normal distribution for a risk factor R_1) for the underestimated values, and 1.06% (Pert distribution for a set of risk factors R_1, R_2, R_3, R_4 and R_5) to 64.18% (uniform distribution for a particular risk factor R_2) for the overestimated values. Examining data provided by an engineer, the percent

deviations of random–fuzzy duration from actual duration range from -636.74% (uniform distribution for a risk factor R_5) to 0% (triangular distribution for a set of risk factors R_1, R_2, R_3, R_4 and R_5) for the underestimated values, and 1.05% (triangular distribution for a risk factor R_4) to 71.91% (uniform distribution for a risk factor R_2) for the overestimated values. Considering data provided by a foreman, the percent deviations of random–fuzzy duration from actual duration range from -959.06% (uniform distribution for a risk factor R_5) to -1.64% (triangular distribution for a risk factor R_1) for the underestimated values, and 2.01% (pert distribution for a risk factor R_5) to 59.63% (uniform distribution for a risk factor R_2) for the overestimated values.

For results related to the trapezoidal internal membership function, the percent deviations of random–fuzzy duration from actual duration range from -3245.02% (uniform distribution for a particular risk factor R_5) to 0% (Pert distribution for a set of risk factors R_1, R_2, R_3, R_4 and R_5) for the underestimated values, and 1.05% (Pertpg distribution for a set of risk factors R_1, R_2, R_3, R_4 and R_5) to 1406.95% (uniform distribution for a particular risk factor R_2) for the overestimated values. Examining data provided by an engineer, the percent deviations of random–fuzzy duration from actual duration range from -2522.37% (uniform distribution for a risk factor R_5) to -1.42% (triangular distribution for a set of risk factors R_1, R_2, R_3) for the underestimated values, and 1.05% (triangular distribution for a risk factor R_4) to 1124.60% (uniform distribution for a risk factor R_2) for the overestimated values. Considering data provided by a foreman, the percent deviations of random–fuzzy duration from actual duration range from -3669.64% (uniform distribution for a risk factor R_5) to -2.46% (Pert distribution for a risk factor R_4) for the underestimated values, and 0 % (triangular distribution for a risk factor R_5) to 1572.86% (uniform distribution for a risk factor R_2) for the overestimated values.

The membership functions of project completion times provided by the neurofuzzy metamodel for the nil internal membership function are close to the corresponding results generated by Monte Carlo simulation as both of them consider only the random effect. The illustrative application considering the triangular probability distribution is provided to simplify the presentation. It can be seen from the figure that when only random contribution is considered, the range of the project completion times represented by the membership function at α – cut level = 0 which are calculated by the neurofuzzy metamodel is larger than the one represented by the

probability density function provided by Monte Carlo simulation at the same level of confidence.

For the membership functions having rectangular or trapezoidal internal membership function, the range of the project completion times represented by the membership function at α – cut level = 0 which are calculated by the neurofuzzy metamodel is larger than the one represented by the probability density function provided by Monte Carlo simulation at the same level of confidence. The additional ranges at either lower or upper bound depend on the assigned values of systematic and unknown contributions. The values of the random contribution control the minimum variation of the given confidence interval, while the assigned values of systematic and unknown contributions control the maximum one.

4.3.3 Comparison between Project Durations Obtained from RAIRFNET Using Salicone's Method and Simulation

Simulation results shown in Table 4.15 and 4.16 are used to compare with the results provided by RAIRFNET using Salicone's method to provide the membership functions of activity duration for the network calculation. The RAIRFNET provides the project completion times presented by three shapes of internal membership functions (i.e., nil, rectangular, and trapezoidal). The shapes are designed based on the assigned values of uncertainty due to the systematic and unknown contributions. For different α – cut levels (i.e., 0, 0.25, 0.5, 0.75, and 1), the percent deviations of the random-fuzzy modes from probabilistic means, the optimistic durations from minimum durations and the pessimistic durations from maximum durations derived from a triangular distribution are computed.

The percent deviations ranges from -23.19% to -11.79% for the underestimated values where the random-fuzzy duration is smaller than the probabilistic result, and 2.02% to 47.82% for the overestimated values. The highest and lowest deviations of 47.82% and -23.19% are obtained from the method having the rectangular internal membership function, at the level $\alpha = 0$, respectively. The comparing results indicate that the random-fuzzy durations can explain every uncertainty that cannot be determined by the probabilistic methods. The difference between random-fuzzy duration and duration obtained from the probabilistic methods depends on the assigned values of epistemic uncertainty due to systematic and

unknown contributions. In addition, the mathematics for random–fuzzy variables increase such difference.

Working durations (i.e., minimum and maximum duration) for each unit of a bored pile are depicted in Figure 4.21. The RAIRFNET using trapezoidal and rectangular internal membership functions provides the wider range of project completion times than the one using nil internal membership function because every uncertainty is considered in the network calculation. The results also confirm that the RAIRFNET using the nil internal membership function produces the project completion time closer to the one provided by simulation as both of them determine only uncertainty due to the random contribution.

Figure 4.22 shows the values of CP of project completion times examined at five α -cut levels, AI and C_{eq} particularly for duration derived from the triangular distribution. It can be observed that the membership functions of project completion times for any shape of the internal membership function produced by RAIRFNET using the Salicone's method represent the uncertainty in a similar way. The membership function of project completion times can be predetermined as it depends on those of the membership functions of activity duration. As expected, values of AI and values of C_{eq} obtained from the RAIRFNET using nil internal membership functions is found to be the nearest to values of CP given by Monte Carlo simulation because only the random contribution. It also shows that the assigned values of epistemic uncertainty due to the systematic and unknown contributions have a significant impact on the obtained values of AI and C_{eq} , but CP.

Figure 4.23 shows membership functions and probability distributions of duration of project completion time for nil internal membership functions, where RTriANSL, RTriANSR, TriA, and actual represent left and right parts of membership function obtained from the Salicone's method, triangular probability distribution, and actual information of project completion times, respectively. To compare simulation results obtained from the probability distributions and the actual information with the fuzzy numbers, the frequencies of the project completion times are normalized by dividing them with the maximum frequency. The establishment of the probability distribution of the simulated project completion time is discussed in the previous section.

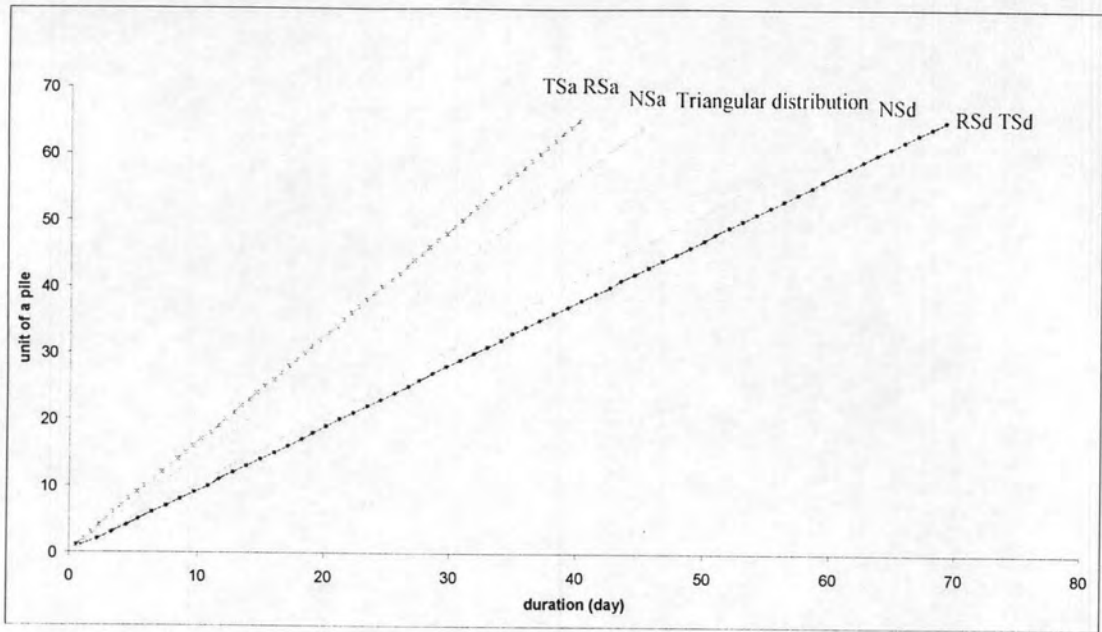

Figure 4.21 Working duration for each unit of a bored pile obtained from RAIRFNET based Salicone's method and simulation for nil, rectangular, and trapezoidal internal membership functions of random-fuzzy duration

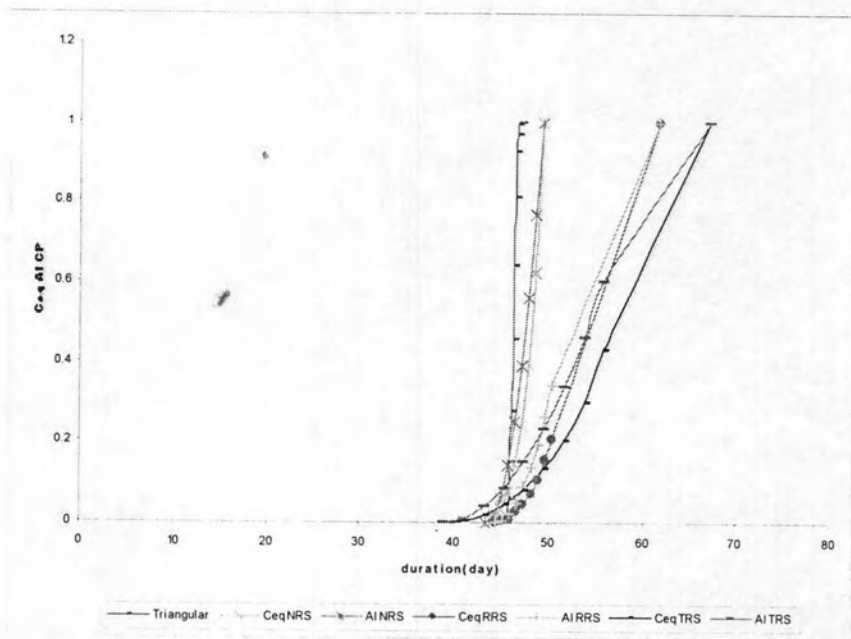

Figure 4.22 CP, AI and C_{eq} for results from RAIRFNET using Salicone's method processed on activity duration data

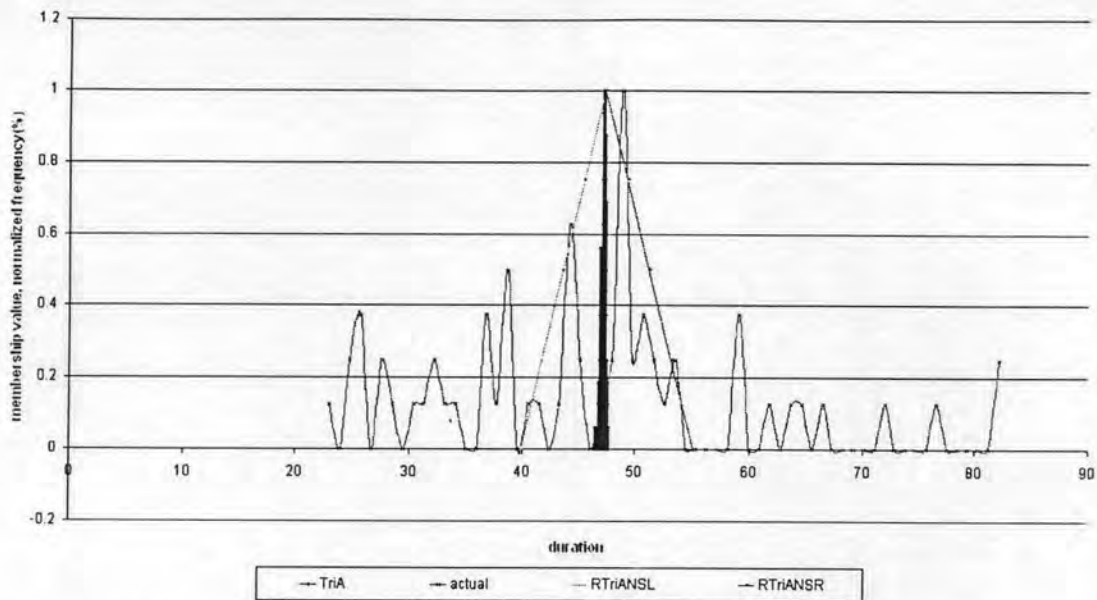

Figure 4.23 Comparison of simulation results for nil internal membership function, actual duration, and triangular distribution – based durations

To determine impact of a particular risk factor or sets of risk factors on activity duration and the project completion time, the impacts of each risk factor or risk factors combined are evaluated. The effects of individual and group subjective assessments are also assessed by estimating the project completion times based on the values of risk variables individually assessed by a project manager, engineer, and foreman and the average one. The influence of shapes of probability distributions on the membership functions representing the random effects is determined by applying different distributions (i.e., triangular, Pert, Pertpg, uniform, normal, Beta distributions) to represent the random variables. The impact of shapes (i.e., nil, rectangular, and trapezoidal) of internal membership function representing the systematic and unknown contributions is considered. The results are compared with the actual information associated with the project completion times.

First, results from the group subjective assessment, for nil internal membership function, are as shown in Figure 4.24 to 4.25 based on different types of probability distributions used to randomly derive data related to project completion times, where membership functions developed based on data derived from triangular, Pert, Pertpg, uniform, and normal probability distributions are represented by TriANS, Pert, Pertpg, Uni, and Nor, and the left and right parts of membership functions are represented by L and R. Results are in association with different sets of risk factors affecting activity duration, where membership functions developed based

on data related to sets of risk factors: R_1, R_2, R_3, R_4 and R_5 ; R_1, R_2, R_3, R_4, R_5 ; R_1, R_2, R_3, R_4 ; R_1, R_2, R_3 ; $R_1, R_2, R_2, R_3, R_4, R_5$; R_2, R_3, R_4 ; R_2, R_3 ; R_3, R_4, R_5 ; R_3, R_4 ; R_4, R_5 are represented by ALL; 1; 2; 3; 4; 5; 1234; 123; 12; 2345; 234; 23; 345; 34; 45, and the left and right parts of membership functions are represented by L and R., the percent deviations of random-fuzzy duration from actual duration range from -66.30% (uniform distribution for particular risk factors R_1 or R_4) to 0% (Pertpg distribution for a risk factor R_1) for the underestimated values, and 3.08% (uniform distribution for a set of risk factors R_1, R_2, R_3, R_4 and R_5) to 46.95% (Pertpg distribution for a risk factor R_3) for the overestimated values.

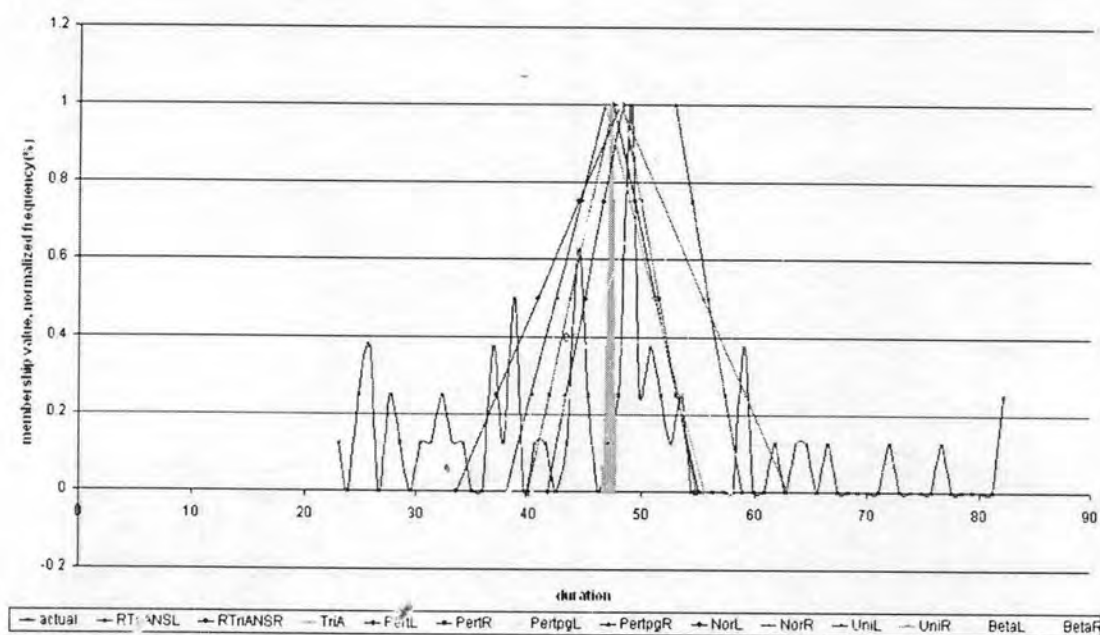

Figure 4.24 Comparison of simulation results for nil internal membership function transformed from different probability distributions of activity duration, actual duration, and triangular distributions – based durations

For rectangular internal membership function, the percent deviations of random-fuzzy duration from actual duration range from -33.21% (triangular distribution for a set of risk factors R_3 and R_4) to 0% (triangular distribution for a set of risk factors R_2, R_3) for the underestimated values, and 1.15% (triangular distribution for a set of risk factors R_1, R_2, R_3) to 48.12% (Pertpg distribution for a risk factor R_3) for the overestimated values.

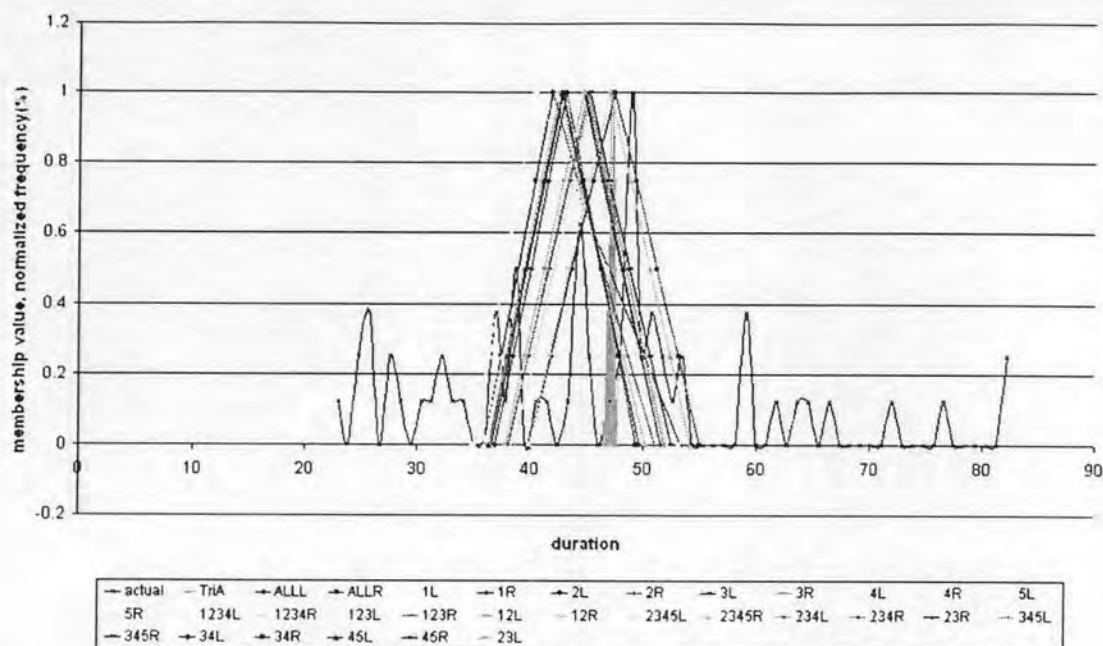

Figure 4.25 Comparison of simulation results for nil internal membership function, actual duration, and triangular distributions – based durations derived from probability distributions related to different sets of risk factors

For trapezoidal internal membership function, the percent deviations of random-fuzzy duration from actual duration range from -1729.69% (Pert distribution for a particular risk factor R_3) to 0% (triangular distribution for a set of risk factors R_2, R_3) for the underestimate values, and 1.15% (triangular distribution for a set of risk factors R_1, R_2, R_3) to 51.21% (Pert distribution for a risk factor R_3) for the overestimated values.

Second, results from the individual subjective assessments are determined. Considering data provided by a project manager, for nil internal membership function, the percent deviations of random-fuzzy duration from actual duration range from -47.01% (triangular distribution for a set of risk factors R_3 and R_4) to 0% (uniform distribution for a risk factor R_4) for the underestimated values, and 1.69% (normal distribution for a risk factor R_1) to 53.02% (Pertpg distribution for a risk factor R_3) for the overestimated values. Examining data provided by an engineer, the percent deviations of random-fuzzy duration from actual duration range from -34.7% (triangular distribution for a set of risk factors R_3 and R_4) to -5.70% (normal distribution for a set of risk factors R_1, R_2, R_3, R_4, R_5) for the underestimated values, and 7.55% (uniform distribution for a risk factor R_1) to 56.90% (Pertpg distribution for a risk factor R_3) for the overestimated values. Determining data provided by a

foreman, the percent deviations of random-fuzzy duration from actual duration range from -80.04% (triangular distribution for a set of risk factors R_3 and R_4) to -1.42% (Pert distributions for a set of risk factors R_1, R_2, R_3, R_4 and R_5) for the underestimated values, and 7.56% (Pertpg distribution for a set of risk factors R_1, R_2, R_3, R_4 and R_5) to 42.78% (Pertpg distribution for a risk factor R_3) for the overestimated values.

For results related to rectangular internal membership function, for data provided by a project manager the percent deviations of random-fuzzy duration from actual duration range from -29.33% (triangular distribution for a set of risk factors R_3 and R_4) to 0% (uniform distribution for a risk factor R_4) for the underestimated values, and 2.07% (triangular distribution for a risk factor R_4) to 53.62% (Pert distribution for a risk factor R_3) for the overestimated values. Examining data provided by an engineer, the percent deviations of random-fuzzy duration from actual duration range from -7.73% (triangular distribution for a set of risk factors R_3 and R_4) to 0% (triangular distribution for a set of risk factors R_2, R_3, R_4 and R_5) for the underestimated values, and 1.30% (Pert distribution for a set of risk factors R_1, R_2, R_3, R_4 and R_5) to 57.91% (Pertpg distribution for a risk factor R_3) for the overestimated values. Determining data provided by a foreman, the percent deviations of random-fuzzy duration from actual duration range from -65.72% (triangular distribution for a set of risk factors R_3 and R_4) to -0.67% (Pert distributions for a set of risk factors R_1, R_2, R_3, R_4 and R_5) for the underestimated values, and 0.38% (triangular distribution for a set of risk factors R_2 and R_3) to 42.75% (Pertpg distribution for a set of risk factors R_1, R_2, R_3, R_4 and R_5) for the overestimated values.

For trapezoidal internal membership function, results are presented. For data provided by a project manager, the percent deviations of random-fuzzy duration from actual duration range from -1557.37% (pert distribution for a particular risk factor R_3) to 0% (uniform distributions for a risk factor R_1) for the underestimated values, and 2.07% (uniform distributions for a risk factor R_4) to 49.47% for Pert distribution for a risk factor R_3) for the overestimated values. Examining data provided by an engineer, the percent deviation of random-fuzzy duration from actual duration is -2121% (pert distribution for a particular risk factor R_3) for the underestimated values, and 7.17% (triangular distribution for a set of risk factors R_3 and R_4) to 56.97% (Pert distribution for a risk factor R_3) for the overestimated values. Determining data provided by a foreman, the percent deviations of random-fuzzy duration from actual duration range

from -1258.36% (Pert distribution for a particular risk factor R_3) to 0% (triangular distribution for a set of risk factors R_2 and R_3) for the underestimated values, and 1.16% (normal distribution for a risk factor R_4) to 45.42% (Pert distribution for a risk factor R_3) for the overestimated values.

The Salicone's method produces the nil membership functions of activity duration that are close to the corresponding results generated by Monte Carlo simulation. To simplify the presentation, information in association with the triangular probability distribution is considered. When only random contribution is determined, the range of the activity duration represented by the membership function at α - cut level = 0 which are calculated by the Salicone's method is smaller than the one represented by the probability density function provided by Monte Carlo simulation at the same level of confidence. On the contrary, the range of the project completion times represented by the membership function at α - cut level = 0 which are calculated based on the mathematics for the random-fuzzy variables is larger than the ones provided by Monte Carlo simulation at the same level of confidence.

To consider the systematic and unknown contributions together with the random contribution, activity duration and project completion times are represented by the membership functions having rectangular or trapezoidal internal membership function. The range of the project completion times represented by the membership function at α - cut level = 0 provided by RAIRFNET using the Salicone's method is larger than the one represented by the probability density function provided by Monte Carlo simulation at the same level of confidence. The extended range at either lower or upper bound depend on the assigned values of systematic and unknown contributions. While the values of the random contribution provide the minimum variation of the given confidence interval, the maximum one is based on the assigned values of systematic and unknown contributions.

To compare the probability distribution function and membership function developed by considering every uncertainty, the probability of occurrence for each element of the project completion times represented by the membership function is computed. The values for the mean and the standard deviations of the project completion times are determined. The statistical form of frequency of project completion times is used to approximate the probability density function of the project completion times. In this research, simulation is used to generate data related to

activity duration based on the parameters of the durations of project activities which are estimates of the mean and standard deviation of duration calculated from the membership functions having nil, rectangular, and trapezoidal internal membership functions. The project completion times are consequently computed based on the simulated activity duration.

To simplify the presentation, only triangular probability distribution functions of activity duration are used to estimate the project completion times. For activities (i.e., drilling, tremie installation, cage installation, concrete pouring, changing machine position, and soil removal) in association with a bored pile construction captured by the developed simulation model, six triangular probability distribution functions over different intervals transformed from the corresponding membership functions are considered. Figure 4.26 to 4.28 present the comparison of simulation results or the normalized frequency of the project completion times obtained by applying the Monte Carlo simulation based on distributions transformed from the nil, rectangular, and trapezoidal internal membership functions obtained from the Salicone's method and triangular distribution based durations for a set of risk factors $R_1, R_2, R_3, R_4,$ and R_5 . A number of random extractions have been considered for each distribution and then summed up to estimate the project completion time. The obtained normalized frequency or histogram is symmetric and its mean is the sum of the means of the distributions of durations of project activities. The support of the normalized frequency is interval, in association with the sum of the intervals of activity duration. The shape of the normalized frequency approximates a trapezoidal distribution which can be seen as rough estimation of a normal distribution. From Figure 4.26 to 4.28, where $R_{TriANSL}$, $R_{TriANSR}$, $R_{TriANNL}$, Tri , $TriA$, and actual represent left and right parts of membership function obtained from the Salicone's method, triangular probability distribution, and actual information of project completion times, the support of the obtained normalized frequency seems to be a bit smaller than the sum of the intervals of activity duration. In the other words, only a small amount of the results fall at the edges of the summed interval. The obtained results show how the Monte Carlo simulations confirm the expectations of the Central Limit Theorem where the sum of random variables tends to a normal distribution.

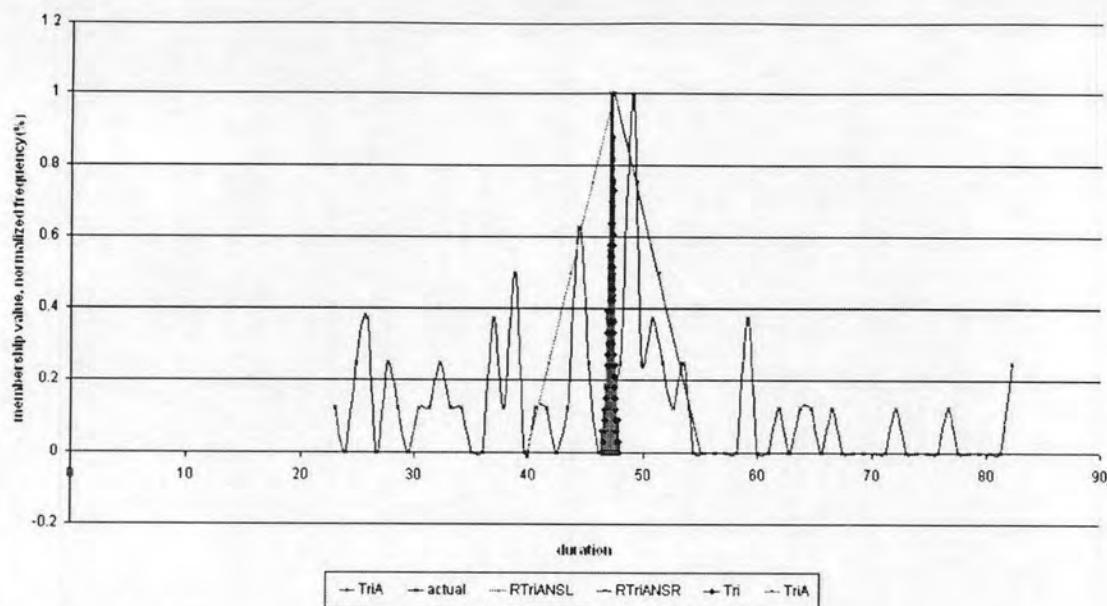

Figure 4.26 Comparison of simulation results for nil internal membership function, actual duration, and triangular distributions – based durations derived from initial and transformed probability distributions of activity duration

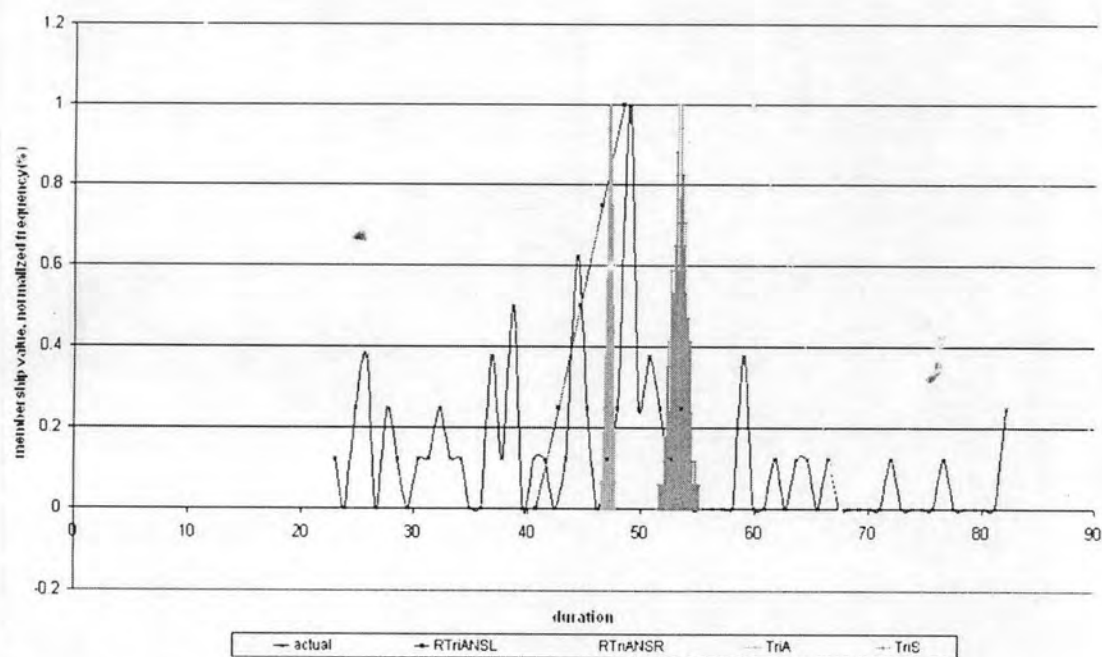

Figure 4.27 Comparison of simulation results for rectangular internal membership function, actual duration, and triangular distribution – based durations derived from initial and transformed probability distributions of activity duration

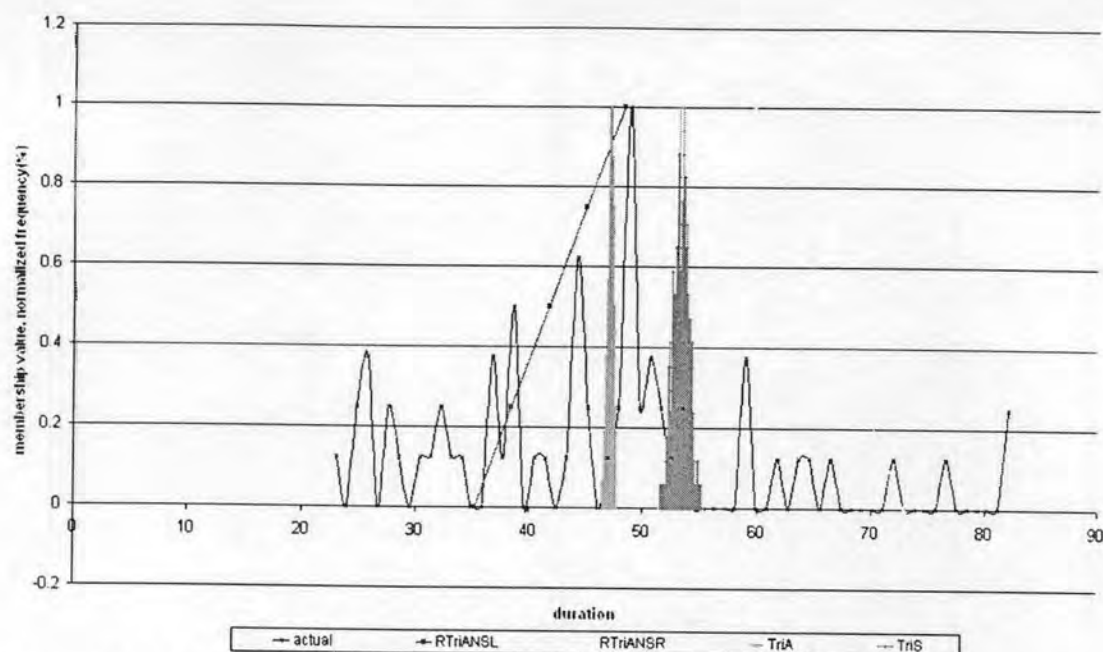

Figure 4.28 Comparison of simulation results for trapezoidal internal membership function, actual duration, and triangular distribution – based durations derived from initial and transformed probability distributions of activity duration

4.3.4 Comparison between Project Durations Obtained from RAIRFNET Using Neurofuzzy Metamodel and Simulation

Results of Monte Carlo simulation summarized in Table 4.16 are used to compare with the results provided by RAIRFNET using neurofuzzy metamodel. The project completion times given by the RAIRFNET using the neurofuzzy metamodel to generate the membership function of activity duration are presented by three shapes of internal membership functions (i.e., nil, rectangular, and trapezoidal) based on the assigned values of uncertainty due to systematic and unknown contributions. To enable the comparisons between the RAIRFNET using the Salicone's method and the RAIRFNET using the neurofuzzy metamodel, the same values of uncertainty due to systematic and unknown contributions are examined in the development of the membership function of activity duration.

For different α – cut levels (i.e., 0, 0.25, 0.5, 0.75, and 1), the percent deviations of the random–fuzzy modes from probabilistic means, optimistic durations from and minimum durations and pessimistic duration from maximum durations derived from a triangular distribution are computed. The percent deviations of random–fuzzy duration from duration obtained from the probabilistic methods range from -77.40% to -11.79% for the underestimated values where the random–fuzzy

duration is smaller than the probabilistic result, and 29.05% to 111.85% for the overestimated values, at the level $\alpha = 0$. The wider ranges of uncertainty are obtained by using the neurofuzzy metamodel in the RAIRFNET. The difference between random-fuzzy duration and duration obtained from the probabilistic methods depends on the assigned values of epistemic uncertainty due to systematic and unknown contributions. In addition, the mathematics for random-fuzzy variables increases such difference.

Figure 4.29 shows working durations of project activities for each unit of a bored pile. It can be observed that the RAIRFNET using trapezoidal internal membership function provides the wider range of project completion times than the ones using nil and rectangular internal membership functions. The obtained results are different from the RAIRFNET using the Salicone method of which the use of trapezoidal and rectangular internal membership function provides the widest range of uncertainty. For the RAIRFNET using the neurofuzzy metamodel, the results obtained from the use of rectangular internal membership function are closer to the one using the nil internal membership function because every uncertainty is determined in the network calculation. Similar to the results obtained by applying the RAIRFNET using the Salicone's method, the RAIRFNET applying the neurofuzzy metamodel using the nil internal membership function gives the project completion times that are closer to the simulation results as both of them determine only uncertainty due to the random contribution. As expected, the widest range of uncertainty is presented at α - cut level = 0.

The values of CP of project completion times calculated by the six probabilistic methods, the values of AI and C_{eq} are determined. Values of CP of project completion times particularly computed by applying the probabilistic method using a triangular distribution are shown in Figure 4.30. It can be seen that the membership functions of project completion times for any shape of the internal membership function produced by the RAIRFNET using the neurofuzzy metamodel represent the uncertainty associated with the project completion time in a similar way towards the results given by Monte Carlo simulation. As depicted in Figure 4.30, values of CP are larger than the values of AI and C_{eq} when the project durations are larger than the calculated means. The values of AI are also larger than the values of C_{eq} for any project duration because C_{eq} is more sensitive to the relevance between

the compared fuzzy numbers. Considering effect of shapes of membership functions of durations, the uncertainty range given by the RAIRFNET using nil internal membership functions is found to be the nearest to results given by Monte Carlo simulation. It also shows that the obtained values of AI and C_{eq} depend on the assigned values of epistemic uncertainty due to the systematic and unknown contributions, but CP is not sensitive to these values.

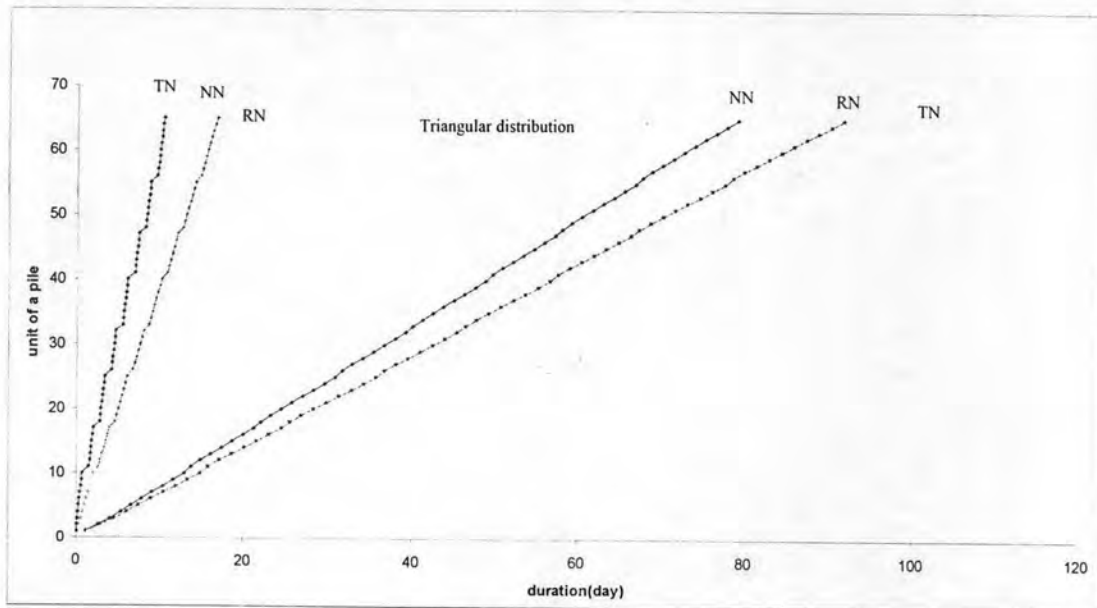

Figure 4.29 Working duration for each unit of a bored pile obtained from RAIRFNET using neurofuzzy metamodel for nil, rectangular, and trapezoidal internal membership functions comparing with simulation results

The membership functions and probability distributions of duration of project completion time for nil internal membership functions are shown in Figure 4.31, where RTriANNL, RTriANNR, TriA, and actual represent left and right parts of membership function obtained from the neurofuzzy metamodel, triangular probability distribution, and actual information of project completion times. To compare the simulation results obtained from the probability distributions and the actual information with the fuzzy numbers, the frequencies of the simulated project completion times are normalized by dividing them with the maximum frequency.

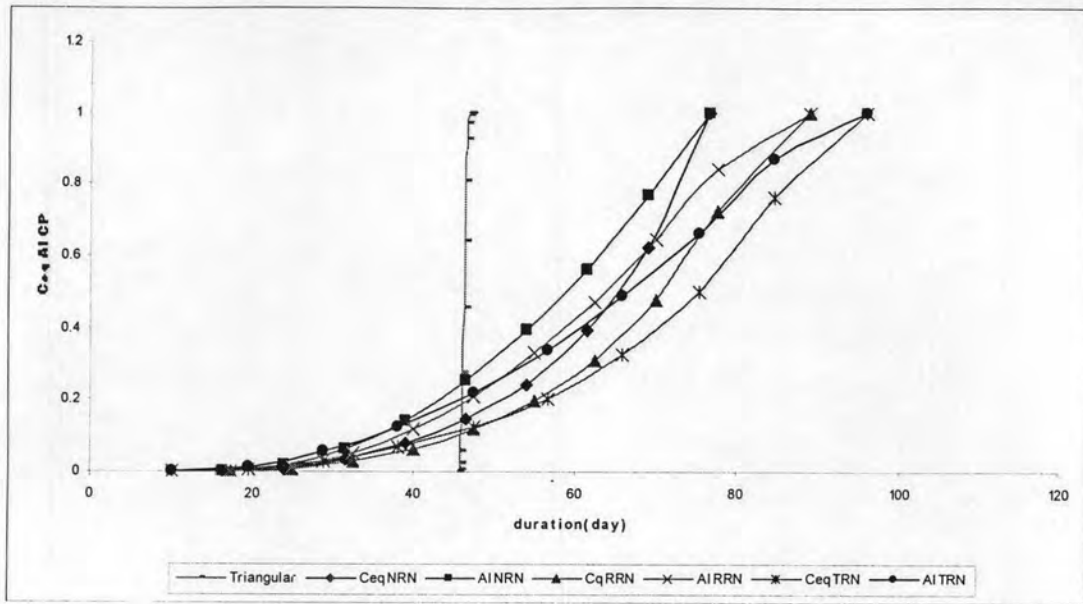

Figure 4.30 CP, AI and C_{eq} for results from RAIRFNET using neurofuzzy metamodel trained on activity duration data

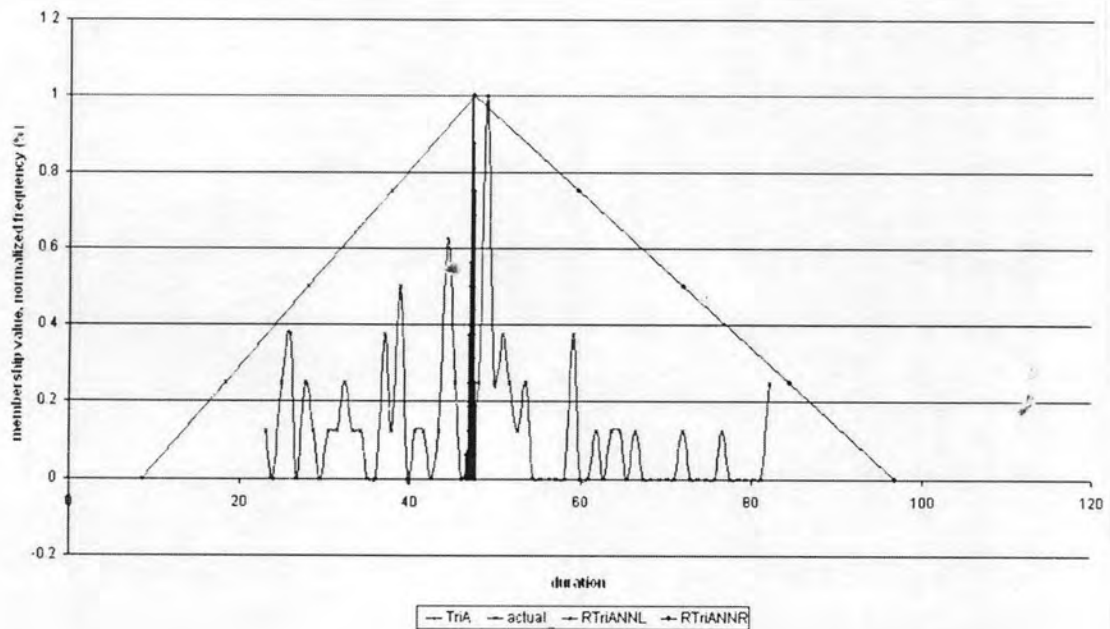

Figure 4.31 Comparison of simulation results for nil internal membership function, actual duration, and triangular distribution – based durations

Results from the group subjective assessment are as shown in Figure 4.32 to 4.33 for data related to nil internal membership functions. These figures are based on different types of probability distributions used to randomly derive data related to project completion times, where membership functions developed based on data derived from triangular, Pert, Pertpg, uniform, and normal probability distributions

are represented by TriANS, Pert, Pertpg, Uni, and Nor, and the left and right parts of membership functions are represented by L and R. Results are in association with different sets of risk factors affecting activity duration, where membership functions developed based on data related to sets of risk factors: R_1, R_2, R_3, R_4 and R_5 ; $R_1; R_2; R_3; R_4; R_5$; R_1, R_2, R_3, R_4 ; R_1, R_2, R_3 ; $R_1, R_2; R_2, R_3, R_4, R_5$; R_2, R_3, R_4 ; R_2, R_3 ; R_3, R_4, R_5 ; R_3, R_4 ; R_4, R_5 are represented by ALL; 1; 2; 3; 4; 5; 1234; 123; 12; 2345; 234; 23; 345; 34; 45, and the left and right parts of membership functions are represented by L and R. The percent deviations of random-fuzzy duration from actual duration range from -3988.32% (Beta distribution for a set of risk factors R_1, R_2, R_3, R_4 and R_5) to 0% (Pertpg distribution for a risk factor R_1) for the underestimated values, and 1.45% (normal distribution for a risk factor R_3) to 71.51% (Beta distribution for a risk factor R_3) for the overestimated values.

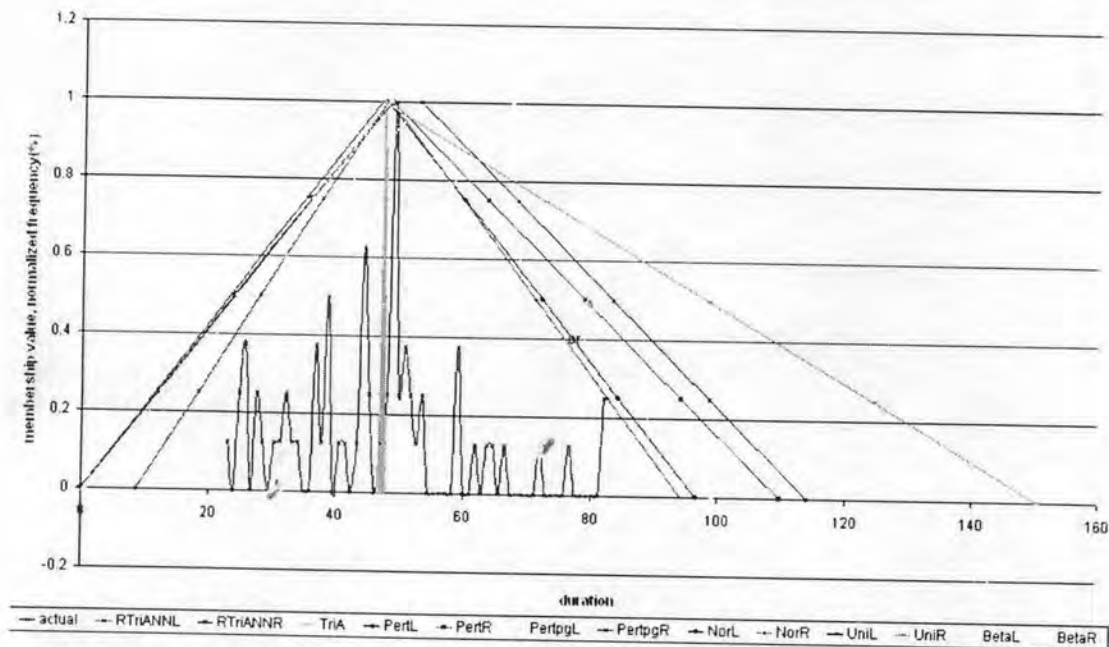

Figure 4.32 Comparison of simulation results for nil internal membership function transformed from different probability distributions of activity duration, actual duration, and triangular distributions – based durations

For rectangular internal membership function, the percent deviations of random-fuzzy duration from actual duration range from -3755.70% (Beta distribution for a set of risk factors R_1, R_2, R_3, R_4 and R_5) to 0% (triangular distribution for a set of risk factors R_2, R_3) for the underestimated values, and 1.15% (triangular distribution

for a set of risk factors R_1, R_2, R_3) to 73.58% (Beta distribution for a risk factor R_3) for the overestimated values.

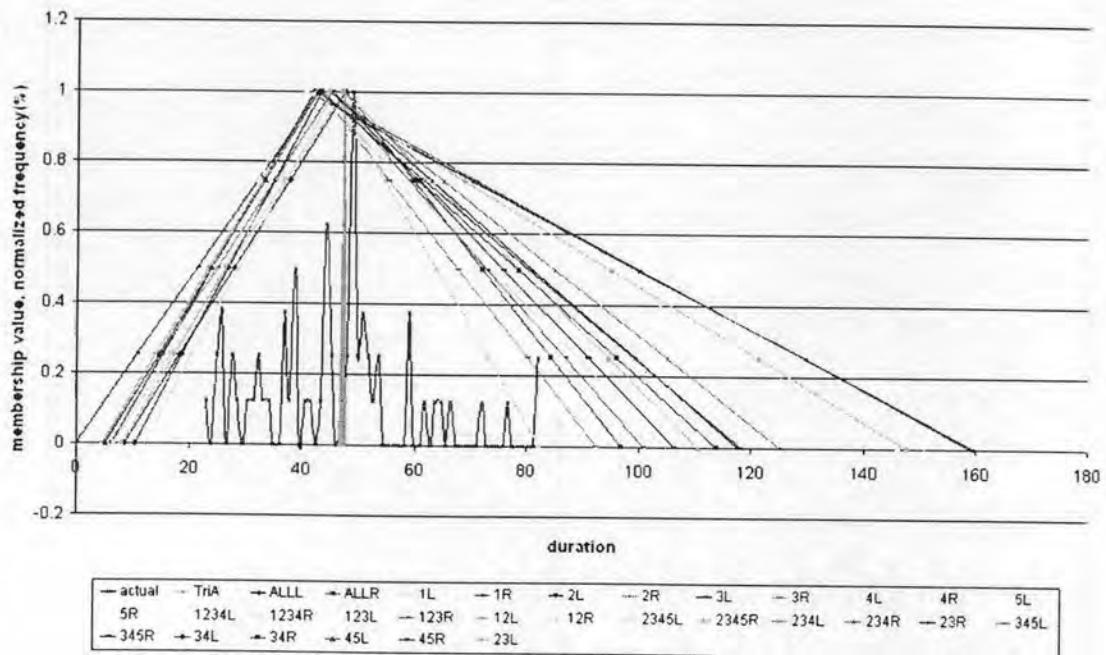

Figure 4.33 Comparison of simulation results for nil internal membership function, actual duration, and triangular distributions – based durations derived from probability distributions related to different sets of risk factors

For trapezoidal internal membership function, the percent deviations of random-fuzzy duration from actual duration range from -1948.63% (Pertpg distribution for a particular risk factor R_3) to 0% (triangular distribution for a set of risk factors R_2, R_3) for the underestimated values, and 1.15% (triangular distribution for a set of risk factors R_1, R_2, R_3) to 604.92% (uniform distribution for a risk factor R_3) for the overestimated values.

Results from the individual subjective assessments are determined.

Considering data provided by a project manager, for nil internal membership function, the percent deviations of random-fuzzy duration from actual duration range from -3901.45% (Beta distribution for a set of risk factors R_1, R_2, R_3, R_4 and R_5) to 0% (triangular distribution for a set of risk factors R_2, R_3) for the underestimated values, and 1.95% (triangular distribution for a set of risk factors R_1, R_2, R_3) to 72.37% (Beta distribution for a risk factor R_3) for the overestimated values. Determining data obtained from an engineer, the percent deviations of random-fuzzy duration from actual duration range from -3709% (Beta distribution for a set of risk factors $R_1, R_2,$

R_3 , R_4 and R_5) to 0% (triangular distribution for a risk factor R_2) for the underestimated values, and 1.17% (triangular distribution for a risk factor R_5) to 73.74% (Beta distribution for a risk factor R_3) for the overestimated values.

Examining data obtained from a foreman, the percent deviations of random-fuzzy duration from actual duration range from -3916.56% (Beta distribution for a set of risk factors R_1 , R_2 , R_3 , R_4 and R_5) to 0% (normal distribution for a risk factor R_3) for the underestimated values, and 1.19% (triangular distribution for a set of risk factors R_2 , R_3) to 72.26% (Beta distribution for a risk factor R_3) for the overestimated values.

For results related to rectangular internal membership function for data provided by a project manager, the percent deviations of random-fuzzy duration from actual duration range from -3753.54% (Beta distribution for a set of risk factors R_1 , R_2 , R_3 , R_4 and R_5) to 0% (triangular distribution for a set of risk factors R_3 , R_4) for the underestimated values, and 1.15% (triangular distribution for a set of risk factors R_1 , R_2 , R_3) to 72.89% (Beta distribution for a risk factor R_3) for the overestimated values. Determining data obtained from an engineer, the percent deviations of random-fuzzy duration from actual duration range from -3450.42% (Beta distribution for a set of risk factors R_1 , R_2 , R_3 , R_4 and R_5) to 0% (normal distribution for a risk factor R_4) for the underestimated values, and 1.09% (pert distribution for a risk factor R_4) to 76.13% (Beta distribution for a risk factor R_3) for the overestimated values. Examining data obtained from a foreman, the percent deviations of random-fuzzy duration from actual duration range from -3840.65% (Beta distribution for a set of risk factors R_1 , R_2 , R_3 , R_4 and R_5) to 0% (normal distribution for a risk factor R_3) for the underestimated values, and 1.66% (triangular distribution for a risk factor R_4) to 71.58% (Beta distribution for a risk factor R_3) for the overestimated values.

For trapezoidal internal membership function, for data provided by a project manager the percent deviations of random-fuzzy duration from actual duration range from -1755.68% (Pertpg distribution for a particular risk factor R_3) to 0% (triangular distribution for a set of risk factors R_2 , R_3 and pert distribution for a risk factor R_3) for the underestimated values, and 2.87% (triangular distribution for a set of risk factors R_2 , R_3) to 557.37% (uniform distribution for a risk factor R_3) for the overestimated values. Determining data obtained from an engineer, the percent deviations of random-fuzzy duration from actual duration range from -2386.76% (Pertpg distribution for a risk factor R_3) to 0% (normal and Beta distribution for a risk factor R_4) for the underestimated values, and 1.09% (pert distribution for a risk factor R_4) to

712.91% (uniform distribution for a risk factor R_3) for the overestimated values. Determining data obtained from an engineer, the percent deviations of random-fuzzy duration from actual duration range from -1420.90% (Pertpg distribution for a risk factor R_3) to 0% (normal distribution for a risk factor R_3) for the underestimated values, and 1.66% (triangular distribution for a risk factor R_4) to 474.86% (uniform distribution for a risk factor R_3) for the overestimated values.

To compare the probability distribution function and membership function developed by considering every uncertainty, the probability of occurrence for each element of the project completion times represented by the membership function is computed. The values for the mean and the standard deviations of the project completion times are determined. The statistical form of frequency of project completion times is used to approximate the probability density function of the project completion times. In this research, simulation is used to generate data related to activity duration based on the parameters of the durations of project activities which are estimates of the mean and standard deviation of duration calculated from the membership functions having nil, rectangular, and trapezoidal internal membership functions. The project completion times are consequently computed based on the simulated activity duration.

To simplify the presentation, only triangular probability distribution functions of activity duration are employed to estimate the project completion times. Duration of activities including drilling, tremie installation, cage installation, concrete pouring, changing machine position, and soil removal which are carried out in a bored pile construction project are determined by the developed simulation model. There are six triangular probability distribution functions over different intervals transformed from the corresponding membership functions. The comparison of simulation results or the normalized frequency of the project completion times obtained by applying the Monte Carlo simulation based on distributions transformed from the nil, rectangular, and trapezoidal internal membership functions obtained from the neurofuzzy metamodel and triangular distribution based durations for a set of risk factors R_1 , R_2 , R_3 , R_4 , and R_5 is performed and the results are displayed in Figure 4.34 to 4.36, where membership functions developed based on data derived from triangular, Pert, Pertpg, uniform, and normal probability distributions are represented by TriANS, Pert, Pertpg, Uni, and Nor, and the left and right parts of membership functions are represented by L and R. A number of simulate replications have been considered for

each distribution. The project completion time is estimated by summing up the simulated activity duration. It can be observed that the obtained normalized frequency is symmetric and its mean is the sum of the means of the distributions of durations of project activities. The support of the normalized frequency depends on the sum of the intervals of activity duration. The shape of the normalized frequency approximates a normal distribution. However, only a small amount of the results fall at the edges of the summed interval. Thus, the support of the obtained normalized frequency is smaller than the sum of the intervals of activity duration. Based on the obtained results, the expectations of the Central Limit Theorem where the sum of random variables tends to a normal distribution can be confirmed.

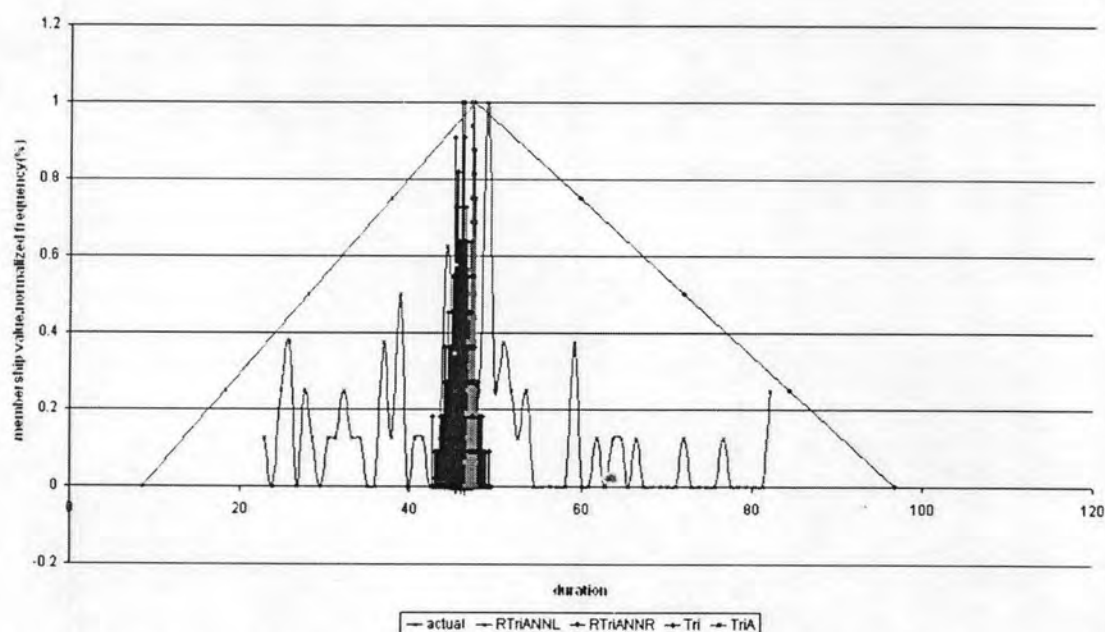

Figure 4.34 Comparison of simulation results for nil internal membership function, actual duration, and triangular distributions – based durations derived from initial and transformed probability distributions of activity duration

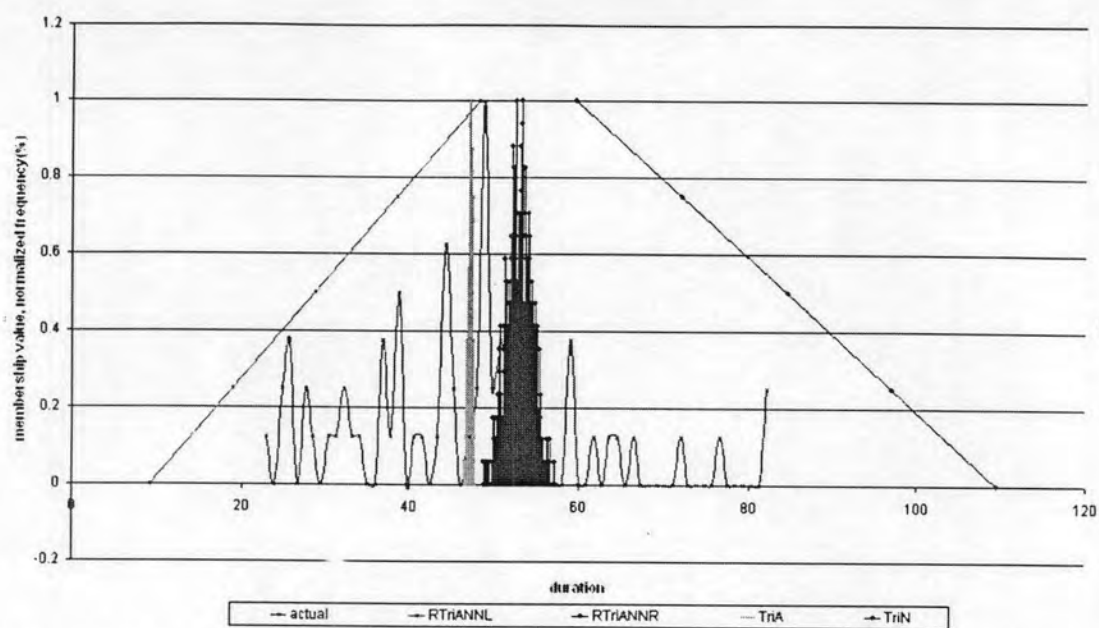

Figure 4.35 Comparison of simulation results for rectangular internal membership function, actual duration, and triangular distribution – based durations derived from initial and transformed probability distributions of activity duration

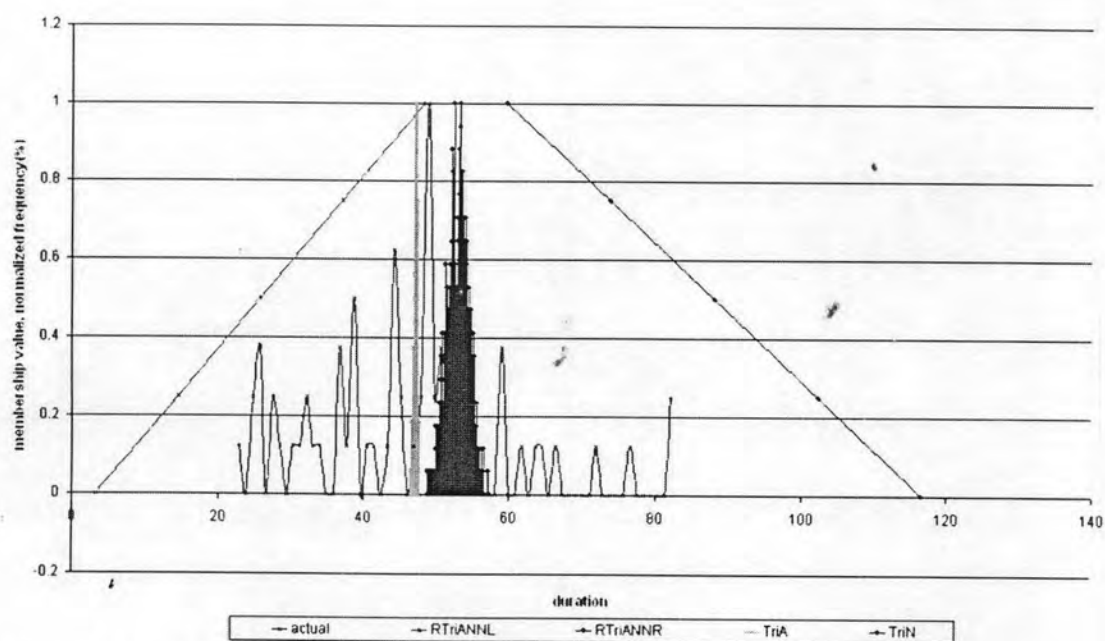

Figure 4.36 Comparison of simulation results for trapezoidal internal membership function, actual duration, and triangular distribution – based durations derived from initial and transformed probability distributions of activity duration

4.3.5 Comparison between Project Completion Times Obtained from Salicone's Method and Neurofuzzy Metamodel Trained on Data Associated with Project Completion Times

As described previously, the random-fuzzy project durations obtained using the Salicone's method and neurofuzzy metamodel trained on data associated with project completion times are represented by three shapes of internal membership functions (i.e., nil, rectangular, and trapezoidal). The percent deviations of the random-fuzzy modes from probabilistic means, optimistic duration from minimum durations and pessimistic duration from maximum durations for particular distributions are computed.

The percent deviations of random-fuzzy durations provided by the Salicone's method from durations obtained from the probabilistic methods (i.e., -14.97% to -2.11% and 5.01% to 16.62%) are smaller than the ones provided by the neurofuzzy metamodel (i.e., -25.91% to -1.09% and 0.24 % to 21.95%) for the underestimated and overestimated values, respectively. While the Salicone's method processed on data drawn randomly based on uniform distribution provides the highest deviation (i.e., 16.62%), the neurofuzzy metamodels trained on data drawn randomly based on Beta distribution provide the highest deviation (i.e., 21.95%). However, the lowest deviations (-14.97% and -25.91%) are provided by training the Salicone's method and neurofuzzy metamodel, respectively, on data drawn based on Pertpg distribution.

Considering values of CP of project completion times, values of AI and values of C_{eq} , it can be seen that the membership function of project completion times only for the nil internal membership function produced by the Salicone's method is reasonably close to the corresponding result generated by Monte Carlo simulation. This is because the Salicone's method using the nil internal membership function eliminates the systematic and unknown contributions like the probabilistic methods. Although the simulation results behave in a similar way towards the project completion time provided by the neurofuzzy metamodel for any type of the internal membership functions, the project completion times produced by the Salicone's method are closer to the simulation results than the ones provided by the neurofuzzy metamodel. Theoretically, the Salicone's method produces scheduling outputs based on the means and variances of a probability density function using the probabilistic methods.

One of the major differences between the results provided by Salicone's method and neurofuzzy metamodel is the fuzzy rule base. The former provides only membership functions representing project completion times and the values of risk variables, while the later provides either the membership functions of input – output variables (i.e., risk variables and project completion times) or the fuzzy IF – THEN rules. Thus, the fuzzy system obtained from neurofuzzy metamodel are more interpretable and applicable to construction projects. Additional data, which are usually unavailable and depend on human subjectivity, are required to improve the fuzzy rule base without the application of the neurofuzzy metamodel.

Figure 4.37 shows membership functions and probability distributions of duration of project completion time for nil internal membership functions, where RTriANSL, RTriANSR, RTriANNL, RTriANNR, TriA, and actual represent left and right parts of membership function obtained from the Salicone's method and neurofuzzy metamodel, triangular probability distribution, and actual information of project completion times. To compare the simulation results and the actual information with the fuzzy numbers, the frequencies of the project completion times are normalized by dividing them with the maximum frequency.

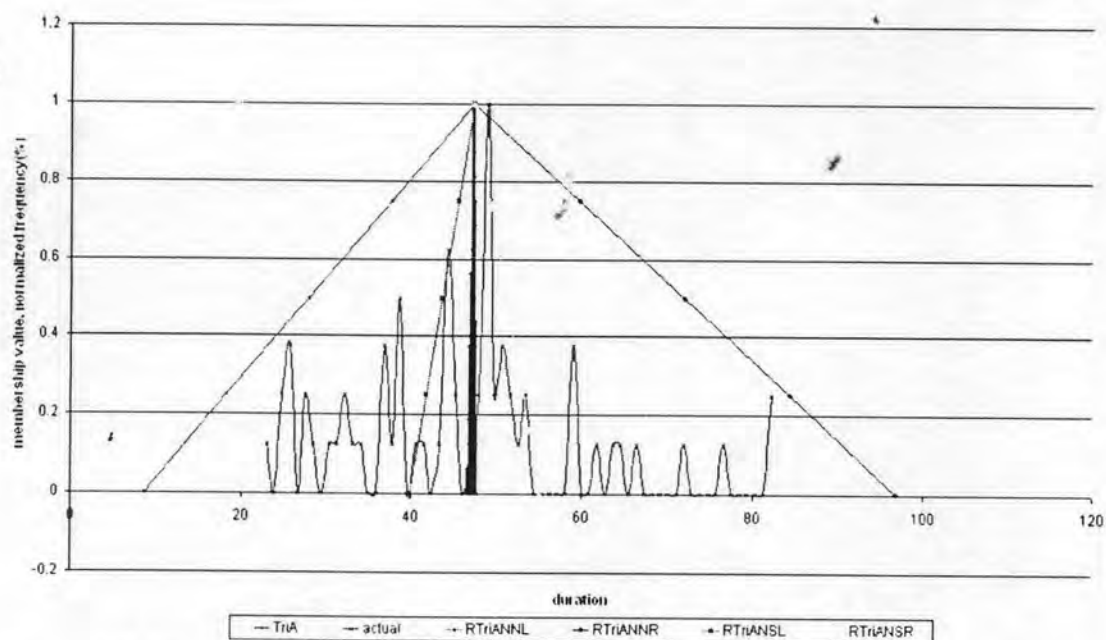

Figure 4.37 Comparison of simulation results for nil internal membership function, actual duration, and triangular distribution – based durations

For information from a group subjective assessment, for data related to nil, internal membership functions, Figure 4.38 to 4.39 display results based on different

types of probability distributions used to randomly derive data related to project completion times, where membership functions developed based on data derived from triangular, Pert, Pertpg, uniform, and normal probability distributions are represented by TriANS, Pert, Pertpg, Uni, and Nor, and the left and right parts of membership functions are represented by L and R. Results are in association with different sets of risk factors affecting activity duration, where membership functions developed based on data related to sets of risk factors: R_1, R_2, R_3, R_4 and R_5 ; $R_1; R_2; R_3; R_4; R_5$; R_1, R_2, R_3, R_4 ; R_1, R_2, R_3 ; R_1, R_2 ; R_2, R_3, R_4, R_5 ; R_2, R_3, R_4 ; R_2, R_3 ; R_3, R_4, R_5 ; R_3, R_4 ; R_4, R_5 are represented by ALL; 1; 2; 3; 4; 5; 1234; 123; 12; 2345; 234; 23; 345; 34; 45, and the left and right parts of membership functions are represented by L and R.

It is found out that results provided by the neurofuzzy metamodel are closer to the actual durations. The neurofuzzy metamodel provides 22.18 days for nil and rectangular internal membership function and 20.18 days for trapezoidal internal membership function for triangular distribution for a risk factor R_4 and 26.42 days for all shapes of internal membership functions for triangular distribution for a set of risk factors R_2, R_3, R_4 , and R_5 that are closer to the minimum actual duration (22.97 days) than 39.01 days for uniform distribution for a risk factor R_4 provided by the Salicone's method. For the mean actual duration (45.14 days), the former provides 45.17 days for triangular distribution for a set of risk factors R_1, R_2 , and R_3 , while the later provides 45.05 days for triangular distribution for a set of risk factors R_1, R_2, R_3 and R_4 for all shapes of internal membership functions.

For the maximum actual duration (82.15 days), the neurofuzzy metamodel provides 80.36, 83.36, and 85.36 days for nil, rectangular, and trapezoidal internal membership functions for normal distribution for a risk factor R_3 and 82.24 days for all shapes of internal membership functions for triangular distribution for a set of risk factors R_1, R_2, R_3 , and R_4 , while the Salicone's method provides 52.36, 55.36, and 57.35 days for nil, rectangular, and trapezoidal internal membership functions for Pertpg distribution for a set of risk factors R_1, R_2, R_3, R_4 and R_5 .

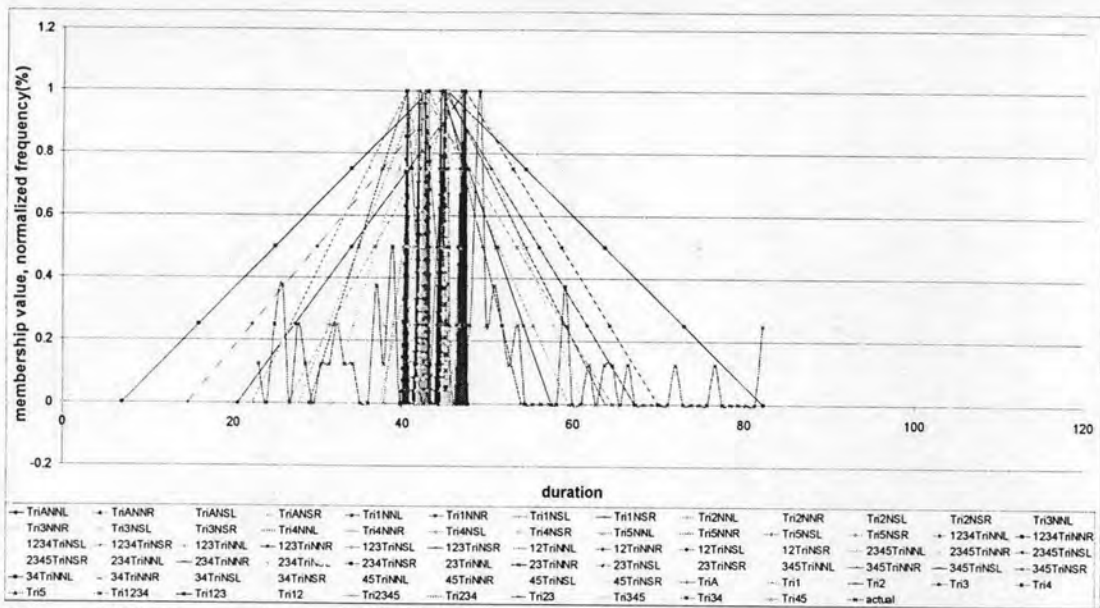

Figure 4.38 Comparison of simulation results for nil internal membership function transformed from different probability distributions of activity duration, actual duration, and triangular distributions – based durations

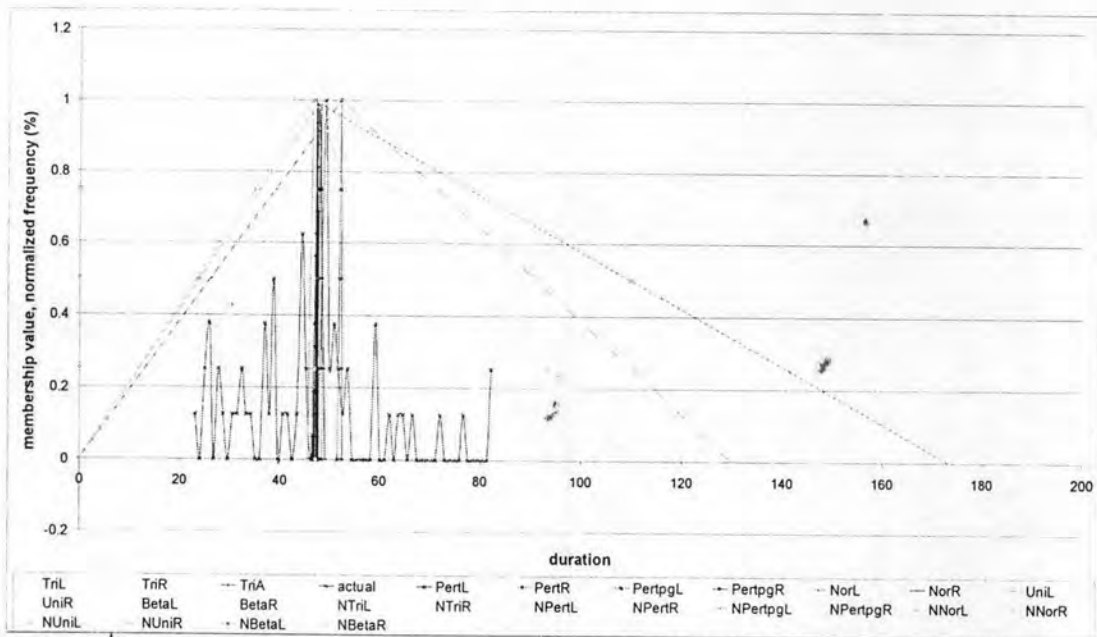

Figure 4.39 Comparison of simulation results for nil internal membership function, actual duration, and triangular distributions – based durations derived from probability distributions related to different sets of risk factors.

For information from any individual subjective assessment, results provided by a project manager for the neurofuzzy metamodel are closer to the actual durations. The neurofuzzy metamodel provides 23.22 days for nil and rectangular internal membership function and 21.46 days for trapezoidal internal membership function for

triangular distribution for a set of risk factors R_2 , R_3 , R_4 , and R_5 and 19.49 days for nil and rectangular internal membership function and 17.73 days for trapezoidal internal membership function for triangular distribution for a risk factor R_4 that are closer to the minimum actual duration (22.97 days) than 34.28 days for nil and rectangular internal membership function and 32.53 days for trapezoidal internal membership function for uniform distribution for a risk factor R_4 provided by the Salicone's method. For the mean actual duration (45.14 days), the neurofuzzy metamodel provides 45.17 days for triangular distribution for a set of risk factors R_1 , R_2 , and R_3 , while the Salicone's method provides 39.60 days for nil internal membership function and 42.24 for rectangular and trapezoidal internal membership functions for triangular distribution for a set of risk factors R_1 , R_2 , R_3 and R_4 for all shapes of internal membership functions. For the maximum actual duration (82.15 days), the neurofuzzy metamodel provides 82.11, 82.93, and 83.42 days for nil, rectangular, and trapezoidal internal membership functions for uniform distribution for a risk factor R_3 , normal distribution for a risk factor R_1 , normal distribution for a risk factor R_4 , while the Salicone's method provides 46.02, 48.65, 50.41 days for nil, rectangular, and trapezoidal internal membership functions for Pertpg distribution for a set of risk factors R_1 , R_2 , R_3 , R_4 and R_5 .

For information provided by an engineer, the neurofuzzy metamodel provides results that are closer to the actual durations. The neurofuzzy metamodel provides 22.18 days for nil and rectangular internal membership function for normal distribution for a risk factor R_1 and 22.62 days for trapezoidal internal membership function days for triangular distribution for a risk factor R_4 that are closer to the minimum actual duration (22.97 days) than 43.73 days for nil and rectangular internal membership function and 41.49 days for trapezoidal internal membership function for uniform distribution for a risk factor R_4 provided by the Salicone's method. For the mean actual duration (45.14 days), the neurofuzzy metamodel provides 45.17 days for triangular distribution for a set of risk factors R_1 , R_2 , and R_3 , while the Salicone's method provides 50.52 days for nil internal membership function and 53.88 for rectangular and trapezoidal internal membership functions for triangular distribution for a set of risk factors R_1 , R_2 , R_3 and R_4 . For the maximum actual duration (82.15 days), the neurofuzzy metamodel provides 81.40, 81.82, 80.99 days for nil, rectangular, and trapezoidal internal membership functions for normal distribution for

a risk factor R_2 , triangular distribution for a set of risk factors R_1, R_2, R_3, R_4 and R_5 , triangular distribution for a set of risk factors R_1, R_2 , and R_3 .

For information provided by a foreman, the neurofuzzy metamodel provides results that are closer to the actual durations. The neurofuzzy metamodel provides 22.06 days for nil and rectangular internal membership function for triangular distribution for a risk factor R_1 and 22.98 days for trapezoidal internal membership function days for triangular distribution for a risk factor R_5 that are closer to the minimum actual duration (22.97 days) than 30.42 days for nil and rectangular internal membership function and 28.86 days for trapezoidal internal membership function for uniform distribution for a risk factor R_4 provided by the Salicone's method. For the mean actual duration (45.14 days), the neurofuzzy metamodel provides 45.17 days for triangular distribution for a set of risk factors R_1, R_2 , and R_3 , while the Salicone's method provides 40.83, 43.17, and 44.73 days for nil, rectangular, and triangular internal membership function for Pertpg distribution for a set of risk factors R_1, R_2, R_3 and R_4 . For the maximum actual duration (82.15 days), the neurofuzzy metamodel provides 83.21, 85.56, 87.11 days for nil, rectangular, and trapezoidal internal membership functions for triangular distribution for a risk factor R_3 .

4.3.6 Comparison between Project Completion Times Obtained from Salicone's Method Processed on Data Associated with Project Completion Times and RAIRFNET using Salicone's Method Processed on Data Associated with Activity duration

This section is to determine the performance of the Salicone's method applied by using different data sets. The Salicone's method are processed on simulation data associated with project completion times and data associated with activity duration. A probability distribution function is transformed into a membership function, uncertainty due to the systematic and unknown contributions is examined and presented by three shapes of internal membership functions (i.e., nil, rectangular, and trapezoidal).

To estimate the project completion time, none of network calculation is performed for computing the project completion time by using the Salicone's method processed on data associated with the project completion time. The project completion time computed following the steps in the proposed RAIRFNET method on the other hand requires the random-fuzzy durations of project activities to be inputted into the

network calculation. The comparison between results obtained from these two methods is determined at different α – cut levels (i.e., 0, 0.25, 0.5, 0.75, and 1). The comparing results (i.e., percent deviation) are computed.

Considering the comparison between the results based on Salicone's methods and the simulation results, the percent deviations of results obtained from the Salicone's method processed on data associated with project completion times (i.e., -14.97% to -2.11% and 5.01% to 16.62%) for the underestimated and overestimated values are smaller than the ones obtained from the RAIRFNET using the Salicone's method processed on data associated with activity duration (i.e., -23.19% to -11.79% and 2.02% to 47.82%), respectively.

The comparing results show that the difference between the optimistic and pessimistic project durations obtained from the Salicone's method processed on project duration data is larger than the standard deviation calculated for a project completion time. This is because conceptually the difference between optimistic and pessimistic values or the spread of project completion times provided by the Salicone's method are considered as three times of the spread of the project completion time obtained from the Monte Carlo simulation. The spread of project completion times obtained from the RAIRFNET using Salicone's method is larger than the spreads of the project completion times obtained from the Monte Carlo simulation and the Salicone's method processed on project duration data because the concept used to develop the membership function of random-fuzzy activity duration would make the cumulative assigned value of epistemic uncertainty associated with activity duration become far greater than the assigned value of epistemic uncertainty associated with the project completion time. The mathematics for the random-fuzzy numbers using in the RAIRFNET also cause the wide spread because it is able to analyze every uncertainty, simultaneously.

Considering values of CP, values of AI and C_{eq} , for every type of probability distributions contained in the simulation model, the values of AI and C_{eq} of project completion times and the spread of random-fuzzy project completion times for any shape of the internal membership functions (i.e., nil, rectangular, and trapezoidal) produced by RAIRFNET using the Salicone's method tend to be larger than the ones obtained from the Salicone's method processed on data associated with project completion times when the project durations are smaller than the modes and otherwise

beyond the modes. The random–fuzzy durations of the former tend to overestimate their respective values of the later when the durations are smaller than the calculated modes. In other words, the results obtained from the RAIRFNET using the Salicone’s method processed on data associated with activity duration are more uncertain than the one provided the Salicone’s method processed on data associated with project completion times.

The membership functions and probability distributions of duration of project completion time for nil internal membership functions are displayed in Figure 4.40, where RTriANSL, RTriANSR, TriANSL, TriANSR, TriA, and actual represent left and right parts of membership function obtained from RAIRFNET using the Salicone’s method and the Salicone’s method processed on data associated with project completion times, triangular probability distribution, and actual information of project completion times. To perform the comparison between the simulation results obtained from the probability distributions and the actual information with the fuzzy numbers, the frequencies of the project completion times are normalized by dividing them with the maximum frequency. Three types of the internal membership function including nil, rectangular, and trapezoidal internal membership functions are considered in order to enable the comparison between the random–fuzzy numbers representing only the random effect and the ones representing both random and fuzzy effects.

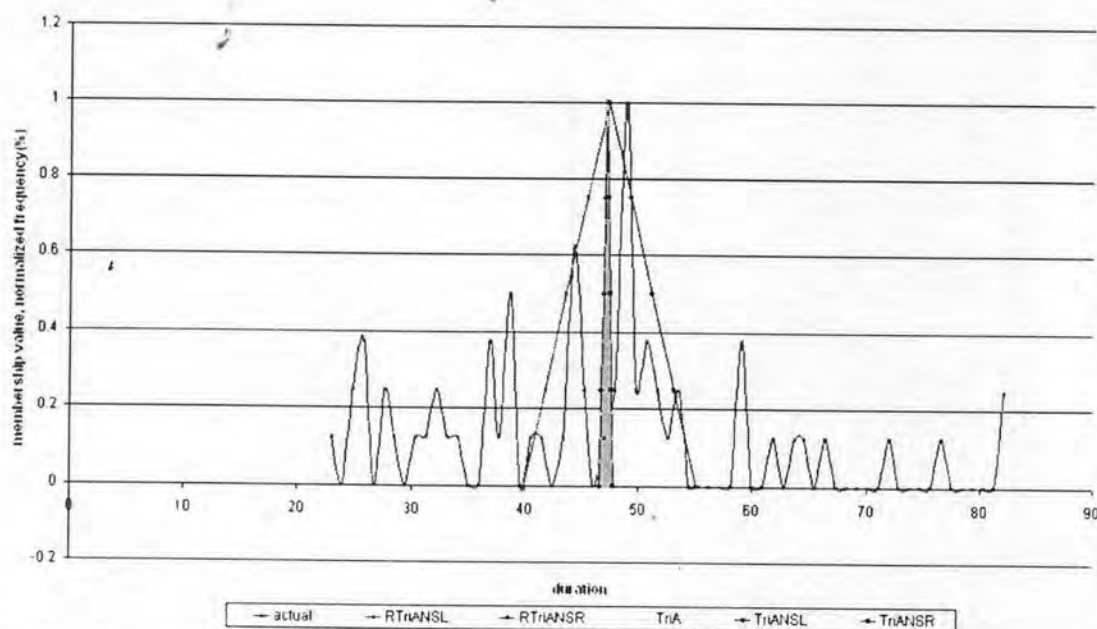

Figure 4.40 Comparison of simulation results for nil internal membership function, actual duration, and triangular distribution – based durations

For information from a group subjective assessment, for data related to nil internal membership functions, Figure 4.41 to 4.42 show results based on different types of probability distributions used to randomly derive data related to project completion times, where membership functions developed based on data derived from triangular, Pert, Pertpg, uniform, and normal probability distributions. Results are in association with different sets of risk factors affecting activity duration.

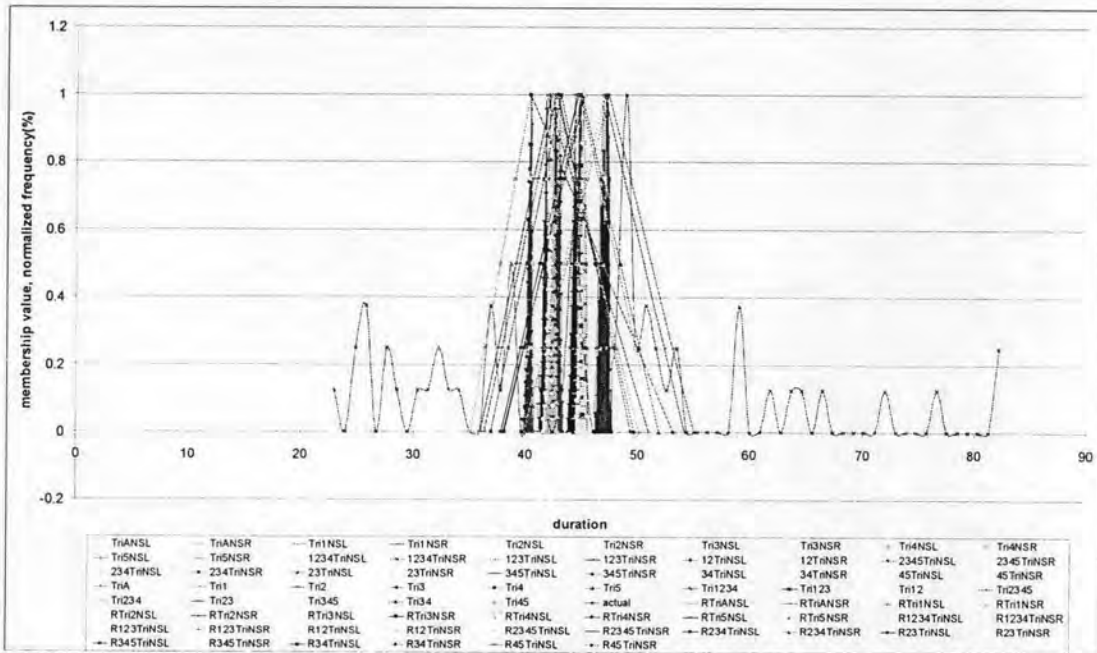

Figure 4.41 Comparison of simulation results for nil internal membership function transformed from different probability distributions of activity duration, actual duration, and triangular distributions – based durations

The comparison between results obtained from the Salicone’s method processed on data associated with project completion times and the ones provided by the RAIRFNET using the Salicone’s method is provided. It is found out that the minimum durations provided by these two methods are even. They provide 39.00 days for nil and rectangular internal membership function and 37.00 days for trapezoidal internal membership function for uniform distribution for a risk factor R_4 that are close to the minimum actual duration (22.97 days). For the mean actual duration (45.14 days), the former provides 45.21 days for triangular distribution for a set of risk factors $R_2, R_3,$ and R_4 , while the later provides 45.06 days for triangular distribution for a set of risk factors R_1, R_2, R_3 and R_4 for the nil internal membership functions. For the rectangular and trapezoidal internal membership functions, the later

provides 45.10 days for triangular distribution for a set of risk factors R_1 and R_2 , while the former provides 45.17 days for triangular distribution for a risk factor R_2 and 45.15 days for uniform distribution for a risk factor R_4 , respectively. For the maximum actual duration (82.15 days), the maximum durations provided by these two methods are even. They provide 55.36 days for Pertpg distribution for a set of risk factors R_1, R_2, R_3, R_4 and R_5 for all shapes of internal membership function.

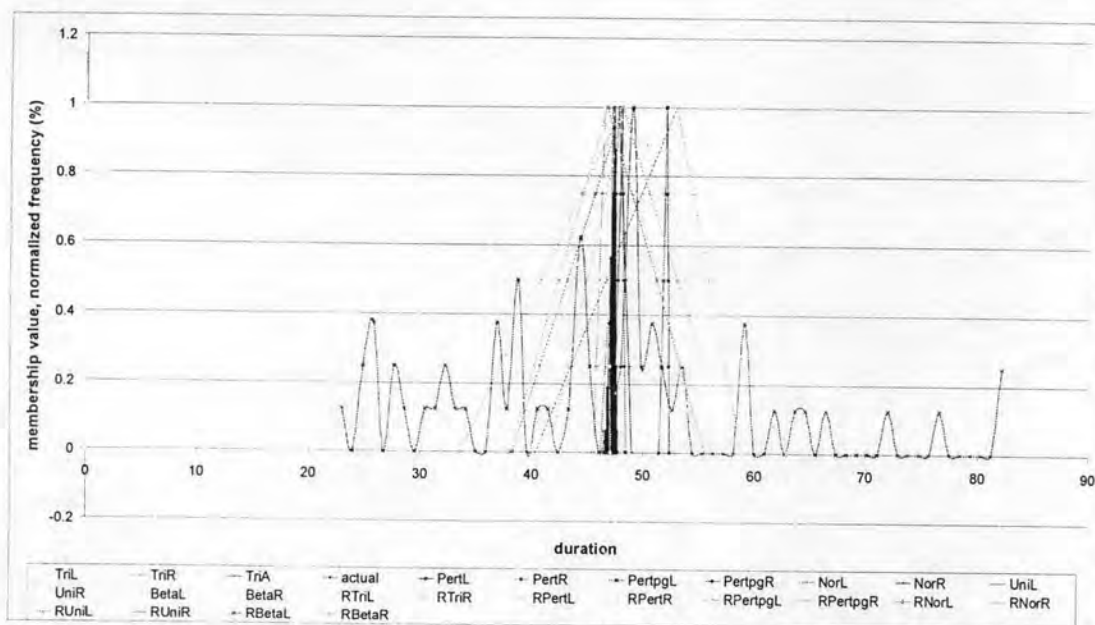

Figure 4.42 Comparison of simulation results for 'nil' internal membership function, actual duration, and triangular distributions – based durations derived from probability distributions related to different sets of risk factors

For information from any individual subjective assessment, minimum durations provided by a project manager for these two methods are even. They provide 34.28 days for nil and rectangular internal membership function and 32.53 days for trapezoidal internal membership function for uniform distribution for a risk factor R_4 . For the mean actual duration (45.14 days), the former provides 45.22 days for Pertpg distribution for a set of risk factors R_1, R_2, R_3, R_4 and R_5 , while the later provides 43.05 days for normal distribution for a set of risk factors R_1, R_2, R_3, R_4 and R_5 for the nil internal membership functions. For the rectangular internal membership functions, the former and later provide 45.19 and 44.73 days for Pert distribution for a set of risk factors R_1, R_2, R_3, R_4 and R_5 . For the trapezoidal internal membership function, the former and later provide 45.34 and 44.93 days for Pertpg distribution for a risk factor R_4 and a risk factor R_5 , respectively. The maximum durations provided

by these two methods are even, which is 46.02, 48.65, and 50.41 days for Pertpg distribution for a set of risk factors R_1 , R_2 , R_3 , R_4 and R_5 for all shapes of internal membership function.

For information provided by an engineer, minimum durations provided by these two methods are even. They provide 43.73 days for nil and rectangular internal membership function and 41.49 days for trapezoidal internal membership function for uniform distribution for a risk factor R_4 . For the mean actual duration, the former provides 45.03 days for uniform distribution for a risk factor R_1 , while the later provides 45.18 days for triangular distribution for a risk factor R_4 for the nil internal membership functions. For the rectangular internal membership functions, the former and later provide 44.73 and 45.18 days for triangular distribution for a risk factor R_1 , and a risk factor R_4 . For the trapezoidal internal membership function, the former and later provide 45.13 days for Pert distribution for a risk factor R_5 and 45.18 days for triangular distribution for a risk factor R_4 . The maximum durations provided by these two methods are even, which is 58.70, 62.06, and 64.31 days for Pertpg distribution for a set of risk factors R_1 , R_2 , R_3 , R_4 and R_5 for all shapes of internal membership function.

For information provided by a foreman, minimum durations provided by these two methods are even. For nil and rectangular internal membership function, they provide 30.42 days, while for trapezoidal internal membership function they provide 28.86 days for uniform distribution for a risk factor R_4 . The maximum durations provided by these two methods are even, which is 40.83, 43.17, and 44.73 days for Pertpg distribution for a set of risk factors R_1 , R_2 , R_3 , R_4 and R_5 for all shapes of internal membership function.

4.3.7 Comparison between Project Completion Time Obtained from Neurofuzzy Metamodel Trained on Data Associated with Project Completion Times and RAIRFNET Using Neurofuzzy Metamodel Trained on Data Associated with Activity duration

The comparison between the performance of the neurofuzzy metamodel trained on data related to project completion times and the RAIRFNET using the neurofuzzy metamodel trained on data related to durations of project activities is performed in this section. To enable the comparisons based on different aspects, data using in the previous subsection in the application of the Salicone's methods are used

to train the corresponding neurofuzzy metamodels. Specifically, different types of probability distributions that are found to fit activity duration are used to generate simulation data, while different shapes (i.e., nil, rectangular, and trapezoidal) of internal membership functions are determined at different α – cut levels (i.e., 0, 0.25, 0.5, 0.75, and 1). Durations of project activities represented by membership functions produced by the neurofuzzy metamodels are inputted into the network calculation in order for the RAIRFNET method to compute the project completion time. The application of the neurofuzzy metamodel trained on data associated with project completion times, on the other hand, requires none of network calculation performed for computing the project completion time. The comparison between project completion times obtained from these two methods is also made at different α – cut levels (i.e., 0, 0.25, 0.5, 0.75, and 1).

The percent deviations of results obtained from the neurofuzzy metamodel trained on project duration data (i.e., -25.91% to -1.09% and 0.24% to 21.95%) for the underestimated and overestimated values are smaller than the ones obtained from the RAIRFNET using the neurofuzzy metamodel trained on data associated with activity duration (i.e., -77.40% to -11.79% and 29.05% to 111.85%), respectively. The comparing results are consistent with the results obtained from the comparison between the Salicone's method and the RAIRFNET using the Salicone's method. The percent deviations of results provided by using the RAIRFNET method regardless methods used to provide activity duration are larger than the application of the Salicone's method and the neurofuzzy metamodel trained on data associated with project completion times. The cumulative values of uncertainties associated with activity duration used to compute the project completion time by using the RAIRFNET cause the larger percent deviations of the results obtained from this method comparing to another. The neurofuzzy metamodel trained on data associated with project completion times on the other hand provide the project completion time based mainly on quality and quantity the training data, which might not appropriately represent uncertainties associated with time required to construct each unit of a bored pile.

Considering values of CP of project durations, values of AI and values of C_{eq} , it can be observed that the values of AI and the values of C_{eq} of project duration for any type of the internal membership functions (i.e., nil, rectangular, and trapezoidal)

produced by RAIRFNET using the neurofuzzy metamodel are mostly larger than the ones produced by the neurofuzzy metamodel trained on the project duration data when the project durations are smaller than the calculated modes and otherwise beyond the modes.

The project duration obtained from the neurofuzzy metamodels trained on project duration data drawn randomly based on different types of probability distributions are consistent disregarding the distributions assumed. The difference between the optimistic and pessimistic project durations is larger than the standard deviation calculated for project completion time. The random-fuzzy durations produced by the RAIRFNET using the neurofuzzy metamodels tend to underestimate their respective values of the neurofuzzy metamodel trained on data associated with project completion times when the project durations are smaller than the calculated modes. In other words, the RAIRFNET using the neurofuzzy metamodels provides the results which are more uncertain than the ones provided directly by using the neurofuzzy metamodel trained on data associated with project completion times.

Comparing results obtained from these two methods with the results produced by simulation, the results of the later (the neurofuzzy metamodel trained on data associated with project completion times) are closer the simulation results as its results depend on the training data or simulation data. To be more specific, the spread of project completion times obtained from the RAIRFNET using neurofuzzy metamodel is larger than the spreads of the project completion times obtained from the neurofuzzy metamodel trained on data associated with project completion times and the Monte Carlo simulation, respectively. The largest spread is given by the RAIRFNET using neurofuzzy metamodel because the concept used to develop the membership function of random-fuzzy activity duration brings about the cumulative assigned values of epistemic uncertainty involved in activity duration due to systematic and unknown contributions which is far greater than the assigned value of epistemic uncertainty involved in the project completion time. Moreover, the mathematics for the random-fuzzy numbers using in the RAIRFNET are able to simultaneously analyze either the random contribution or the systematic and unknown contributions to uncertainty.

Figure 4.43 depicts probability distributions and membership functions of duration of project completion time for nil internal membership functions, where RTriANNL, RTriANNR, TriANNL, TriANNR, TriA, and actual represent left and

right parts of membership function obtained from RAIRFNET using the neurofuzzy metamodel and the neurofuzzy metamodel trained on data associated with project completion times, triangular probability distribution, and actual information of project completion times. To compare between the simulation results obtained from the probability distributions and the actual information and the fuzzy numbers, the frequencies of the simulated project completion times are normalized by dividing them with the maximum frequency. For the sake of comparing the random-fuzzy numbers representing only the random contribution and the ones representing either the random or the systematic and unknown contributions, there are three types of the internal membership function including nil, rectangular, and trapezoidal internal membership functions.

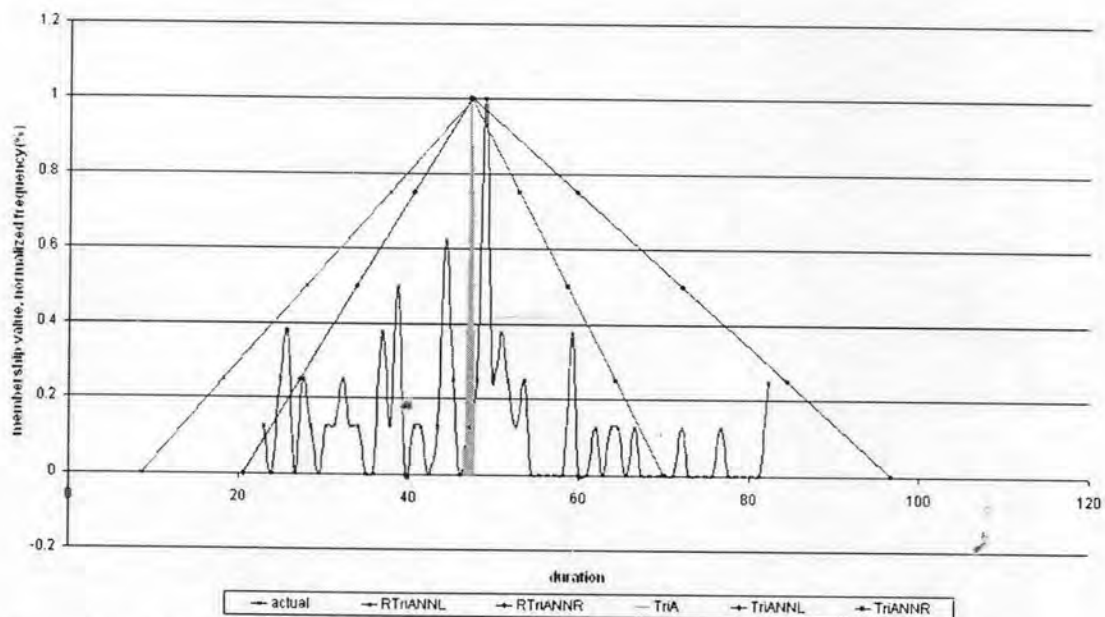

Figure 4.43 Comparison of simulation results for nil internal membership function, actual duration, and triangular distribution – based durations

Considering information acquired from a group subjective assessment, for data related to nil internal membership functions, Figure 4.44 to 4.45 display results based on different types of probability distributions used to randomly derive data related to project completion times, where membership functions developed based on data derived from triangular, Pert, Pertpg, uniform, and normal probability distributions are represented by TriANS, Pert, Pertpg, Uni, and Nor, and the left and right parts of membership functions are represented by L and R. Results are in association with different sets of risk factors affecting activity duration, where membership functions

developed based on data related to sets of risk factors: R_1, R_2, R_3, R_4 and R_5 ; $R_1; R_2; R_3; R_4; R_5; R_1, R_2, R_3, R_4; R_1, R_2, R_3; R_1, R_2; R_2, R_3, R_4, R_5; R_2, R_3, R_4; R_2, R_3; R_3, R_4, R_5; R_3, R_4; R_4, R_5$ are represented by ALL; 1; 2; 3; 4; 5; 1234; 123; 12; 2345; 234; 23; 345; 34; 45, and the left and right parts of membership functions are represented by L and R.

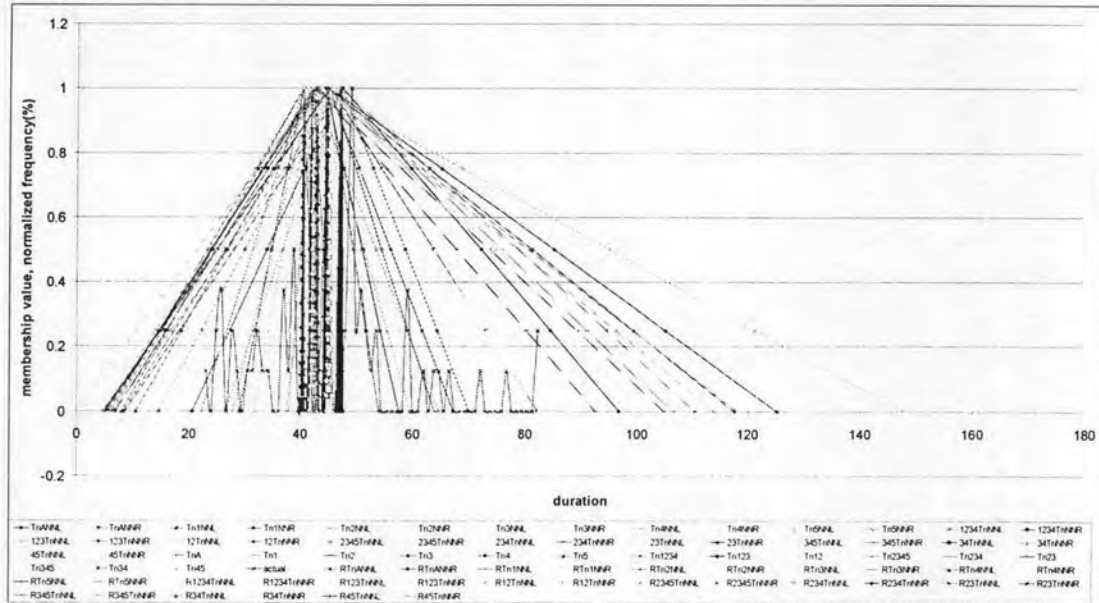

Figure 4.44 Comparison of simulation results for nil internal membership function transformed from different probability distributions of activity duration, actual duration, and triangular distributions – based durations

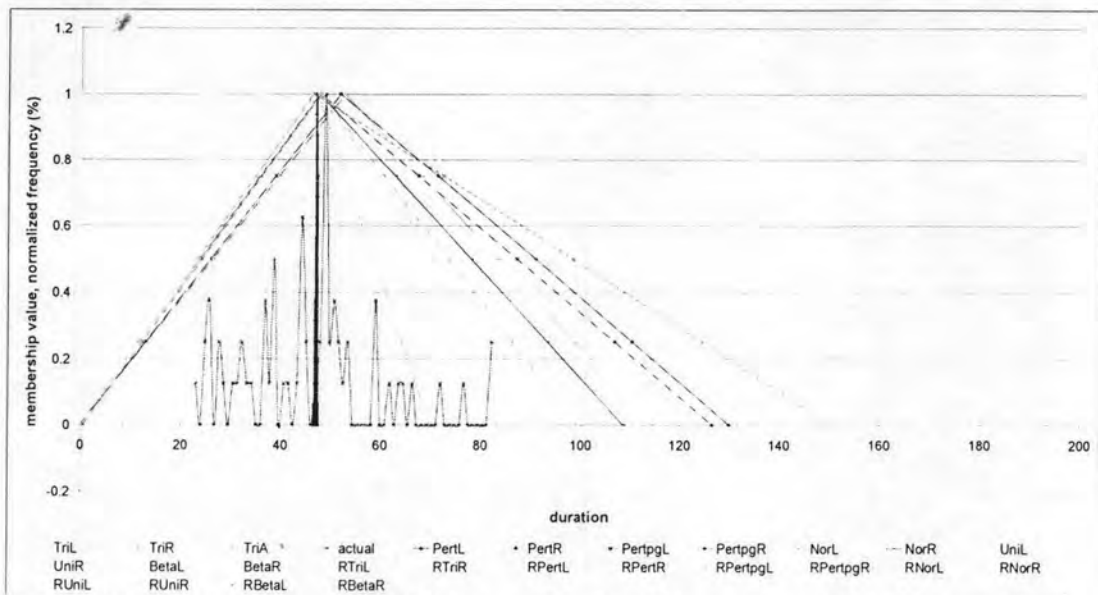

Figure 4.45 Comparison of simulation results for nil internal membership function, actual duration, and triangular distributions – based durations derived from probability distributions related to different sets of risk factors

The comparison between results obtained from the neurofuzzy metamodel trained on data associated with project completion times and the ones provided by the RAIRFNET using the neurofuzzy metamodel is provided. It is found out that the minimum duration provided by the former is 22.18 days for nil and rectangular internal membership function for triangular distribution for a risk factor R_4 and 21.29 days for trapezoidal internal membership function for triangular distribution for a risk factor R_2 and R_3 that are closer to the minimum actual duration (22.97 days) than the ones provided by the later that are 12.06, 12.78, and 5.52 days for triangular distribution for a set of risk factors R_1 , R_2 , R_3 and R_4 for every shape of the internal membership functions. For the mean actual duration (45.14 days), the former provides 45.55 days for Pertpg distribution for a risk factor R_1 , while the later provides 45.24 days for triangular distribution for a set of risk factors R_1 , R_2 , R_3 and R_4 for the nil internal membership functions. For the rectangular and trapezoidal internal membership functions, the former provides 45.35 days for Pert distribution for a risk factor R_2 , while the later provides 45.48 days for triangular distribution for a set of risk factor R_2 and R_3 .

For the maximum actual duration (82.15 days), the maximum durations provided by the former is 82.24 days for triangular distribution for a set of risk factors R_1 , R_2 , R_3 , and R_4 while the later is 81.23 days for uniform distribution for a risk factor R_3 for the nil internal membership function. For rectangular internal membership function, the former provides 83.36 days for normal distribution for a risk factor R_3 and the later provides 90.14 days for normal distribution for a risk factor R_4 . For trapezoidal internal membership function, the former provides 85.24 days for triangular distribution for a set of risk factors R_1 , R_2 , R_3 and R_4 and the later provides 97.27 days for normal distribution for a risk factor R_4 .

For information from any individual subjective assessment, for minimum durations provided by a project manager, the former provides 19.50 days for triangular distribution for a risk factor R_4 for nil and rectangular internal membership function and 22.62 days for triangular distribution for a risk factor R_2 for trapezoidal internal membership function. The later provides 12.32, 12.79, and 6.10 days for triangular distribution for a set of risk factors R_1 , R_2 , R_3 and R_4 for nil, rectangular, and trapezoidal internal membership functions.

For the mean actual duration (45.14 days), the former provides 45.62 days for Pertpg distribution for a set of risk factors R_1 , R_2 , R_3 , R_4 and R_5 , while the later

provides 44.78 days for normal distribution for a risk factor R_3 for the nil internal membership functions. For the rectangular internal membership functions, the former provides 45.26 days for Pert distribution for a risk factor R_3 and 45.62 days for Pertpg distribution for a set of risk factors R_1, R_2, R_3, R_4 and R_5 . For the trapezoidal internal membership function, the former and later provide 45.26 and 45.27 days for Pert distribution for a risk factor R_3 and triangular distribution for a risk factor R_4 , respectively.

For the maximum actual duration, the maximum durations provided by the former is 82.10 days for uniform distribution for a risk factor R_3 while the later is 83.80 days for uniform distribution for a risk factor R_3 for the nil internal membership function. For rectangular internal membership function, the former provides 82.93 days for normal distribution for a risk factor R_1 and the later provides 87.86 days for normal distribution for a risk factor R_4 . For trapezoidal internal membership function, the former provides 83.42 days for normal distribution for a risk factor R_4 and the later provides 93.91 days for normal distribution for a risk factor R_4 .

For information provided by an engineer, the former provides 22.18 days for normal distribution for a risk factor R_4 for nil and rectangular internal membership function and 22.63 days for triangular distribution for a risk factor R_4 for trapezoidal internal membership function. The later provides 12.94, 13.88, and 4.55 days for triangular distribution for a set of risk factors R_1, R_2, R_3 and R_4 for nil, rectangular, and trapezoidal internal membership functions.

For the mean actual duration, the former provides 45.18 days for triangular distribution for a risk factor R_4 , while the later provides 44.96 days for uniform distribution for a risk factor R_5 for the nil internal membership functions. For the rectangular internal membership functions, the former provides 45.18 days for triangular distribution for a risk factor R_4 and 45.12 days for normal distribution for a risk factor R_1 . For the trapezoidal internal membership function, the former and later provide 45.18 and 45.13 days for triangular distribution for a risk factor R_4 and normal distribution for a risk factor R_1 , respectively.

For the maximum actual duration, the maximum durations provided by the former is 81.40 days for normal distribution for a risk factor R_2 while the later is 84.43 days for normal distribution for a risk factor R_4 for the nil internal membership function. For rectangular internal membership function, the former provides 81.82 days for triangular distribution for a set of risk factors R_1, R_2, R_3, R_4 , and R_5 and the

later provides 99.79 days for normal distribution for a risk factor R_4 . For trapezoidal internal membership function, the former provides 80.99 days for triangular distribution for a set of risk factors R_1, R_2, R_3 and the later provides 73.00 days for Pertpg distribution for a set of risk factors R_1, R_2, R_3, R_4 , and R_5 .

For information provided by a foreman, the former provides 22.60 days for triangular distribution for a risk factor R_1 for nil and rectangular internal membership function and 22.98 days for triangular distribution for a risk factor R_5 for trapezoidal internal membership function. The later provides 12.27, 12.51, and 7.44 days for triangular distribution for a set of risk factors R_1, R_2, R_3 and R_4 for nil, rectangular, and trapezoidal internal membership functions.

For the mean actual duration, the former and later provide 44.82 and 45.14 days for triangular distribution for a set of risk factors R_2 and R_3 for the nil internal membership functions. For the rectangular internal membership functions, the former provides 44.44 days for triangular distribution for a set of risk factor R_2, R_3 and R_4 and 45.25 days for uniform distribution for a risk factor R_1 . For the trapezoidal internal membership function, the former and later provide 44.80 and 44.91 days for uniform distribution for a risk factor R_4 and normal distribution for a risk factor R_3 , respectively.

For the maximum actual duration, the maximum durations provided by the former is 83.22 days for triangular distribution for a risk factor R_3 while the later is 80.99 days for normal distribution for a risk factor R_1 for the nil internal membership function. For rectangular internal membership function, the former provides 75.20 days for uniform distribution for a risk factor R_3 , and the later provides 83.80 days for normal distribution for a risk factor R_4 . For trapezoidal internal membership function, the former provides 76.76 days for uniform distribution for a risk factor R_3 and the later provides 86.95 days for normal distribution for a risk factor R_4 .

4.3.8 Comparison between Project Durations Obtained from the RAIRFNET Using Salicone's method and RAIRFNET Using Neurofuzzy Metamodel Trained on Data Associated with Activity duration

This section is to determine the random-fuzzy project completion times obtained from the RAIRFNET using the Salicone's method to develop a membership function of activity duration and the RAIRFNET using neurofuzzy metamodel trained on data associated with activity duration to develop a membership function of activity

duration. To enable the comparison between the project completion times provided by the RAIRFNET, the results are represented by three shapes of internal membership functions (i.e., nil, rectangular, and trapezoidal). At first, results produced by the RAIRFNET using these two methods are compared with simulation results. The percent deviations of random-fuzzy durations provided by the RAIRFNET using the Salicone's method from durations obtained from the simulation (i.e., -23.19% to -11.79% and 2.02% to 47.82%) are smaller than the percent deviations of random-fuzzy durations provided by the RAIRFNET using the neurofuzzy metamodel from durations obtained from the simulation (i.e., -77.40% to -11.79% and 29.05% to 111.85%) for the underestimated and overestimated values, respectively.

Figure 4.46 shows working durations for each unit of a bored pile estimated by applying the RAIRFNET method and simulation. It can be observed that the RAIRFNET using either the Salicone's method or the RAIRFNET method utilizing nil and trapezoidal internal membership functions provides the smallest and widest range of project completion times, respectively. While the RAIRFNET using the Salicone method utilizing trapezoidal and rectangular internal membership functions provides the similar range of project completion times, the RAIRFNET using neurofuzzy metamodel utilizing rectangular internal membership function provides the smaller range of project completion time. The results show that the trapezoidal internal membership function fully accounts for the epistemic uncertain involved in duration. The RAIRFNET applying the neurofuzzy metamodel using the nil internal membership function gives the project completion times that are closer to the simulation results as both of them determines only the random contribution.

Considering values of CP of project completion times, values of AI and C_{eq} , it can be seen that the values of AI and C_{eq} of project duration for any shape of the internal membership functions (i.e., nil, rectangular, and trapezoidal) produced by RAIRFNET using the neurofuzzy metamodel are mostly larger than the ones produced by the RAIRFNET using the Salicone's method when durations are smaller than the calculated modes and otherwise beyond the modes. In addition, the RAIRFNET using the neurofuzzy metamodels provides the project completion times which are more uncertain than the ones provided the RAIRFNET using the Salicone's method.

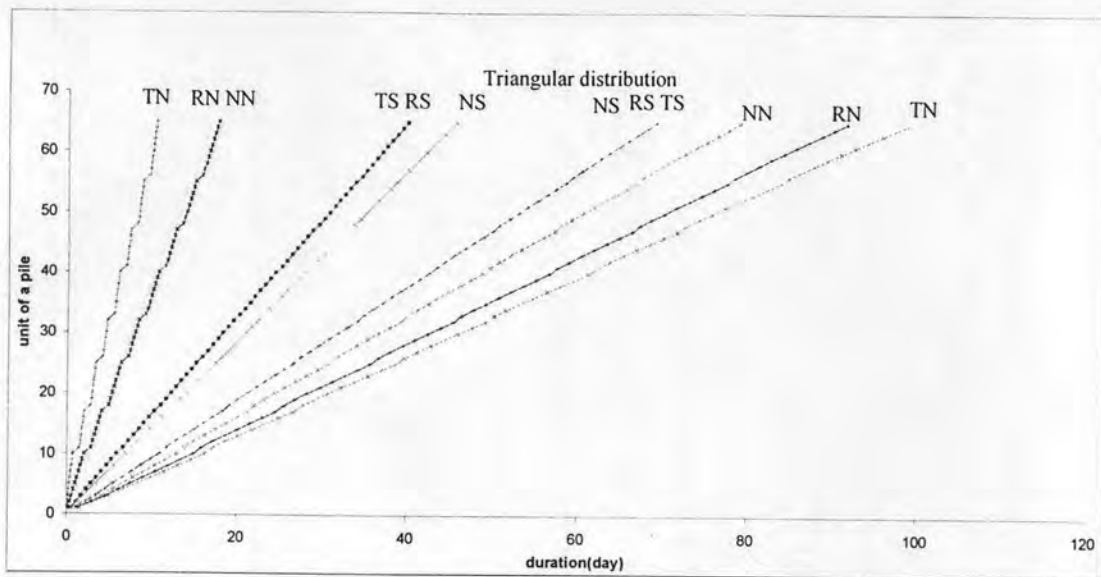

Figure 4.46 Working duration for each unit of a bored pile obtained from RAIRFNET using Salicone's method and RAIRFNET using neurofuzzy metamodel and simulation

It shows that membership functions of activity duration provided by the neurofuzzy metamodel can represent the aleatory uncertainty better than the ones obtained from the Salicone's method. The comparison is provided based on the same values of the epistemic uncertainty which is considered in the development of membership functions by applying these two methods, and the same procedure of the RAIRFNET method used to compute the project completion time based on durations of project activities represented by the established membership functions.

For both the RAIRFNET using the Salicone's method and the RAIRFNET using neurofuzzy metamodel, the largest uncertain project completion time is presented by using the trapezoidal internal membership functions, while the nil internal membership functions reasonably represent the smallest uncertain project completion time. This is because the largest value of systematic and unknown contributions is considered in the network calculation when durations of project activities are represented by the trapezoidal internal membership function. Comparing results obtained from these two methods with the results produced by simulation, only results of the RAIRFNET using the Salicone's method for the nil internal membership function are closer the simulation results as both of them determines only uncertainty due to the random contribution.

Figure 4.47 shows membership functions and probability distributions of duration of project completion time for nil internal membership functions, where RTriANSL, RTriANSR, RTriANNL, RTriANNR, TriA, and actual represent left and right parts of membership function obtained from RAIRFNET using the Salicone's method and RAIRFNET using the neurofuzzy metamodel, triangular probability distribution, and actual information of project completion times. To make the comparison among the simulation results obtained from the probability distributions, the actual information, and the fuzzy numbers, the frequencies of the project completion times are normalized by dividing them with the maximum frequency. Three types of the internal membership function including nil, rectangular, and trapezoidal internal membership functions are considered.

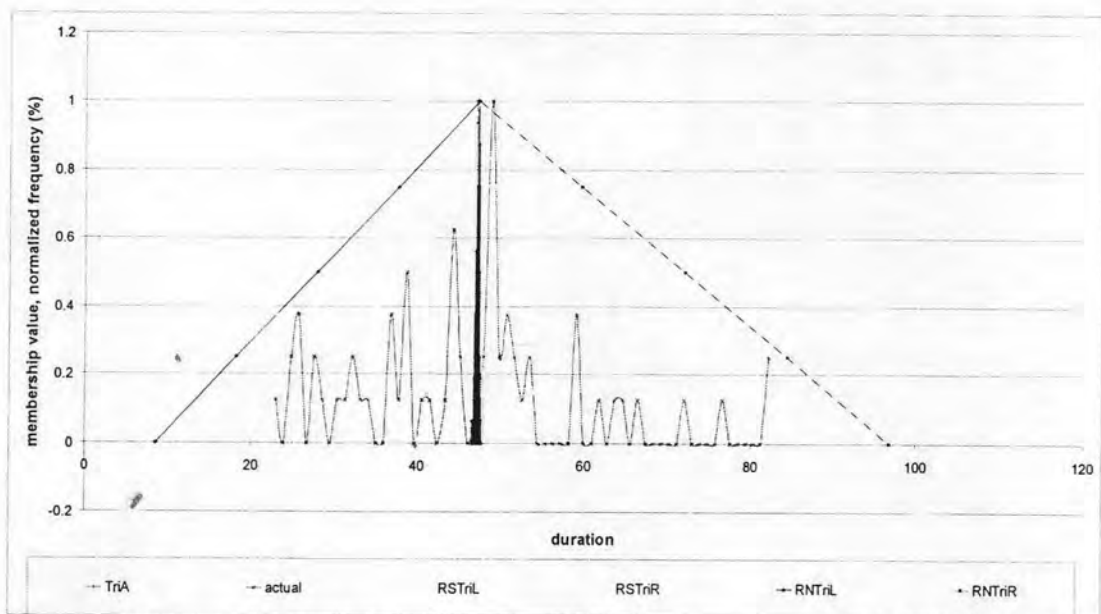

Figure 4.47 Comparison of simulation results for nil internal membership function, actual duration, and triangular distribution – based durations

Based on information from a group subjective assessment, results are as shown in Figure 4.48 to 4.49 based on different types of probability distributions used to randomly derive data related to project completion times, where membership functions are developed based on data derived from triangular, Pert, Pertpg, uniform, and normal probability distributions. Results are in association with different sets of risk factors affecting activity duration.

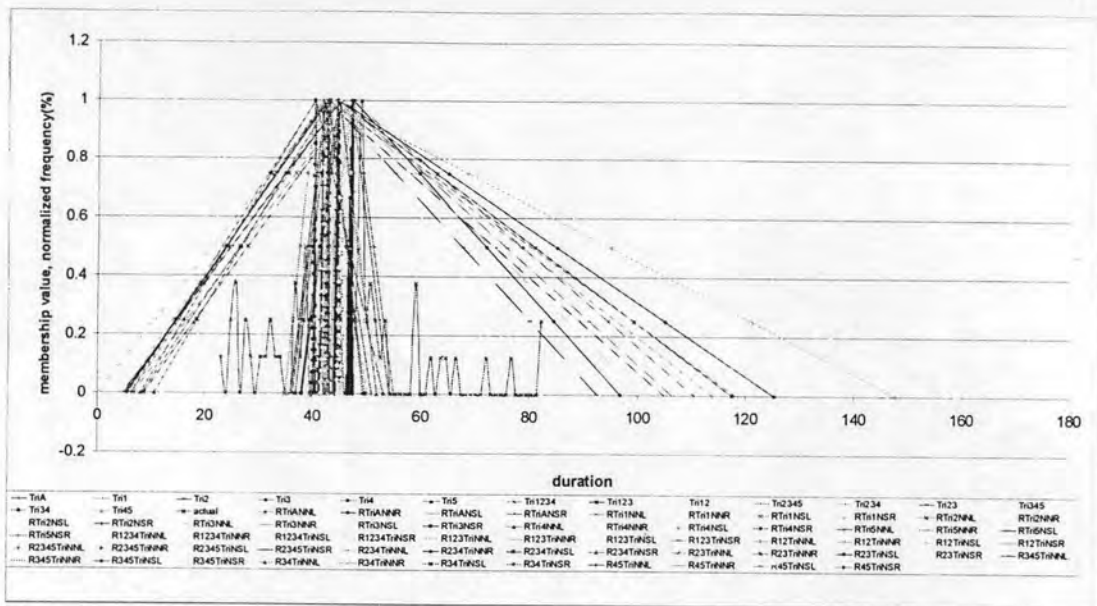

Figure 4.48 Comparison of simulation results for nil internal membership function transformed from different probability distributions of activity duration, actual duration, and triangular distributions – based durations

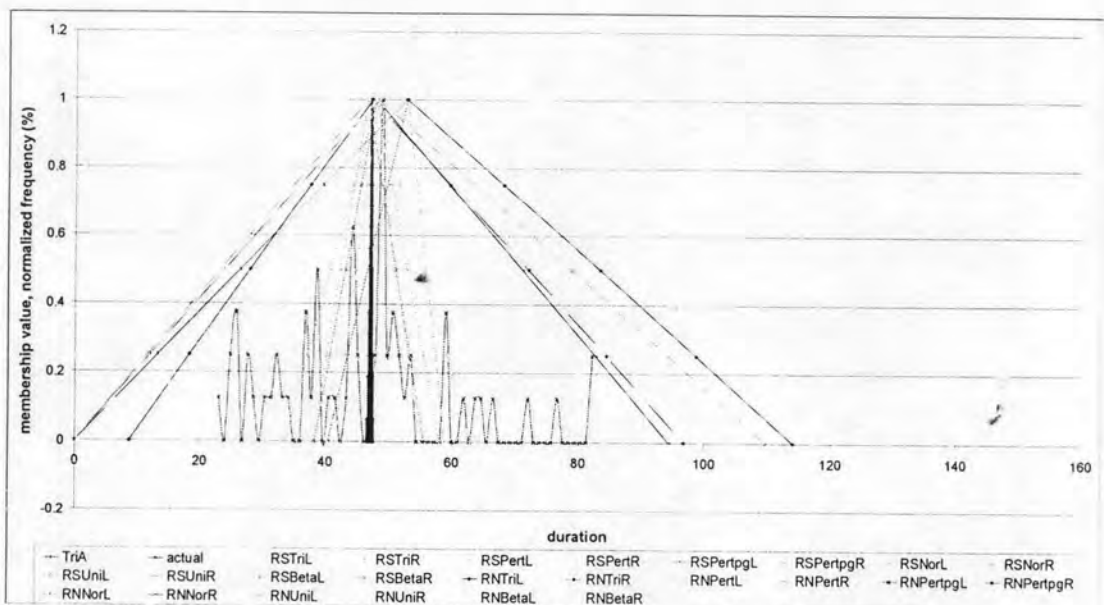

Figure 4.49 Comparison of simulation results for nil internal membership function, actual duration, and triangular distributions – based durations derived from probability distributions related to different sets of risk factors

Results provided by RAIRFNET using the neurofuzzy metamodel are closer to the actual durations. RAIRFNET using the neurofuzzy metamodel provides 12.05, 12.78, and 5.52 for nil, rectangular, and trapezoidal internal membership functions for triangular distribution for a set of risk factors R_1 , R_2 , R_3 , and R_4 that are far from the minimum actual duration (22.97 days) comparing with 29.10, 29.76, and 24.02 for nil,

rectangular, and trapezoidal internal membership functions for normal distribution for a risk factor R_4 provided by RAIRFNET using the Salicone's method.

For the mean actual duration (45.14 days), the former provides 45.17 days for triangular distribution for a set of risk factors R_1 , R_2 , and R_3 , while the later provides 45.13 days for nil internal membership function for Pertpg distribution for a risk factor R_1 , and 45.48 days for triangular distribution for a set of risk factors R_2 and R_3 for rectangular and trapezoidal internal membership functions. For the maximum actual duration (82.15 days), the former provides 82.28 days for nil internal membership function for triangular distribution for a set of risk factors R_1 , R_2 , R_3 , and R_4 , and 90.14 and 97.27 for rectangular, and trapezoidal internal membership functions for normal distribution for a risk factor R_4 , while the later provides 62.95, 75.80 and 81.00 days for nil, rectangular, and trapezoidal internal membership functions for normal distribution for a set of risk factors R_1 , R_2 , R_3 , R_4 and R_5 .

Results related to any individual subjective assessment are determine. For results provided by a project manager, Figure 4.50 to 4.51 present results based on different types of probability distributions used to randomly derive data related to project completion times and results in association with different sets of risk factors affecting activity duration. Results for RAIRFNET using the neurofuzzy metamodel are far from the actual durations comparing to the one provided by RAIRFNET using the Salicone's method. RAIRFNET using the neurofuzzy metamodel provides 12.32, 12.79, and 6.10 days for nil, rectangular, and trapezoidal internal membership functions for triangular distribution for a set of risk factors R_1 , R_2 , R_3 , and R_4 . RAIRFNET using the Salicone's method provides 32.85, 33.28, and 26.88 days for nil, rectangular, and trapezoidal internal membership functions for normal distribution for a risk factor R_1 .

For the mean actual duration (45.14 days), the former provides 45.17 days for triangular distribution for a set of risk factors R_1 , R_2 , and R_3 , while the later provides 45.03 days for nil internal membership function and 45.30 days for rectangular and trapezoidal internal membership functions for normal distribution for risk factors R_1 or R_4 . For the maximum actual duration (82.15 days), the former provides 81.30 for nil internal membership function for normal distribution for risk factors R_1 , and 87.86 and 93.91 days for rectangular, and trapezoidal internal membership functions for normal distribution for a risk factor R_4 , while the later provides 71.21, 78.06, 83.96

days for nil, rectangular, and trapezoidal internal membership functions for normal distribution for a set of risk factors R_1, R_2, R_3, R_4 and R_5 .

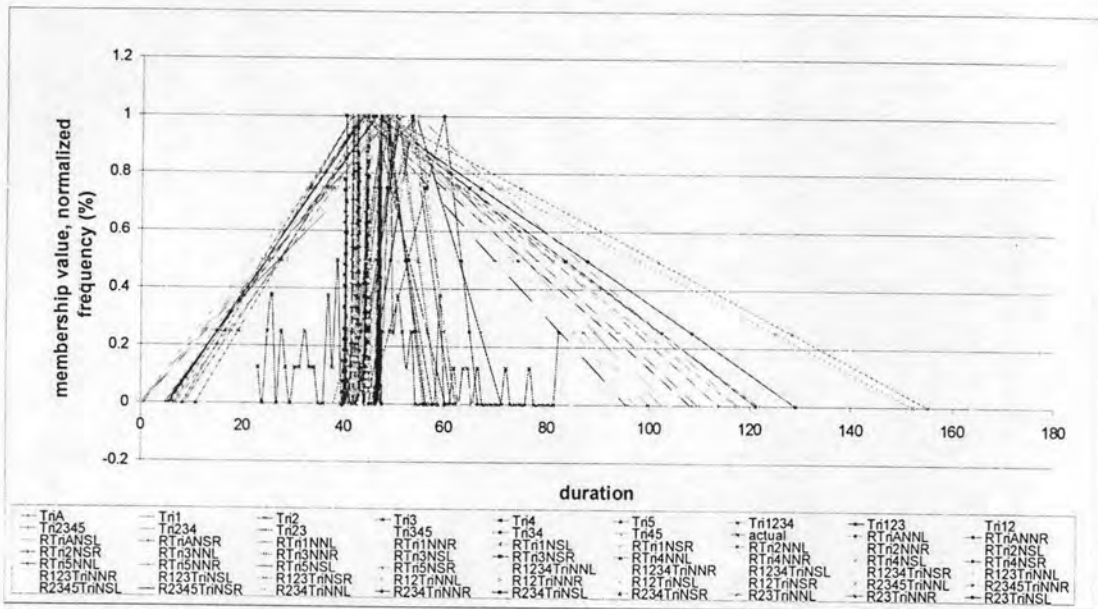

Figure 4.50 Comparison of simulation results for nil internal membership function transformed from different probability distributions of activity duration, actual duration, and triangular distributions – based durations

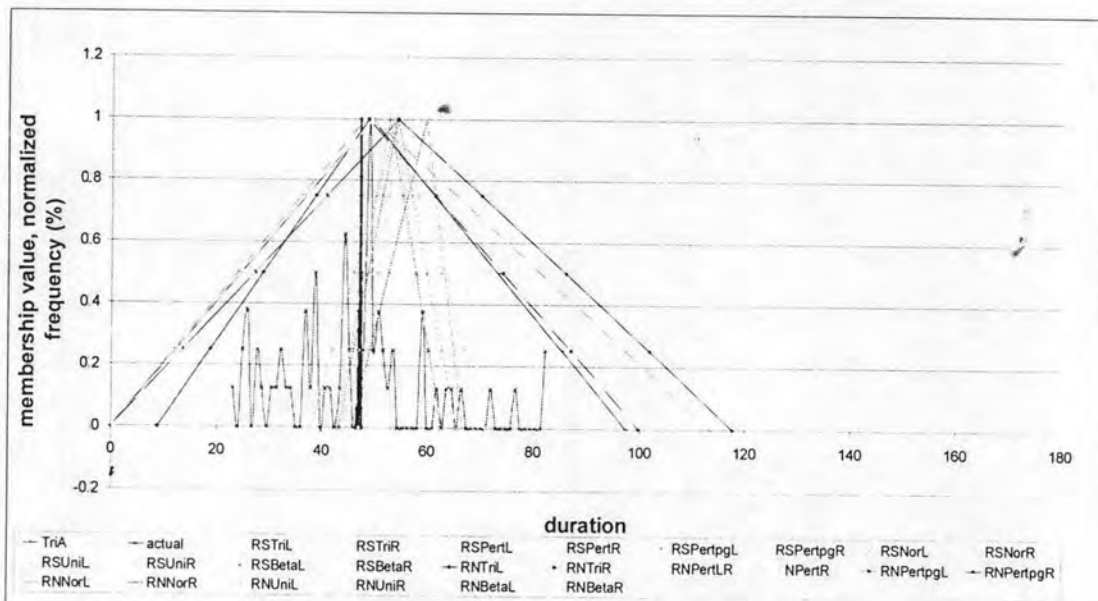

Figure 4.51 Comparison of simulation results for nil internal membership function, actual duration, and triangular distributions – based durations derived from probability distributions related to different sets of risk factors

For information provided by an engineer, RAIRFNET using the neurofuzzy metamodel provides results that are far from the actual durations comparing to the one

provided by RAIRFNET using the Salicone' s method. RAIRFNET using the neurofuzzy metamodel provides 12.93, 13.88, and 4.55 days for nil, rectangular, and trapezoidal internal membership functions for triangular distribution for a set of risk factors R_1 , R_2 , R_3 , and R_4 . RAIRFNET using the Salicone' s method provides 35.82, 36.68, and 26.22 days for nil, rectangular, and trapezoidal internal membership functions for normal distribution for a risk factor R_1 . For the mean actual duration (45.14 days), the former provides 45.17 days for triangular distribution for a set of risk factors R_1 , R_2 , and R_3 , while the later provides 45.01 days for nil internal membership function for triangular distribution for a risk factor R_3 and 45.31 days for rectangular internal membership functions for triangular distribution for risk factors R_2 or R_5 , 42.39 days for trapezoidal internal membership functions for Pertpg distribution for risk factors R_3 . For the maximum actual duration (82.15 days), the former provides 84.43, and 99.79 days for nil and rectangular internal membership functions for normal distribution for a risk factor R_2 , and 73 days for trapezoidal internal membership function for Pertpg distribution for a set of risk factors R_1 , R_2 , R_3 , R_4 and R_5 .

For information provided by a foreman, the results are consistent to other. RAIRFNET using the neurofuzzy metamodel provides results that are far from the actual durations comparing to the one provided by RAIRFNET using the Salicone' s method. RAIRFNET using the neurofuzzy metamodel provides 12.27, 12.50, 7.44 days for nil, rectangular, and trapezoidal internal membership functions for triangular distribution for a set of risk factors R_1 , R_2 , R_3 , and R_4 . RAIRFNET using the Salicone' s method provides 26.98, 27.20, 23.07 days for nil, rectangular, and trapezoidal internal membership functions for normal distribution for a risk factor R_1 . For the mean actual duration (45.14 days), the former provides 45.17 days for triangular distribution for a set of risk factors R_1 , R_2 , and R_3 , while the later provides 45.62 days for nil internal membership function for triangular distribution for a set of risk factors R_3 and R_3 , 45.09 days for rectangular and trapezoidal internal membership functions for triangular distribution for risk factors R_1 , R_2 , R_3 , R_4 . For the maximum actual duration (82.15 days), the former provides 83.48 days for nil internal membership function for uniform distribution for a risk factor R_3 , 83.80 and 86.95 days for rectangular and trapezoidal internal membership function for normal distribution for a risk factor R_4 .

To compare the probability distribution function and membership function developed by considering every uncertainty, the probability of occurrence for each element of the project completion times represented by the membership function is computed. The values for the mean and the standard deviations of the project completion times are determined. The statistical form of frequency of project completion times is used to approximate the probability density function of the project completion times. In this research, simulation is used to generate data related to activity duration based on the parameters of the durations of project activities which are estimates of the mean and standard deviation of duration calculated from the membership functions having nil, rectangular, and trapezoidal internal membership functions. The project completion times are consequently computed based on the simulated activity duration. Figure 4.52 to 4.154 present the comparison of simulation results for nil, rectangular, and trapezoidal internal membership functions obtained from the Salicone's method comparing with the ones provided by the neurofuzzy metamodel and triangular distribution based durations for a set of risk factors R_1 , R_2 , R_3 , R_4 , and R_5 . The obtained normalized frequency for each method is symmetric and its mean is the sum of the means of the distributions of durations of project activities. The means of the normalized frequency obtained from these two methods fall at the middle of the interval of internal membership functions at α - cut level = 0.

4.3.9 Selection of Appropriate Probability Distributions

The probability distributions (i.e., triangular, Pert, Pertpg, normal, uniform, Beta distributions) are selected based on the percent deviation of random-fuzzy duration from actual duration. By keeping other factors affecting the percent deviation constant, impact of the selected type of probability distribution on the accuracy of the estimated project completion time is determined. Using the data provided by the group subjective assessment for nil internal membership function for a set of risk factors R_1 , R_2 , R_3 , R_4 , and R_5 for Salicone's method and neurofuzzy metamodel trained on data associated with project completion time and RAIRFNET using the Salicone's method and neurofuzzy metamodel to develop the membership function of activity duration. The probability distributions giving smallest percent deviation are triangular, uniform, and normal distributions, respectively. Even though the smallest percent deviation provided by the application of RAIRFNET using either the Salicone's method or the neurofuzzy metamodel are obtained from employing the

uniform and normal distributions, the use of the triangular distribution provides considerably small percent deviation. Thus, the triangular probability distribution could be considered as an appropriate probability distribution which can suitably capture data related to activity duration affected by a risk factor or a set of risk factors. Practically, the triangular distribution is commonly used. Although it has no theoretical justification (it is artificially created), it is a very simple and clear distribution to use where the distribution is not known. The results based on the percent deviation of random-fuzzy duration from actual duration confirm that the utilization of the triangular distribution is not only suitable for situations where a simple intuitive understanding is crucial and flexibility is a great advantage, but it also provides accurate results related to activity duration affected by a risk factor or a set of risk factors.

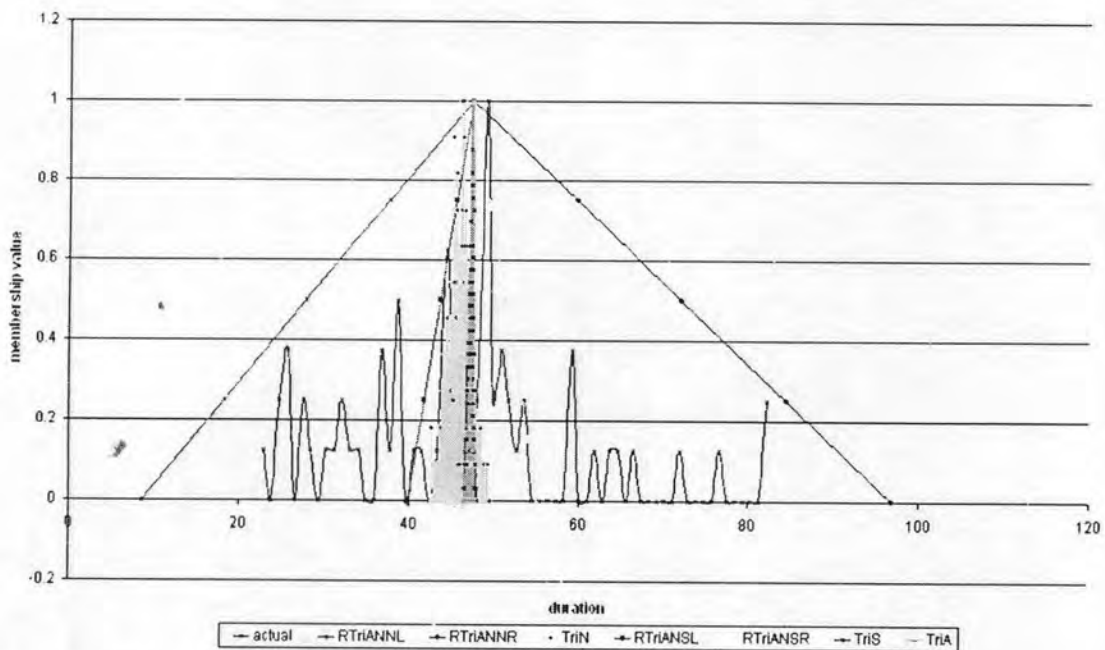

Figure 4.52 Comparison of simulation results for nil internal membership function, actual duration, and triangular distributions – based durations derived from initial and transformed probability distributions of activity duration

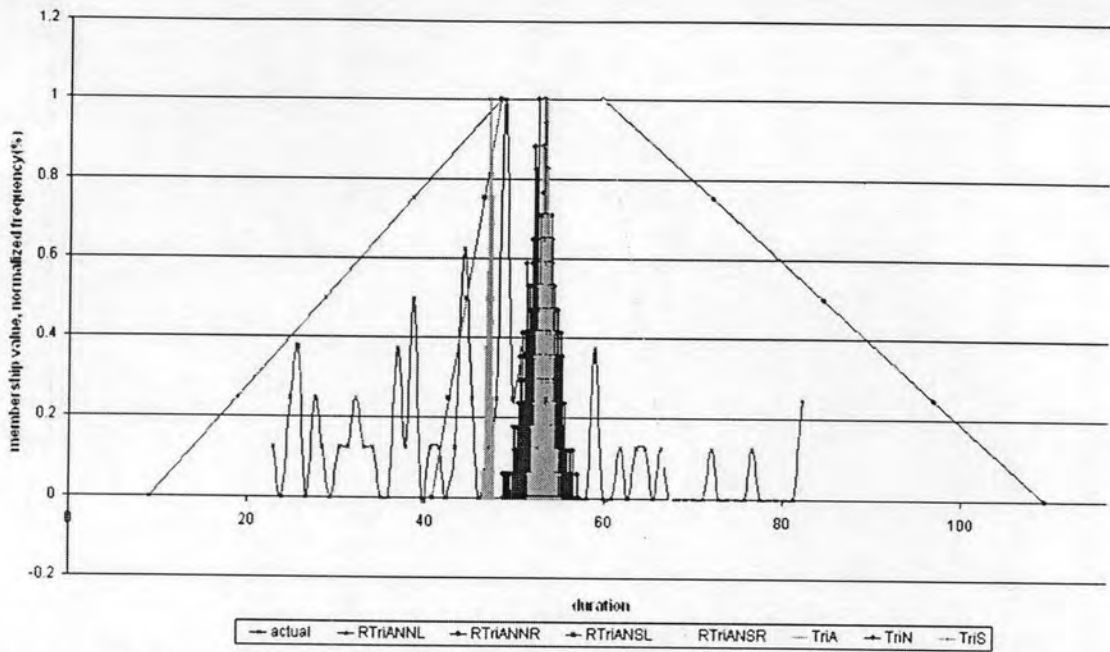

Figure 4.53 Comparison of simulation results for rectangular internal membership function, actual duration, and triangular distribution – based durations derived from initial and transformed probability distributions of activity duration

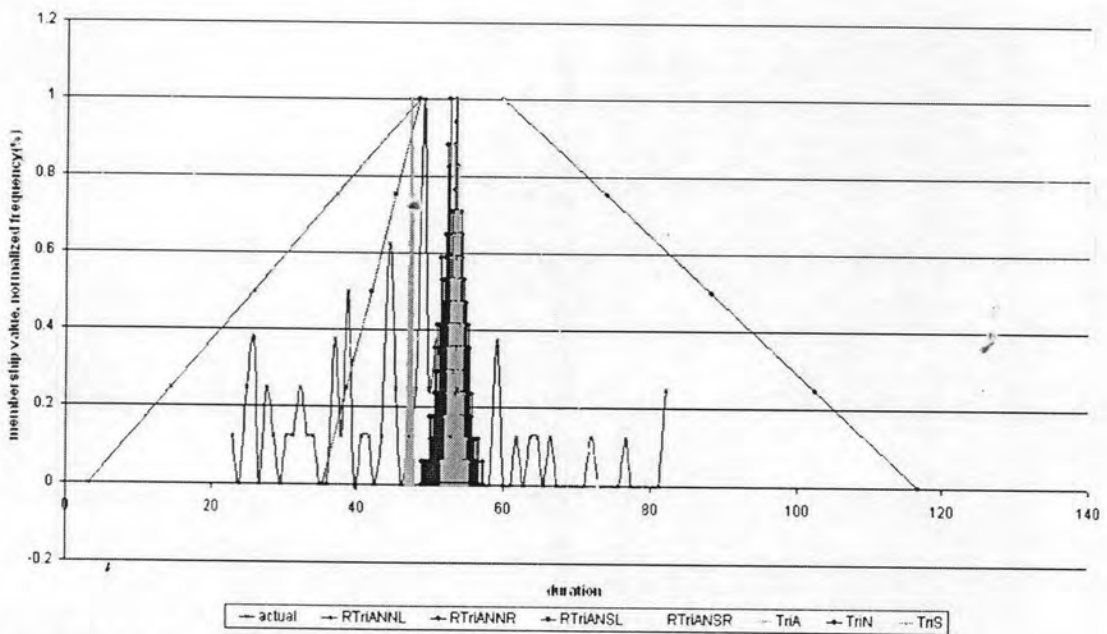

Figure 4.54 Comparison of simulation results for trapezoidal internal membership function, actual duration, and triangular distribution – based durations derived from initial and transformed probability distributions of activity duration

4.3.10 Identification of Significance Risk Factors

To determine dependencies between risk factors, the more sophisticated method of determining the extent to which the values of risk variables and temporal variable are assigned is used in this research. This method is modified from the sensitivity analysis by using simulation to provide data related to values of risk variables of a particular risk factor or a set of risk factors and the relevant activity duration affected by such risk factor(s). By doing so, the correlations and relationships between the risk factors are considered. The sensitivity analysis is repeated for each risk factor or set of risk factors. The differences between the actual durations and the estimated durations give an indication of the significance of a risk factor or a set of risk factors. By ranking the differences, the relative significance of the risk factors on the activity duration is ordered. The risk factor or the set of risk factors causing the biggest difference is ranked as the most significant one.

It is very communicative and applicable in practice to presenting the assessed significance of a risk factor or set of risk factors by a corresponding linguistic term. Using the boundaries set for each proposed method, for example: very high is more than about 5%, high is 3% to 5%, medium is 2% to 3%, low is 1% to 2%, and very low is less than 1% which are used together with the application of RAIRFNET using the Salicone's method to develop membership functions for a particular type of probability distributions. For example, the percent deviation of random-fuzzy duration from actual duration is 1.15% for triangular distribution for a set of risk factors R_1 , R_2 , R_3 . It means that a set of risk factors R_1 , R_2 , R_3 having impact on an activity j is rated "low". To enhance the improvement of the project scheduling employing the RAIRFNET using the Salicone's method to develop membership functions, only three risk factors (R_1 , R_2 , R_3) are examined.

4.4 Summary

This chapter presents an application of the proposed method that attempts to provide an accurate estimate to reflect reality of a construction project. The proposed method uses three data acquiring approaches to produce information associated with risk affecting activity duration. Historical data, subjective data from professional experience and judgment, and simulation data associated with the calculations based

on the risk assessment and the detailed analysis of the construction process combining with the subjective judgement pertaining to time are used to estimate activity duration. The proposed method also applies mathematics for random fuzzy variables to propagate uncertainty associated with activity duration and compute project completion time. By doing so, the proposed method provides an accurate estimate that covers actual duration and reflects the realities of the considered project.

The comparisons among alternative methods proposed in this research and methods typically used to perform risk assessment and network calculation are also presented in this chapter. Alternative methods proposed in this research include the Salicone's method processed on data associated with project completion times, neurofuzzy metamodel trained on data associated with project completion times, RAIRFNET using Salicone's method processed on data associated with activity duration to develop the membership function of activity duration, and RAIRFNET using neurofuzzy metamodel trained on data associated with activity duration to develop the membership function of activity duration. The performance of alternative methods is compared with the performance of the probability theory – based method (i.e., simulation) by using data from a case study project or a bored piling project.

To enable the comparison, the proposed methods present the project completion times by different shapes of the internal membership functions (i.e., nil, rectangular, trapezoidal) representing the fuzzy part of the random–fuzzy duration. The probability based method presents the project completion times in the statistical form of frequency or cumulative frequency. The frequencies of the project durations are normalized by dividing them with the maximum frequency. Alternatively, the project completion times are given by other measurement methods (i.e., CP, AI, credibility coefficients).

The results obtained from the proposed methods are consistent. The project completion times produced by the RAIRFNET using the neurofuzzy metamodel are mostly larger than the ones produced by the RAIRFNET using the Salicone's method when durations are smaller than the calculated modes and otherwise beyond the modes. In addition, the RAIRFNET method provides the more uncertain project completion times than the Salicone's method and neurofuzzy metamodel trained on data associated with project completion times. The project completion times achieved from the proposed methods are more uncertain than the simulation results.

The comparing results show that the proposed random–fuzzy network calculation contained in the RAIRFNET is able to determine every uncertainty (aleatory and epistemic uncertainty) associated with activity duration and uncertainties associated with the network calculation process. The cumulative value of uncertainties is determined in the calculation of the project completion time.

The project completion times obtained from the Salicone's method and neurofuzzy metamodel trained on data associated with project completion times depend mainly on the training data whether the training data can capture behaviors and relationships between the temporal variable and risk variables or not. The lower ranges of project completion times provided by these two methods comparing with the ranges obtained from the RAIRFNET method indicate that data associated with the project completion time and values of risk variables that are used as the training data cannot represent all uncertainties. Uncertainty associated with activity duration and uncertainty associated with the network calculation discarded by these two methods are determined in the application of the RAIRFNET method.

The comparing results show that uncertainties involved in the estimation of the project completion times are better addressed by the proposed methods which are based on the random–fuzzy concept because either random or fuzzy part of duration is examined. The results given by the proposed methods depend mainly on the assigned values of epistemic uncertainty due to systematic and unknown contributions which are theoretically eliminated by using any probability theory based method.

The determination of uncertainty due to systematic and unknown contributions in the development of the membership functions of activity duration considerably influences the range of project completion times. The assigned values of fuzzy effects are represented by the rectangular, and trapezoidal internal membership functions. The nil internal membership functions reasonably represent the small uncertain project completion time as only values of uncertainty due to the random contribution is determined in the network calculation. The results are close the simulation results as both of them determine only uncertainty due to the random contribution, but these two methods cannot provide results covering the actual duration. The methods determining uncertainty due to systematic and unknown contributions in the development of the membership functions of activity duration provide the more accurate project duration.