

## CHAPTER II

### NOMINAL MODIFICATION ACCORDING TO STRUCTURAL GRAMMAR

Structural grammar by definition looks at a language as it really is, not as it should be according to the rules of proper usage as defined by traditional grammarians. Some of the most influential figures of structural linguistics are Bloomfield, Fries, Pike, Francis, Sledd, Hill, Hockett, Gleason, and Trager and Smith. They describe languages from the point of view of an objective observer, noting how the language is employed in reality, unprejudiced by notions of propriety. To our understanding of English, structural grammar appears to be more thorough than the traditional ones. For example, it replaces the vague notional definitions of parts-of-speech by very precise definitions of word classes.

In The Structure of English (1952)<sup>5</sup> Charles C. Fries gives a definition of a noun modifier as the part of the construction that narrows down the meaning of the headnoun but does not change the relation of the headword to the rest of the basic patterns. Nominal modifier here is explained as a functioning unit. It is not only one kind of word as in simplistic school grammar, but all the sorts of words which can occur as noun modifiers. Fries tries to explain what each nominal construction is composed of, including

---

<sup>5</sup> Charles C. Fries, The Structure of English. (Harcourt, Brace and Company, Inc., 1952) pp. 202-227.

the meaning it conveys. He says that the structure of modification is just the relationship between a noun and other kinds of words. Modification is a structure of connection, and he tries to characterize features of the particular way of connection of modifiers to the headnoun.

The position of modifying words, according to Fries, is very important. The most significant position of the noun modifier is between the determiner and the headnoun, e.g., an old man. Another position is the position immediately after the headnoun, e.g., the man in the room. Eighty percent of the single-word noun modifiers in Fries' recorded spoken English material occur in the first type of positioning. Fries explains various types of words and groups of words that can occur in the position of noun modifiers as follows:

1. Class 2 words (Words occurring in the position of verbs that end with -ing or -ed forms) as noun modifiers

a barking dog                    (The noun represents the "performer  
the burning fire                    of the action" indicated in the  
"modifier")

a sealed envelope                (The noun represents the "undergoer  
the dismissed employee                of the action" indicated in  
the "modifier")

2. Class 3 words (Words occurring in the position of adjective) as noun modifiers

an excellent address

the coastal plain (The meaning is that of quality")

a longer vacation

a continuous worker (The meaning is that of "manner of action" because the noun is derived from a Class 2 word)

a perfect stranger (The meaning is that of "degree of substance" because the noun is derived from a Class 3 word)

3. Class 1 word (Words occurring in the position of noun modifiers)

a bath robe

a lady's handkerchief (The meaning is that of

the health service "identification")

Wednesday evening

a truck driver (The class 1 word head derived

the milk delivery from class 2 words; the meaning is that of "undergoer of action")

4. Class 4 words (Word occurring in the position of adverb)

as noun modifiers

the work thereafter

his study abroad

the discussion afterward

5. A word-group having a function word of Group F (so-called "preposition") as noun modifier

a period of being away

(The meaning is that of

a luncheon at twelve-thirty

"identification")

the examination in the morning

6. An included sentence usually with one of the function words of Group F (who, which, that, etc.)

the man who came early

(The meaning is that of

the day after you left

"identification" or des-

the time when you can do it best

cription")

Many structuralists prefer to use the traditional terms in their explanation of word classes rather than the numbers and letters Fries uses.

Various types of noun modifiers are explained by structuralists as consisting of two main forms: modifiers before the noun and modifiers after the noun (prenominal and postnominal modifiers).

The modifiers that come before the headnoun mostly are determiners, adjectives, single verbs in present or past participle form, and nouns.

The modifiers that come after the headnoun are adverbs (mostly adverbs of place and time), prepositional phrases, verb phrases, and relative or subordinating clauses.

### 1. Determiners as Noun Modifiers

Bloomfield (1933)<sup>6</sup> classifies noun determiners as a kind of adjective called a limiting adjective. The position is before a noun. The meaning is that of identification, number, or quality. Many words are classified as noun determiners. Common types of determiners are:

articles: a man, an orange, the house

possessive adjectives: my house, his shoes

Some people also classify the noun possessive (John's house) in this group because it can be substituted for the "my house" position. Other people, for example Francis, classify it in the group of nouns that act as modifiers of another noun.

demonstratives: this man, those girls

others: any, either, every, neither, no, one, some, what, which, whichever, all, both, few, much, four, twenty, thirty-one, more, each.

Sledd in A Short Introduction to English Grammar (1959)<sup>7</sup> explains that the determiner provides a center for a helpful outline: all the nominal phrases which we are first to consider

---

<sup>6</sup> Leonard Bloomfield, Language. (Henry Holt and Company, Inc., 1933) pp. 184 - 206.

<sup>7</sup> James Sledd, A Short Introduction to English Syntax. (Scott, Foresman and Company, 1959) p. 115.

fit into the pattern,

Predeterminer / Determiner / Postdeterminer / Noun,

which is represented by the phrase

all / the / good / men

The predeterminers are words that come before determiners.

The predeterminers are rather various but limited in number.

Examples are:

many a man, such a man, what a man

all the men, both the men

almost all the men, nearly all the men

not quite all the men

The postdeterminers according to Sledd are adjectival (any words that can occur in the adjective position) in that they can stand under second stress before a following noun which has strongest stress, and their relative order is fixed.

The order of modifiers before noun may be stated more fully as

1. predeterminer,
2. determiner,
3. limiting adjective,
4. adverbial of degree,
5. descriptive adjectival,
6. noun adjunct,
7. nominal (here a noun).

1      2      3      4      5      6      7  
all / the / seven / very / fine / stone / walls

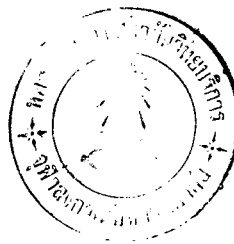

## 2. Adjectives as Noun Modifiers

In general an adjective comes before the headnoun and after the determiner, and the meaning is that of quality of substance.

a <u>small</u> house	his <u>intense</u> concentration
his <u>dirty</u> hands	<u>handsome</u> lad
<u>serious</u> troubles	a <u>longer</u> vacation
<u>greedy</u> pigs	both <u>remarkable</u> tales
the <u>gloomy</u> room	these <u>ripe</u> tomatoes
the <u>coastal</u> plain	

Some people classify numbers as this type of modifier.

Sledd calls numbers limiting adjectives: the two students.

According to Francis (1956)<sup>8</sup>, the adjectives modifying nominals can sometimes have special meaning. If the noun itself is derived from a verb, the meaning is that of "manner of action".

a continuous worker  
a hard student  
a rapid performance

If the headnoun is derived from an adjective the meaning is that of "degree of quality".

a perfect stranger

---

<sup>8</sup> Nelson W. Francis, The Structure of American English.  
(The Ronald Press Company, 1959) pp. 297-312.

utter darkness

an absolute necessity

If the adjective has the same form as when it is a noun, like the word Spanish, the meaning is ambiguous as to whether the modifier functions as adjective or noun.

these Spanish students (those who study the language, Spanish, or students from Spain)

a deaf and dumb teacher (one who teaches those who are deaf and dumb or one who is himself deaf and dumb)

There may be more than one adjective in a nominal construction.

007028

a foclish old dog

It often happens that the adjective itself is in turn, modified by different types of words,

The intensifier is the most common type of modifier of an adjective.

a very good man

a quite correct answer

Adverbs may modify the adjective in a nominal construction.

the widely famous singer

Nouns may modify the adjective.

stone cold coffee

sea green cloth



Verbs may modify the adjective.

the freezing cold water.

the boiling hot water.

a hard to get success.

An adjective itself can modify an adjective in the nominal construction.

icy cold water

deathly pale color

dark blue color

The prepositional phrase (and infinitive) can sometimes modify an adjective in the nominal construction.

an easy on the eyes problem.

a good for nothing idea.

a man easy to talk to

a book interesting to scholars

a place distant from civilization

Most adjectives come before the headnoun but sometimes they come after the headnoun.

- a) in certain fixed phrases, often from technical vocabularies or familiar quotations.

court martial

darkness visible

fee simple

b) when the adjective is a part of larger construction.

a figure vague and shadowy

a man taller than I thought

### 3. Nouns as Nominal Modifiers

Noun attributives always come before the headnoun. The general meaning is that of "identification".

a <u>bath</u> robe	<u>Wednesday</u> evening (evening is
a <u>father</u> image	the head)
the <u>health</u> service	a <u>nerve</u> specialist
<u>Christmas</u> day	a <u>grocery</u> lad
that <u>woman</u> doctor	a <u>school</u> principal
<u>child</u> psychology.	

Francis (1958)<sup>9</sup> also classifies the possessive noun construction in this group, while some people, for example, Bloomfield, don't.

Child's play

my father's house

that woman's doctor

The meaning of the noun attributive to the construction

---

<sup>9</sup> Francis, Ibid., p. 299.

might change from "identification" to "undergoer of action", if the headnoun is derived from a verb.

a truck driver

the milk delivery

The noun attributive can be distinguished from the adjective by adding the intensifiers. The intensifiers can be added to the adjective but not to the noun. For example, we can say a very small house but we can't say \*a very town house.

If the adjective and the noun attributive appear in the same nominal construction, the adjective always comes before the noun.

the small town house

an industrious paper boy

that new beautiful alley cat

### Compound Nouns

Bloomfield (1933)<sup>10</sup> points out that the construction of compound words is most similar to the construction of noun phrases especially when one noun modifies another noun. For example, blackbird (a compound noun) and black bird (a noun-adjective phrase) are different in both meaning and intonation. The compound

---

<sup>10</sup> Bloomfield, loc. cit.

word blackbird gets the strong stress on the first syllable of the construction, which is the syllable black, the other syllable being reduced, and it means a bird of a particular species. But as for the nominal phrase, the word bird gets the strong stress,

The following are other examples of compound words.

door-knob (a kind of knob)

Frenchman

ice cream

blue-eyed girl

bedroom

apple-pie



For the compound blackbird we can substitute the compound bluebird and redbird, as well as single-word nouns.

What you saw was a blackbird.

bluebird.

redbird.

sparrow.

robin.

On the other hand, for black in the phrase black bird we can readily substitute any other color name which applies to a given bird.

What we saw was a black bird.

white

green

red

Besides, the descriptive adjective black in the phrase can be modified by the intensifier very or rather: very black bird, rather black bird, while very can't modify a compound noun. We can, however, expand the adjective black in the phrase with the inflectional suffixes - er and - est: blacker bird, blackest bird, but the compound blackbird does not yield to this kind of expansion.

We should note that the writing of compounds varies considerably. The phrase black bird is written as two words, whereas the compound blackbird is written as only one. But we find that a very large number of compounds are actually written as two words.

### Appositives

An appositive is a special type of noun working as a modifier of the headnoun. It modifies and follows the headnoun. It is always marked by a single-bar juncture in intonation (that is, by a brief pause) before and after.

His brother, / a doctor, / was there.

Mr. Jones, / the art critic, / praised the painting.

The children, / both boys and girls, / received presents.

If the single-bar juncture before and after the appositive do not appear, it is called a "close appositive".

the poet Chaucer

the disease poliomyelitis

the product cellophane

The "close appositive" looks very much like the noun attributive (noun-adjunct) but the two are different. The first type of modifier comes after the headnoun but the second type comes before. In speech we can distinguish one from the other by the stress. The modifier is always marked by stronger stress.

the product cellophane (appositive)  
product control (noun-adjunct)

There is another type of appositive where the headnoun is a personal or geographical title and the noun in apposition is a proper noun. The difference between this type of appositive and the "close appositive" is merely that of meaning.

Professor Jones  
 Vice-President Smith  
 the River Duddon

#### 4. Verbs as Nominal Modifiers

Francis (1958)<sup>11</sup> clearly explains the verb as modifier.

1. If a verb of { -ing } inflection type appears as a nominal modifier, the headnoun will represent the "performer of action" indicated in the "modifier".

a purring cat                      the shrieking aunt

---

<sup>11</sup> Francis, op. cit., pp. 303 - 304.

a singing seaman      a fighling nan  
 a barking dog      running water  
helping hands

Usually this type of modifier precedes the headnoun but sometimes it can follow when it is a part of a larger construction.

water running in the street

The players reporting were all veterans.

2. If a verb of { -ed } inflection type appears as a nominal modifier, the headnoun will represent "the undergoer of the action" indicated in the "modifier".

a sealed envelope      our invited guest  
 the dismissed employee      the insulted mother  
 a stunned cat      baked potatoes  
 this broken bottle

This type of modifier follows the headnoun when it is a part of larger structure.

potatoes baked slowly

If the verbs working as nominal modifiers and the noun attributives occur in the same construction, the verbs will always come first.

purring alley cat  
cemented wall board

Words that end with { -ing } or { -ed } are not always verbs; sometimes they are adjectives or nouns. If they are adjectives,

intensifiers can be added as in a very interesting alley cat or a rather dilapidated wall, but there are no constructions like \*a very purring alley cat or \*a rather cemented wall.

In the following constructions we can see clearly the verb, adjective, and noun with { - ing } ending. They have the same form but different meanings.

- |                         |   |
|-------------------------|---|
| a <u>pleasing</u> table | <u>pleasing</u> here is an adjective.<br>It means a table that is pleasing;<br>"very" can be put in front of it.                                  |
| a <u>rotting</u> table  | <u>rotting</u> is a verb.<br>It means a table that is in the<br>process of rotting; "rotting" can<br>be moved to the place after the<br>headnoun. |
| a <u>dining</u> table   | <u>dining</u> is a noun.<br>It means "a table for dining".<br>Dining cannot be moved nor added to.  |

As for the constructions like a dancing girl, a trotting horse, a racing yacht, or a fighting man, prosody plays an important role in distinguishing the idea. Primary stress on horse identifies trotting as a verb. The noun phrase means "a horse in the process of trotting". However, stronger stress on trotting changes the meaning to "a horse that runs races in which the horses



are allowed only to trot" the same kinds of relationship hold true for the other examples.

If the verbs in marked infinitive form appear as nominal modifiers, they will follow the headnoun.

a time to laugh

money to burn

a man to see

#### 5. Adverbs as Nominal Modifiers

(especially the then and there classes of adverbs which give time and place meaning)

The position of the modifying adverb is generally immediately after the headnoun.

the people there

the temperature outside

heavens above

Europe now

The discussion afterwards

the work thereafter

his study abroad

inside man or man inside

outside man or man outside

## 6. Prepositional Phrases as Nominal Modifiers.

The prepositional phrase consists of a preposition and its object. The object can be an ordinary noun with or without a determiner, a pronoun, a function noun (any word that acts as a noun), or a structure of modification with a noun as head. The meaning of this type of modifier is that of "identification"

a period of being a way  
 a way of doing  
 a day for peacefully resting  
 a luncheon at twelve - thirty  
 a man in the truck  
 the pipe underwater  
 the conversation after dinner  
 the noise like a thunderbolt  
 a time for us  
 a mile from here  
 a time up to now  
 a letter from abroad

The object of a prepositional phrase may itself be a prepositional phrase as in:

a book from under the table  
 a table for after dinner  
 a trip to beyond the mountain

Francis<sup>12</sup> explains the structure of nominal modification with a noun as head and a prepositional phrase with more than one preposition as modifier in the following way.

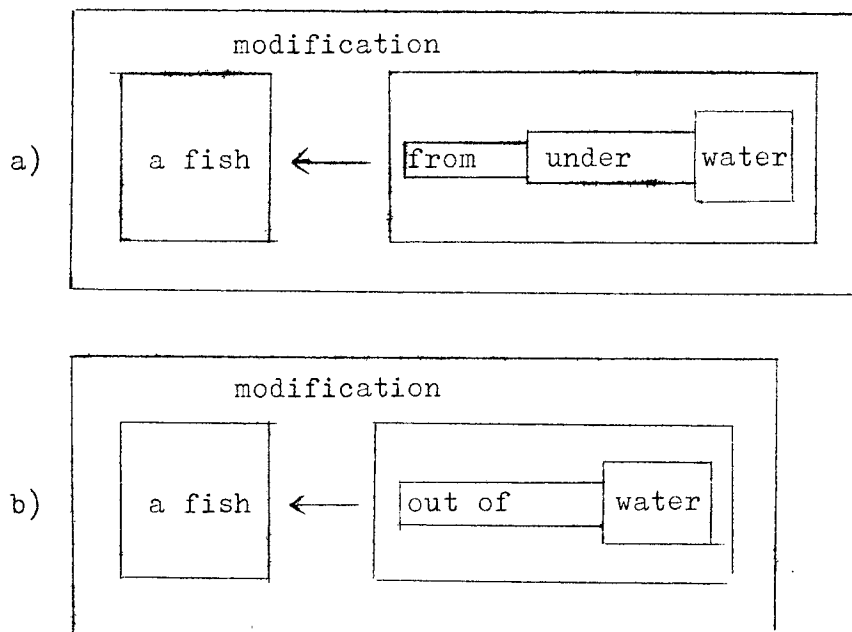

In (b) water is the object of out of, while in (a) water is the object of under, and the whole phrase under water is the object of from. The first expression has one more layer of structure than the second. As can be seen by counting the number of "Chinese boxes" we must put within another to complete the analysis.

---

<sup>12</sup> Francis, Ibid., pp. 310 - 311.



Sometimes the relative word (includer) does not appear in the clause. This can happen when the headnoun appears as an object of the verb of the included clause. The omission of the relative word is shown here by the "zero" sign ( $\emptyset$ ).

the reasons  $\emptyset$  he gave  
 the man  $\emptyset$  we knew  
 the letter  $\emptyset$  somebody sent  
 a mouse  $\emptyset$  the cat dragged in  
 a place  $\emptyset$  he goes in summer  
 a story  $\emptyset$  I heard today  
 the man  $\emptyset$  he told his story to

Another type of included clause is called the "infinitive clause". It contains a relative pronoun and an infinitive:

a quiet place in which to ask

When the prepositional phrase and relative clause both modify the same headnoun, the prepositional phrase always comes before the relative clause.

The man at the back who was smiling

Some friends from Toledo who were wealthy

Some constructions contain various types of nominal modifiers at the same time. The order is as in the following.

- The genial    milk    inspector    on my right    who was smoking a pipe  
 det / adj / noun adjunct / headnoun / prep.phrase / relative clause

- the      mason's                      two                      very      fine      stone      walls  
 det/possessive noun/limiting adj/adv intensifier/adj/n.adjunct/headnoun
- the      high      birth                      rate      in America      today  
 det / adj / n-adjunct / headnoun / prep.phrase / adv.

The structural linguists use the immediate constituent technique to describe a structure of modification. The immediate constituent technique is applied on the assumption that most structures of modification consist of two parts: the head noun and the modifier. Leonard Bloomfield's Language,<sup>13</sup> which is considered to be one of the standard works of linguistic science, presents a theory which was followed by the structuralists. This theory suggests that every syntactic structure has at least two free forms combined in a phrase.

John<sup>1</sup>      rān<sup>2</sup>

poor<sup>1</sup>      John<sup>2</sup>

The structure of nominal modification is explained as a subordinative endocentric construction. That is, the whole construction belongs to the same form class of one (or more) of the constituents which is the center or head of the construction.

In the phrase poor John, John is the head of the construction. It contains the noun expression. Poor is the attributive

---

<sup>13</sup> Bloomfield, loc. cit.

(modifier) of the head. It contains an adjective expression.

The construction poor John has the same function as John. It is called a character substance construction.

The important notion about levels of structure is that a construction is made of two parts (immediate constituents) each part of which is made of two parts, and so on, until the ultimate constituent is reached.

In the phrase This very fresh milk, This is a modifier of very fresh milk. Very is a modifier of fresh milk. Fresh is a modifier of milk. Milk is the head of the construction and the ultimate constituent (head).

Inside this character-substance construction there is a feature of order. The adjective expression precedes and modifies the noun expression.

The limiting adjectives (determiners and numeratives) precede and modify the descriptive adjective plus noun.

These seven new toys

There is also order in the descriptive adjective phrase whose meaning is that of qualitative character.

big black sheep

kind old man

The black sheep is big. Thus the blackness of the sheep is more central to the characteristics of the sheep than its size as expressed in the word big.

Immediate Constituent Diagrams

There are a number of methods of diagramming structures according to their immediate constituents. The simplest and most generally useful is that known as the tree diagram, used by Nida and Gleason<sup>14</sup>.

The three old ladies upstairs own a boxer dog with a mean temper

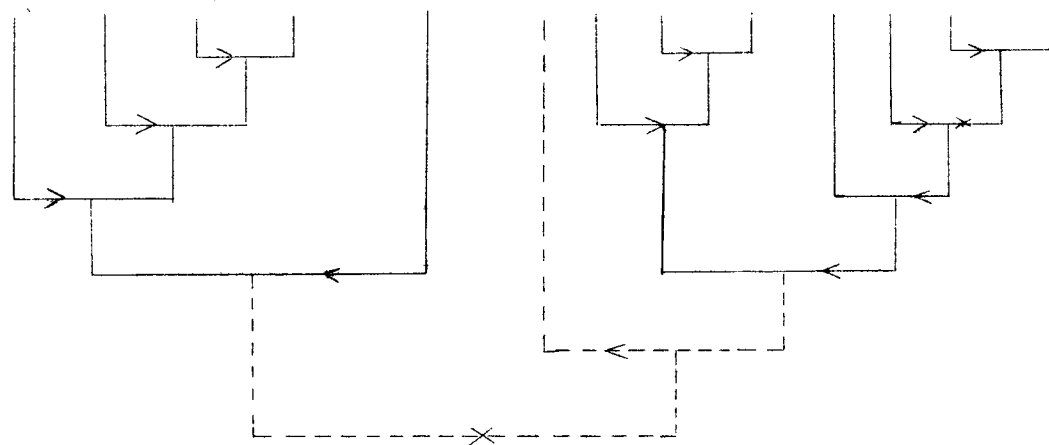

The modifier - head construction is marked by an arrow pointing toward the head.

adjective    noun  
 └───┬───┘  
       →

article    noun  
 └───┬───┘  
       →

noun    phrase  
 └───┬───┘  
       ←

noun    adverb  
 └───┬───┘  
       ←

---

<sup>14</sup> Gleason, op. cit., pp. 151 - 152.



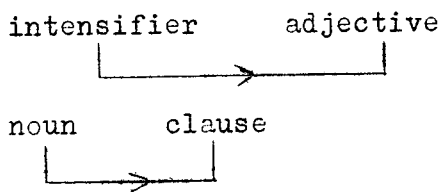

The three old ladies upstairs own a boxer dog with a mean temper

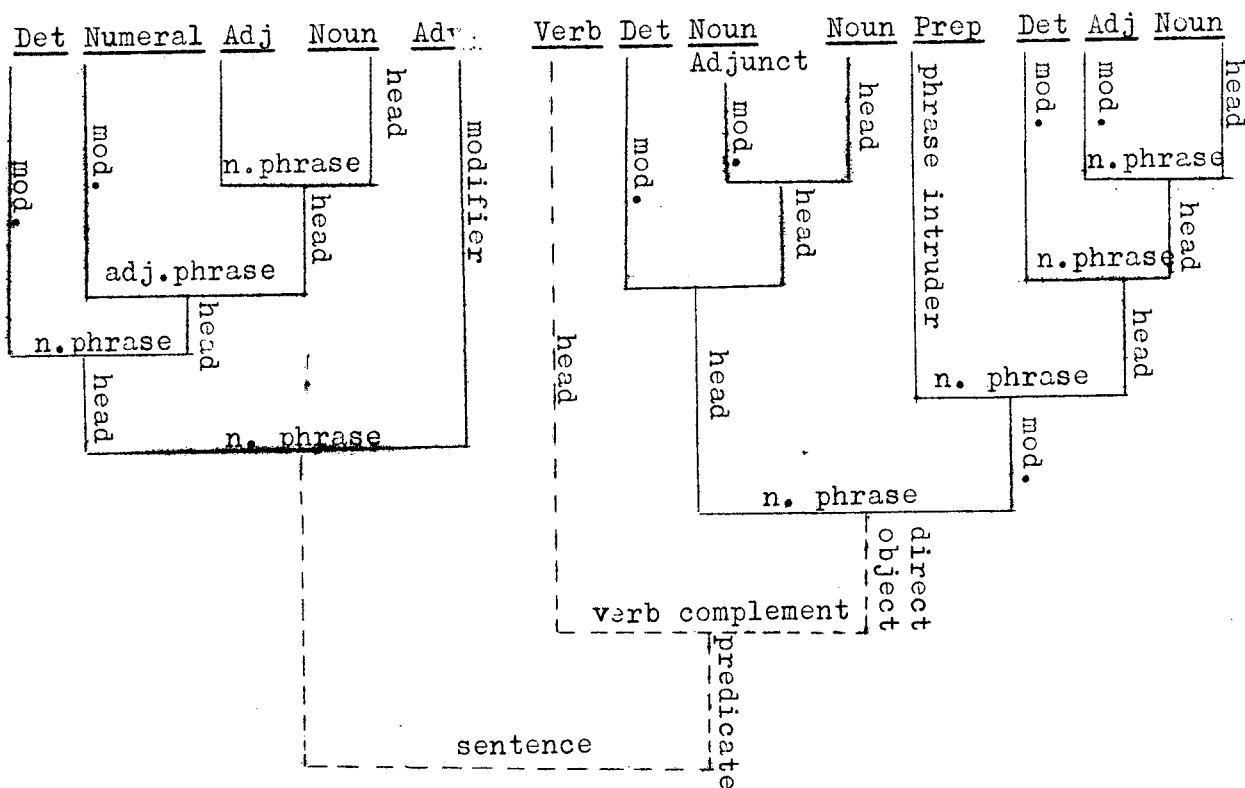

The following are examples of diagramming nominal construction by Nida (1966)<sup>15</sup>



<sup>15</sup> Eugene A. Nida, A Synopsis of English Syntax. Second revised edition. (Mouton & Co., The Hague, The Netherlands, 1966)

(a) floating stick (verb-ing + noun)

(a) lovely and gracious personality (adj and adj + noun)

(a) pretty young woman (adj + adj + noun)

(the) university chemistry club (noun + noun + noun)

(a) very fine dress (intensifier (adv) + adj + noun)

(a) rather recently published article (intensifier (adv) + adv + verb-ed + noun)

Jack's affair (noun possessive + noun)

almost all the chiefs (predet + det + noun)

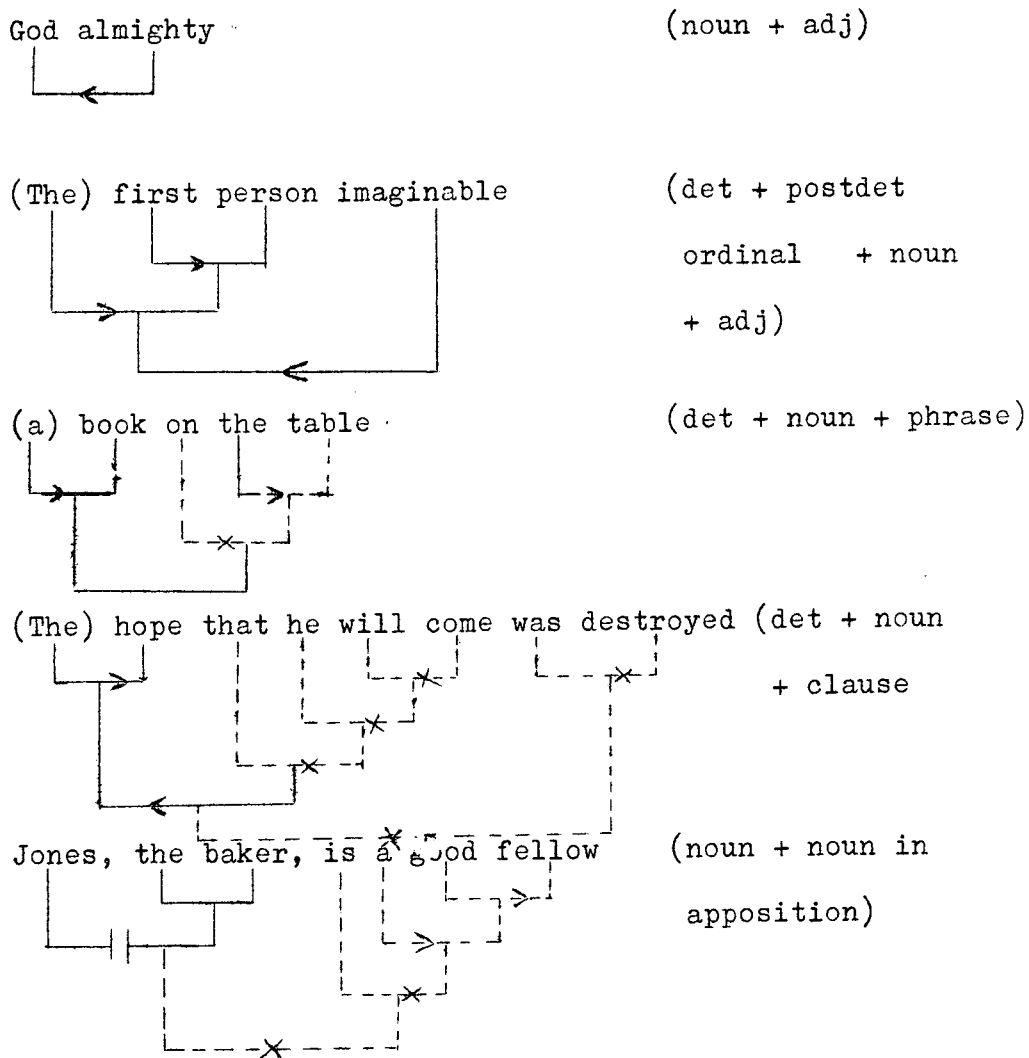

Fries<sup>16</sup> uses the line to explain the immediate constituents of a phrase.

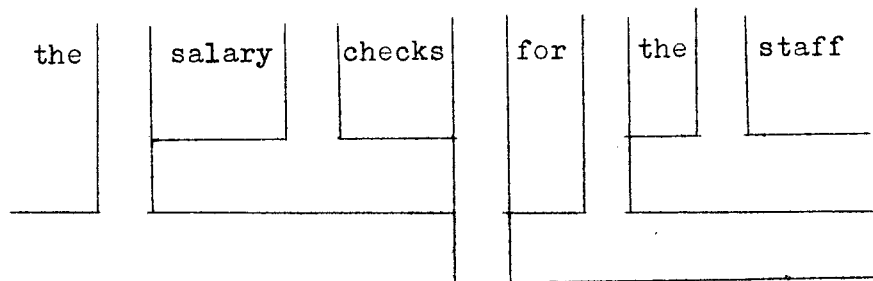

<sup>16</sup> Fries, op. cit., p. 272.

Francis' "Chinese boxes"<sup>17</sup> can show clearly the series of structures of nominal modification one within the other. For the modifier-head construction, the arrow points toward the head.

For example, 

good
------

 → 

man
-----

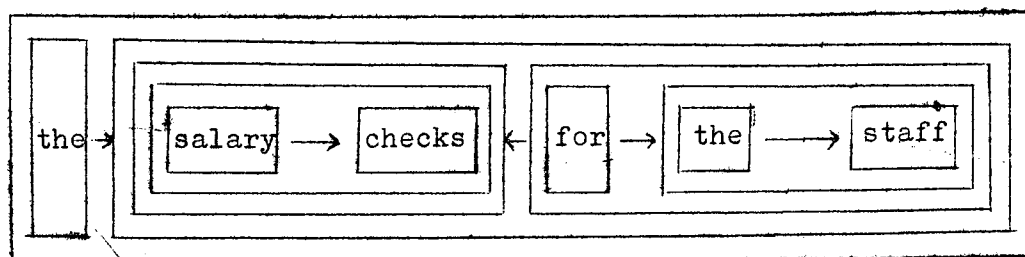
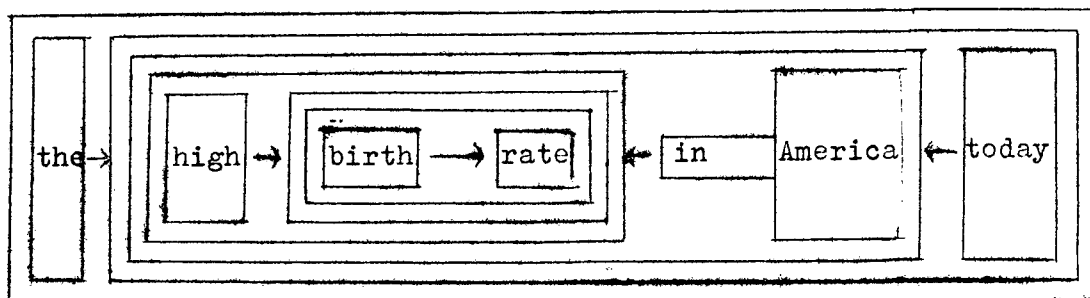

Note the discrepancy in the relationship between the and the remainder of the phrase as shown by Francis and that of Fries above.

There are many techniques that are used to illustrate the various levels of the relationship of words in a nominal construction. Francis's Chinese boxes are quite good at showing relationships, but it is not easy to draw the boxes.

---

<sup>17</sup> Francis, op. cit., p. 312.

Hockett<sup>18</sup> used another different form of diagram to explain the relationships of immediate constituents.

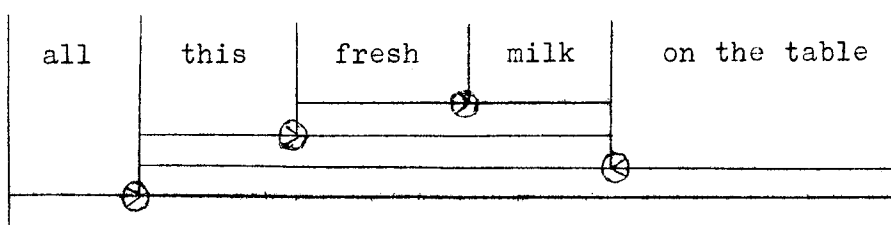

The marks " > " and " < " are placed at the junctions of immediate constituents, and point from the attributes towards the head.

The techniques used by structural grammarians to describe English nominal modification are rather clear. We can see how each construction is composed of a string of words. But there may be structural ambiguity which results from the structure itself of an utterance, and lexical ambiguity or the multiple meanings that reside in the words themselves, which structural techniques do not clarify.

The following are examples of structural ambiguities that Norman C. Stageberg points out in his article called Some Structural Ambiguities<sup>19</sup>.

---

<sup>18</sup> Charles F. Hockett, A Course in Modern Linguistics, (The Macmillan Company, 1959) p. 188.

<sup>19</sup> Norman C. Stageberg, "Some Structural Ambiguities" Readings in English Linguistics, Edited by Harold B. Allen. (Meredith Publishing Company 1964) pp. 111 - 119.

## 1. Adj + noun in possessive case + noun

A dull boy's knife. The trouble here is that the adjective may modify either the noun in the possessive case or the second noun. It is true that in English we tend to interpret an adjective as modifying everything that follows it up to and including the headword, but despite this tendency we often meet ambiguities like a blond artist's model, a clever reporter's man's necktie. An advertisement in the New Yorker played upon this pattern with this legend: "A handsome man's shirt? No, a man's handsome shirt.

## 2. adj + noun + noun

Little Charm Motel. In this case the adjective may modify the immediately following noun or the second noun. We meet ambiguities of this kind often in such expressions as modern language teaching, big building owners, basic English text, hot evening drink, fresh strawberry ice cream, hot bed covers, heavy box production, and deep love movies.

## 3. Modifier (noun or adjective) + noun

Fleet planes told shoot snoopers jet. What kind of planes do we have here, speedy planes or planes of the fleet? The sentence is ambiguous because we do not know the form class of the modifier fleet.

German teachers visit Greensboro. Would you take this to mean teachers of German or teachers from Germany?

4. More or most + adj + noun. The ambiguity lies in the two possibilities - that more or most may modify the adjective or the noun.

Give me more realistic details.

The defense system should have fewer troops with more modern arms, including field missiles.

Occasionally the words less or least, because of their use in the sense of fewer and fewest, will cause a similar difficulty.

This soap has less harmful effects on the hands.

5. Noun + noun + noun

Study of fish blood system may aid cancer research.

Does the first noun fish modify the compound noun blood system, or does the compound noun fish blood modify system?

Cream cheese cake. Is this cheese cake with cream or cake with cream cheese?

Usually when we meet a collocation of three nouns the sense operates to prevent ambiguity, as in hand garden plow and coil bed springs. When more than three nouns pile up, the result is likely to be confusion, as in this.

New Moscow bus student travel office

6. Adjective + series of nouns

A baseball player must have good vision, coordination,

and speed. Does the adjective good in this sentence modify only vision, or the whole series of nouns? If one insists that it modifies only vision, then what can be said about this sentence, which has exactly the same pattern?

She raised wonderful tulips, hyacinths, and crocuses. Does wonderful here modify only tulips? Thus it seems apparent that the situation itself makes for ambiguity. Of course the lexical compatibility of the words may keep the reading from going wrong. For instance, the first sentence would be clear if the adjective were compatible only with vision.

A baseball player must have sharp vision, coordination, and speed.

#### 7. Noun + series of adjectives.

In the following example of a New York Times advertisement, the words describe three colors in which men's socks are available: heather gray, red, and blue. If one ordered red socks on the basis of this description, what color would he get -- red, or heather red?

#### 8. Modifier + past participle + noun.

In this pattern the question is whether the first term modifies the past participle or the noun.

Steep pointed gables, heavy padded coat, clean swept room.



## 9. -ing verb + noun.

This pattern may sometimes be constructed in two ways:  
as modifier + noun, or as verb + noun object

So you think you have moving problems!

He joined the standing committee.

She maintains an entertaining apartment.

## 10. adj + noun + conjunction + noun.

The question is whether the adjective modifies only  
the first noun or both nouns.

A new company was formed to handle artificial ice and fuel

## 11. Series of words + modifying word or word group.

The series usually consists of nouns. The question  
that arises is whether the modifier refers to all items in the  
series or only to the last item.

A conservative, a Fascist, and an atheist who might  
be excluded from the leading profession because of non-conforming  
beliefs

Red, yellow, blue, navy, or white with trim.

12. Modificand + two modifying word groups (prepositional  
phrases, relative clauses and verbal phrases).

Here the trouble lies in the third term - what does it  
refer to?

a) Modificand + prepositional phrase + relative clause.

In this pattern the writer often intends the relative clause to modify the modificand; but when this clause appears to modify the last word of the preceding phrase, then the sentence is ambiguous. There is no ambiguity, of course, when ties in agreement prevent us from misreading.

The life of a movie star that the public sees  
does look glamorous.

She has cute ideas for parties that are easy to plan.

He has a blue satin ribbon around his neck which  
is tied in a bow at the top.

We have a reputation for fine food, quick service, and  
a friendly atmosphere which amounts to a tradition.

b) Modificand + prepositional phrase + verbal phrase.

There was a spotted dog in the group barking at the  
speeding ear.

c) Modificand + relative clause + prepositional phrase

I was talking about the books I read in the library.

d) Modificand + relative clause + verbal phrase.

We watched the old miner, Maheu, who was feeding his  
horse, begrimed with dust from the mine.

e) Modificand + relative clause + relative clause.

Fred had a second-hand car that he later traded for a motorcycle which he loved to tinker with.

f) Modificand + verbal phrase + relative clause.

There is also a theater located near the business district which is crowded every night.

g) Modificand + verbal phrase + verbal phrase.

I saw the rake lying against the box stuffed with leaves from my last raking.

Fries in his Structure of English points out that if one does not know the form-class, that is the part of speech of a word, then one does not recognize the pattern and as a consequence the word is ambiguous.

German teachers visit Greensboro.

He joins the standing committee.

Traditional grammar resorted to vague semantic notions in order to specify what could qualify as a well-formed expression. The structural linguists, in an effort to avoid such "mentalism" chose to reduce this goal drastically. Thus structuralists claimed on occasion simply to give an account of which sequences of words occur in a particular body of sentences which were examined. Linguistic analysis was then said to succeed simply in providing

a set of elements by means of which one could transcribe sentences as linear sequences of units. Structuralists also claimed that structural science provided, or should have provided, exact procedures for constructing automatically a grammatical analysis for any given presented sentence or for a language as a whole, but with no indications of just what sort of thing a grammatical analysis would have to be. But in any case, the attempt to explain directly the knowledge which the language user has of grammatical well-formedness had been abandoned.

Structural grammar can explain rather clearly how words on the surface of structures of nominal modification are related to one another, but it only explains what are visible connections between words. It is too objective to explain a language thoroughly. It gives no deep explanation of language, but just naively assumes that mere description will provide its own interpretation. There are a lot of invisible things that speakers understand by their intuition. This part of the language, ignored by structuralists in accordance with their theories, is important. This is the weak point of structural grammar. This is why structural grammar is insufficient to explain how a language works.