

MACROSCOPIC, MICROSCOPIC AND MOLECULAR AUTHENTICATION OF SELECTED
GENERA *EURYCOMA*, *ERYTHROXYLUM* AND *TINOSPORA* ENDEMIC TO THAILAND

Mr. Somdet Katib



บทคัดย่อและแฟ้มข้อมูลฉบับเต็มของวิทยานิพนธ์ตั้งแต่ปีการศึกษา 2554 ที่ให้บริการในคลังปัญญาจุฬาฯ (CUIR)
เป็นแฟ้มข้อมูลของนิสิตเจ้าของวิทยานิพนธ์ ที่ส่งผ่านทางบัณฑิตวิทยาลัย

The abstract and full text of theses from the academic year 2011 in Chulalongkorn University Intellectual Repository (CUIR)
are the thesis authors' files submitted through the University Graduate School.

A Dissertation Submitted in Partial Fulfillment of the Requirements
for the Degree of Doctor of Philosophy Program in Public Health Sciences

College of Public Health Sciences

Chulalongkorn University

Academic Year 2016

Copyright of Chulalongkorn University

ลักษณะทางมหรรณู จุลทรรณู และเอกลักษณ์ทางอนุพันธุศาสตร์ ของพืชสกุลปลาไหลเผือก สกุล
โคคา และสกุลบอระเพ็ดบางชนิดในประเทศไทย



วิทยานิพนธ์นี้เป็นส่วนหนึ่งของการศึกษาตามหลักสูตรปริญญาวิทยาศาสตรดุษฎีบัณฑิต

สาขาวิชาวิทยาศาสตร์สาธารณสุข

วิทยาลัยวิทยาศาสตร์สาธารณสุข จุฬาลงกรณ์มหาวิทยาลัย

ปีการศึกษา 2559

ลิขสิทธิ์ของจุฬาลงกรณ์มหาวิทยาลัย

.....External Examiner

(Associate Professor Worapan Sitthithaworn, Ph.D.)



สมเด็จพระเทพรัตนราชสุดาฯ สยามบรมราชกุมารี : ลักษณะทางมหัพภวิทยา จุลภัพภวิทยา และเอกลักษณ์ทางอนุพันธุศาสตร์ ของพืชสกุลปลาไหลเผือก สกุลโคคา และสกุลบอระเพ็ดบางชนิดในประเทศไทย (MACROSCOPIC, MICROSCOPIC AND MOLECULAR AUTHENTICATION OF SELECTED GENERA *EURYCOMA*, *ERYTHROXYLUM* AND *TINOSPORA* ENDEMIC TO THAILAND) อ.ที่ปรึกษาวิทยานิพนธ์หลัก: ผศ. ดร. กาญจนา รังษีหิรัญรัตน์, อ.ที่ปรึกษาวิทยานิพนธ์ร่วม: รศ. ดร. นิจศิริ เรืองรังษี, ดร. ปิยรัชฎ์ ปริญาพงษ์ เจริญทรัพย์, 112 หน้า.

พืชสกุล *Eurycoma* สกุล *Erythroxylum* และสกุล *Tinospora* เป็นพืชสมุนไพรที่ถูกนำมาใช้อย่างกว้างขวางมาเป็นเวลานานตามฤทธิ์ทางเภสัชวิทยาที่ใช้เป็นยาแก้ไข้ เนื่องจากลักษณะทางพฤกษศาสตร์ของพืชสกุลเหล่านี้มีความคล้ายคลึงกัน ทำให้ยากต่อการจำแนกชนิดโดยการใช้เป็นสมุนไพรทดแทนกัน การศึกษาในครั้งนี้จึงมีวัตถุประสงค์เพื่อจำแนกความแตกต่างระหว่างพืชสมุนไพร 3 สกุล ได้แก่ ต้นปลาไหลเผือกและปลาไหลเผือกเล็กในสกุล *Eurycoma* ต้นโคคา ต้นทูนไห้ และต้นไทรทองในสกุล *Erythroxylum* ต้นบอระเพ็ดและต้นชิงช้าชาลีในสกุล *Tinospora* โดยวิธีการตรวจสอบทางมหัพภวิทยา จุลภัพภวิทยา และอนุพันธุศาสตร์ ร่วมกับการกำหนดค่ามาตรฐานของต้นปลาไหลเผือก ซึ่งเป็นพืชสมุนไพรที่มีความสำคัญที่ใช้ในการรักษาโรค การประเมินลักษณะทางพฤกษศาสตร์ และภาพตัดขวางของเส้นกลางใบแสดงในรูปแบบภาพวาดลายเส้นและพรรณนาลักษณะทางพฤกษศาสตร์ ประเมินค่าคงที่ของใบ (จำนวนปากใบ ค่าดัชนีของใบ จำนวนเซลล์ผิว ค่าพื้นที่เซลล์ผิว ค่าอัตราส่วนเซลล์รั้วและชนิดของปากใบ) ภายใต้กล้องจุลทรรศน์วิเคราะห์ลักษณะทางพันธุกรรมด้วยลายพิมพ์ดีเอ็นเอชนิดเอเอฟแอลพี กำหนดค่ามาตรฐานของรากปลาไหลเผือกตามระเบียบวิธีของการควบคุมคุณภาพของพืชสมุนไพรโดยองค์การอนามัยโลก การประเมินภาพตัดขวางของเส้นกลางใบแสดงให้เห็นถึงความแตกต่างของการจัดเรียงตัวของเซลล์พื้นฐานของแต่ละสปีชีส์ การประเมินทางจุลทรรศน์พบปากใบของพืชในสกุล *Eurycoma* และ *Tinospora* เป็นชนิด anomocytic ส่วนสกุล *Erythroxylum* เป็นชนิด paracytic โดยปากใบของทุกต้นจะพบเฉพาะด้านล่างของใบ ยกเว้นต้นชิงช้าชาลีที่พบทั้งด้านบนและด้านล่างของใบ การประเมินค่าคงที่ของใบพบความแตกต่างของค่าคงที่ระหว่างสปีชีส์ในแต่ละสกุลซึ่งสามารถใช้ในการพิสูจน์เอกลักษณ์ของพืชสกุลเหล่านี้ได้ ลายพิมพ์ดีเอ็นเอชนิดเอเอฟแอลพี ที่ได้จากไพรเมอร์ จำนวน 5 คู่ ให้แถบดีเอ็นเอที่มีความคมชัดและจำนวนแตกต่างกัน (348, 349 และ 476 แล็บ) ร้อยละของความแตกต่าง (96.26%, 97.42% และ 96.01%) และค่าสัมประสิทธิ์ความเหมือนทางพันธุกรรม (ระหว่าง 0.331 ถึง 0.957, 0.270 ถึง 0.988 and 0.472 ถึง 0.934) ในพืชสกุล *Eurycoma*, *Erythroxylum* และ *Tinospora* ตามลำดับ การจัดกลุ่มความสัมพันธ์ทางพันธุกรรมด้วยวิธี UPGMA สามารถแยกพืชแต่ละชนิดในสกุลเดียวกันได้อย่างชัดเจน การประเมินข้อกำหนดทางเภสัชวิทยาของรากปลาไหลเผือก พบการเรียงตัวและชนิดของเซลล์ต่างๆที่มีลักษณะเฉพาะ พบปริมาณเถ้ารวม ปริมาณเถ้าที่ไม่ละลายในกรด น้ำหนักที่หายไปเมื่อทำให้แห้ง และปริมาณน้ำ ไม่ควรเกินร้อยละ 1.97, 0.67, 7.52 และ 13.35 โดยน้ำหนักแห้งตามลำดับ ปริมาณสิ่งสกปรกด้วยน้ำและเอทานอล ไม่ควรเกินร้อยละ 4.89 และ 1.73 โดยน้ำหนักแห้งตามลำดับ รวมทั้งรูปแบบทางโครมาโทกราฟีโดยของสารสกัดเมทานอล โดยข้อมูลที่ได้จากการศึกษาวิจัยในครั้งนี้สามารถนำไปประยุกต์ใช้ในการพิสูจน์เอกลักษณ์ของกลุ่มพืชในสกุล *Eurycoma*, *Erythroxylum* และ *Tinospora* และใช้ในการกำหนดค่ามาตรฐานของต้นปลาไหลเผือกได้

สาขาวิชา วิทยาศาสตร์สาธารณสุข

ปีการศึกษา 2559

ลายมือชื่อนิสิต

ลายมือชื่อ อ.ที่ปรึกษาหลัก

ลายมือชื่อ อ.ที่ปรึกษาร่วม

ลายมือชื่อ อ.ที่ปรึกษาร่วม

5279412653 : MAJOR PUBLIC HEALTH SCIENCES

KEYWORDS: MACROSCOPIC / MICROSCOPIC / EURYCOMA / ERYTHROXYLUM / TINOSPORA / AMPLIFIED FRAGMENT LENGTH POLYMORPHISM

SOMDET KATIB: MACROSCOPIC, MICROSCOPIC AND MOLECULAR AUTHENTICATION OF SELECTED GENERA *EURYCOMA*, *ERYTHROXYLUM* AND *TINOSPORA* ENDEMIC TO THAILAND. ADVISOR: ASST. PROF. KANCHANA RUNGSIHIRUNRAT, Ph.D., CO-ADVISOR: ASSOC. PROF. NIJSIRI RUANGRUNGSI, Ph.D., PIYARAT PARINYAPONG CHAREONSAP, Ph.D., 112 pp.

Genera *Eurycoma*, *Erythroxyllum* and *Tinospora* have been widely used as herbal plants for a long time as their pharmacological activities in traditional medicine for antipyretic. Among these three genera, there are some similarity in morphological characteristics which leading to crude drugs substitution. This current study aims to examine the distinguishable characteristics between *Eurycoma longifolia* Jack and *Eurycoma harmandiana* Pierre in genus *Eurycoma*, *Erythroxyllum novogranatense* (Morris) Hieron, *Erythroxyllum cambodianum* Pierre and *Erythroxyllum cuneatum* (Miq.) Kurz in genus *Erythroxyllum*, and *Tinospora crispa* (L.) Miers ex Hook.f.& Thomson and *Tinospora baenzigeri* Forman in genus *Tinospora* using macroscopic examination, microscopic examination and molecular authentication as well as establish the standardization parameter for establish the quantity of *Eurycoma longifolia* Jack due to its essential medicinal plant. Evaluation of macroscopic characteristics and midrib transverse section of leaf were illustrated by drawing, and described as anatomical and botanical characteristics. Leaf constant values (stomata number, stomata index, epidermal cell number, epidermal cell area, palisade ratio and stomatal type) were evaluated under microscope. AFLP DNA fingerprint analysis was also performed for their genetic assessment. Standardization of *Eurycoma longifolia* Jack root were evaluated according to WHO guideline. Midrib transverse section of leaf showed the difference in arrangement of fundamental cells in each species. For microscopic examination, genera *Eurycoma* and *Tinospora* showed anomocytic type of stomata but genus *Erythroxyllum* showed paracytic type of stomata. The stomata existed only on the abaxial in all species except occurred on both sides of adaxial and abaxial in *Tinospora baenzigeri*. Microscopically leaf constant numbers any these species were established and capable to be a tool for authentication. AFLP fingerprinting obtained from five primer combinations produced a total of distinct and highly polymorphic fragments (348, 349 and 476 bands), percentage of polymorphic bands (96.26%, 97.42% and 96.01%) and the similarity index (0.331 - 0.957, 0.270 - 0.988 and 0.472 - 0.934) among selected species in genera *Eurycoma*, *Erythroxyllum* and *Tinospora* respectively. The UPGMA dendrogram was clearly separated individual species into each cluster. Pharmacognostic specification of *Eurycoma longifolia* root were founded unique of arrangement and type of cell components. The standardization parameters of *Eurycoma longifolia* root including total ash, acid insoluble ash, loss on drying and water contents should be not more than 1.97, 0.67, 7.52 and 13.35 while water soluble extractive and ethanol soluble extractive values should be not less than 4.89 and 1.73 of dry weight respectively. Thin layer chromatographic patterns of methanolic extract were also demonstrated. In conclusion, the data obtained from these results provided highly useful information and could be applied for the authentication of selected genera *Eurycoma*, *Erythroxyllum* and *Tinospora*, and established the standardization of *Eurycoma longifolia*.

Field of Study: Public Health Sciences

Academic Year: 2016

Student's Signature

Advisor's Signature

Co-Advisor's Signature

Co-Advisor's Signature

ACKNOWLEDGEMENTS

The author would like to express my grateful thanks to my thesis advisor, Assistant Professor Dr. Kanchana Rungsirunrat, the thesis co-advisor, Associate Professor Dr. Nijsiri Ruangrunsi and Dr. Piyarat Parinyapong Chareonsap. I am very grateful to them for their times, useful guidance, valuable suggestion and encouragement throughout the study until my work have been successfully completed.

I would like to thank the chairman of thesis committee, Professor Surasak Taneepanichskul, M.D., and the thesis committee, Assistant Professor Dr. Chanida Palanuvej, Dr. Tepanata Pumpaibool and Associate Professor Dr. Worapan Sitthithaworn for their critical perusal, constructive suggestion and valuable advice.

I would like to thank Assistant Professor Dr. Chanida Palanuvej and Dr. Onuma Zongrum, College of Public Health Sciences, Chulalongkorn University, for her encouragement, valuable suggestion and helping throughout my work.

I would like to thank Mr. Niran Wipunngern, Faculty of Pharmacy, Rungsit University for suggestion and kind assistance in part of macroscopic and microscopic identification and drawing techniques.

I would like to thank Associate Professor Dr. Suchada Sukrong and Mr. Worathat Thitikornpong, Drug and Health Products Innovation Promotion Center, Faculty of Pharmaceutical Sciences, Chulalongkorn University, for teaching and valuable suggestion in part of DNA fingerprinting throughout this study.

I would like to acknowledge the scholarly supported by the scholarships for the Ph.D. programme, Mae Fah Luang University and the 90th Anniversary of Chulalongkorn University Fund (Ratchadaphiseksomphot Endowment Fund).

I would like to thanks College of Public Health Sciences, Chulalongkorn University and Plant Genetic Conservation Project under The Royal Initiation of Her Royal Highness Princess Maha Chackri Sirindhorn (RSPG), Chitralada Palace, Dusit, Bangkok, Thailand and all staff members for providing research facilities support and their kindness assistance in the AFLP techniques throughout this study.

Most of all, I would like to thankful all staff members and my colleague in College of Public Sciences, Chulalongkorn University for kindness and friendship throughout this study.

Most importantly, I would like to thank my family for their warmth, supporting, understanding and encouragement throughout my thesis and I have been in love and concentration from them always.

CONTENTS

	Page
THAI ABSTRACT	iv
ENGLISH ABSTRACT	v
ACKNOWLEDGEMENTS	vi
CONTENTS	vii
LIST OF TABLES	xii
LIST OF FIGURES	xiv
CHAPTER I INTRODUCTION.....	1
1. Background and rationale.....	1
2. Research questions	3
3. Objectives	3
4. Benefits and applications.....	4
5. Conceptual framework.....	5
CHAPTER II LITERATURE REVIEW	1
2.1 Plant samples in genus <i>Eurycoma</i>	1
2.2 Plant samples in genus <i>Erythroxylum</i>	7
2.2.1 <i>Erythroxylum novogranatense</i> (Morris) Hieron.....	8
2.2.2 <i>Erythroxylum cambodianum</i> Pierre.....	11
2.3 Plant samples in genus <i>Tinospora</i>	15
2.3.1 <i>Tinospora crispa</i> (L.) Miers ex Hook.f.& Thomson	15
2.3.2 <i>Tinospora baenzigeri</i> Forman	17
2.4 Medicinal plant identification	19
2.4.1. Pharmacognostic specification	20

	Page
2.4.1.1 Macroscopic examination	20
2.4.1.2 Microscopic anatomical examination	20
2.4.1.3 Microscopic measurement	21
2.4.1.3.1 Stomatal type	21
2.4.1.3.2 Stomatal number	22
2.4.1.3.3 Stomatal index	22
2.4.1.3.4 Palisade ratio	23
2.4.1.4 Standardization parameters	23
2.4.1.4.1 Determination of total ash	23
2.4.1.4.2. Determination of acid-insoluble ash	24
2.4.1.4.3. Determination of solvent extractive values	24
2.4.1.4.4. Determination of loss on drying	24
2.4.1.4.5. Determination of water content	24
2.4.1.4.6. Thin-layer chromatography (TLC) identification	25
2.4.2. Molecular authentication	25
2.4.2.1 DNA isolation	26
2.4.2.2 DNA quantification and quality assessment	26
2.4.2.3 Polymerase Chain Reaction (PCR)	27
2.4.2.4 Amplified fragment length polymorphism (AFLP)	28
CHAPTER III MATERIAL AND METHODS	32
3.1 Macroscopic examination	32
3.1.1 Plant samples	32
3.1.2 Morphological characteristics	32

	Page
3.2 Microscopic Examination	33
3.2.1 Preparation of plant samples.....	33
3.2.2 Anatomical character	33
3.2.2.1 Transverse section of leaves.....	33
3.2.3 Leaf measurement	34
3.2.3.1 Stomatal types.....	34
3.2.3.2 Stomatal number	34
3.2.3.3 Stomatal index.....	34
3.2.3.4 Palisade ratio	35
3.2.3.5 Epidermal cell number	35
3.2.3.6 Epidermal cell area.....	35
3.3 Molecular evaluation.....	36
3.3.1 Plant materials	36
3.3.2 Genomic DNA Extraction	37
3.3.3 AFLP Procedure.....	38
3.3.3.1 Digestion of genomic DNA	38
3.3.3.2 Ligation of genomic DNA.....	39
3.3.3.3 Preselective amplification.....	40
3.3.3.4 Selective amplification	41
3.3.3.5 Detection of AFLP band patterns.....	43
3.3.3.5.1 Denaturing Polyacrylamide gel electrophoresis	43
3.3.3.5.2 Silver staining	43
3.3.3.6 Data analysis.....	43

	Page
3.4 Standardization parameters of <i>Eurycoma longifolia</i> root crude drug	44
3.4.1 Macroscopic examination.....	44
3.4.2 Microscopic examination.....	44
3.4.3 Physiochemical parameters.....	44
3.4.3.1 Determination of total ash	45
3.4.3.2 Determination of acid-insoluble ash	45
3.4.3.3 Determination of ethanol-soluble extractive	45
3.4.3.4 Determination of water-soluble extractive	45
3.4.3.5 Determination of loss on drying.....	46
3.4.3.6 Determination of water content	46
3.4.3.7 Thin-layer chromatographic identification.....	46
CHAPTER IV RESULTS	47
4.1 Macroscopic evaluation	47
4.1.1 Morphological characteristics	47
4.2 Microscopic evaluation	59
4.2.1 Anatomical character	59
4.2.1.1 Transverse section of leaf of two <i>Eurycoma</i> species.....	59
4.2.1.2 Transverse section of leaf of three <i>Erythroxylum</i> species.....	62
4.2.1.3 Transverse section of leaf of two <i>Tinospora</i> species.....	65
4.2.2 Microscopic measurement.....	67
4.2.2.1 Leaf measurement of two <i>Eurycoma</i> species.....	67
4.2.2.2 Leaf measurement of three <i>Erythroxylum</i> species.....	68
4.2.3 Type of stomata.....	70

	Page
4.2.2.1 Stomatal type of two Eurycoma species	70
4.2.2.2 Stomatal type of three Erythroxyllum species	71
4.2.2.3 Stomatal type of two Tinospora species.....	72
4.3 Molecular evaluation.....	73
4.3.1 DNA extraction.....	73
4.3.2 AFLP analysis	73
4.3.2.1 AFLP analysis of two Eurycoma species.....	73
4.3.2.2 AFLP analysis of three Erythroxyllum species.....	76
4.4 Standardization of <i>Eurycoma longifolia</i> Jack root	83
4.4.1 Macroscopic examination.....	83
4.4.2 Microscopic examination.....	85
4.4.2.1 Anatomical character.....	85
4.4.2.2 Histological character	87
4.4.3 Physicochemical parameters.....	88
4.4.4 TLC fingerprint	89
REFERENCES	96
VITA.....	112

LIST OF TABLES

Table 3.1 Preparation of reaction mixture for digesting genomic DNA.....	38
Table 3.2 Reaction mixture for ligation of <i>Eco</i> RI and <i>Mse</i> I adapters.....	39
Table 3.3 Sequences of adapters and primers used for AFLP analysis	40
Table 3.4 Reaction mixture for preselective amplification reaction.....	41
Table 3.5 Reaction mixture for selective amplification reaction.....	42
Table 4.1 Morphological characteristics of <i>Eurycoma longifolia</i> and <i>Eurycoma harmandiana</i>	51
Table 4.2 Morphological characteristics of <i>Erythroxylum novogranatense</i> , <i>Erythroxylum cambodianum</i> and <i>Erythroxylum cuneatum</i>	55
Table 4.3 Morphological characteristics of <i>Tinospora crispa</i> and <i>Tinospora baenzigeri</i>	58
Table 4.4 Leaf constant number of <i>Eurycoma longifolia</i> and <i>Eurycoma harmandiana</i>	67
Table 4.5 Leaf constant number of <i>Erythroxylum novogranatense</i> , <i>Erythroxylum cambodianum</i> and <i>Erythroxylum cuneatum</i>	68
Table 4.6 Leaf constant number of <i>Tinospora crispa</i> and <i>Tinospora baenzigeri</i> .	69
Table 4.7 Primer combination, number of AFLP bands, size range and percentage of polymorphic band of two <i>Eurycoma</i> species	75
Table 4.8 Jaccard's coefficient similarity index between <i>E. longifolia</i> and <i>E. harmandiana</i> based on AFLP markers	75
Table 4.9 Primer combination, number of AFLP bands, size range and percentage of polymorphic band in three <i>Erythroxylum</i> species	78
Table 4.10 Jaccard's coefficient similarity index between <i>E. cambodianum</i> , <i>E. cuneatum</i> and <i>E. novogranatense</i> based on AFLP markers	78

Table 4.11 Primer combination, number of AFLP bands, size range and percentage of polymorphic band in two <i>Tinospora</i> species	81
Table 4.12 Jaccard's coefficient similarity index between <i>T. crispa</i> and <i>T. baenzigeri</i> based on AFLP markers.....	81
Table 4.13 Physicochemical parameters analysis of <i>E. longifolia</i> root.....	88
Table A1 Determination of stomatal number and stomatal index of <i>Erythroxylum novogranatense</i>	103
Table A2 Determination of stomatal number and stomatal index of <i>Erythroxylum cambodianum</i>	104
Table A3 Determination of stomatal number and stomatal index of <i>Erythroxylum cuneatum</i>	105
Table A4 Determination of stomatal number and stomatal index of <i>Tinospora crispa</i>	106
Table A5 Determination of stomatal number and stomatal index of <i>Tinospora baenzigeri</i>	107
Table B1 Determination of Loss on drying / Total ash / Acid-insoluble ash of <i>Eurycoma longifolia</i> Jack.....	108
Table B2 Determination of water-soluble extractive of <i>Eurycoma longifolia</i> Jack.....	109
Table B3 Determination of ethonol-oluble extractive of <i>Eurycoma longifolia</i> Jack.....	110

LIST OF FIGURES

- Figure 2.1** Botanical characteristics of *E. longifolia* Jack; (A) whole plant and habitat, (B) leaves, (C) inflorescences, (D) young fruits, (E, F) ripe fruits and (G) root.3
- Figure 2.2** Chemical structures of various biological active constituents from *E. longifolia*; (A) 7-Methoxybeta-carboline-1-propionic acid; (B) 9-methoxycanthin-6-one; (C) Laurycolactone; (D) Eurycolactone B; (E) Eurycomalide A; (F) Eurylactone; (G) Longilactone; (H) Eurycomalactone; (I) Eurycomanone; (J) Eurycomanol; (K) Pasakbumin B; (L) Hydroxyklaineanone; (M) Biphenyl-neolignan; (N) Quassin; (O) Niloticin; and (P) Eurylene.....4
- Figure 2.3** Botanical characteristics of *E. harmandiana* Pierre; (A) stem and root, (B) habitat, (C) leaves, (D) flowers, (E) inflorescences, (F) fruits, and (G) whole plant7
- Figure 2.4** Botanical characteristics of *E. novogranatense*; (A) whole plant and habitat, (B) leaves and fruiting branch, (C) flowers and fruits, (D) ripe fruits, (E) flowers, (F) young fruits and (G) ventral leaf showed parallel lines either side of the central vein.10
- Figure 2.5** Botanical characteristics of *E. cambodianum*; (A) branching of leaves, (B) leaves and fruiting branch, (C, D) young and ripe fruits, (E) dorsal leaves, (F) ventral leaf and (G) flower.....12
- Figure 2.6** Botanical characteristics of *E. cuneatum*; (A) branching of leaves, (B, C) flowers and young fruit, (D) leaves and fruit, (E) young and ripe fruits, (F) whole plant and habitat and (G, H) ventral leaf showed parallel lines either side of the central vein.14
- Figure 2.7** Botanical characteristics of *T. crispa*; (A) whole plant and habitat, (B) leaves, (C) stems and branching of leaves, (D) flower, (E) young fruits and (F) ripe fruits.....16

Figure 2.8 Botanical characteristics of <i>T. baenzigeri</i> ; (A) leaves, (B) stem and inflorescences, (C) whole plant and habitat, (D) leaf base showed two nodes appearing, (E) flowers, (F) young fruits and (G) ripe fruits.	18
Figure 2.9 The authentication methods for herbal medicines.....	19
Figure 2.10 The stomatal types; anomocytic or ranunculaceous (A), anisocytic or cruciferous (B), diacytic or caryophyllaceous (C) and paracytic or rubiaceus (D) .	22
Figure 2.11 Generating amplified fragment length polymorphism (AFLP) markers	29
Figure 4.1 Whole plant of <i>E. longifolia</i> Jack with inflorescences and fruiting branch (A), fruiting branch (B), flowers (C), and root (D).....	49
Figure 4.2 Whole plant of <i>E. harmandiana</i> Pierre with inflorescences (A), flowers and fruiting branch (B), and root (C)	50
Figure 4.3 Whole plant of <i>E. novogranatense</i> with flowers and fruits (A), and flower (B).....	52
Figure 4.4 Whole plant of <i>E. cambodianum</i> with flowers and fruits	53
Figure 4.5 Whole plant drawing of <i>E. cuneatum</i> with flowers and fruits (A), and flowers (B)	54
Figure 4.6 Whole plant drawing of <i>T. crispa</i> with fruits (A), and flowers (B).....	56
Figure 4.7 Whole plant of <i>T. baenzigeri</i> with inflorescences (A), and fruiting branch (B).....	57
Figure 4.8 Transverse section of leaf midrib of <i>Eurycoma longifolia</i> :	60
Figure 4.9 Transverse section of leaf midrib of <i>Eurycoma harmandiana</i> :	61
Figure 4.10 Transverse section of leaf midrib of <i>Erythroxylum novogranatense</i> : .	62
Figure 4.11 Transverse section of leaf midrib of <i>Erythroxylum cambodianum</i> :....	63
Figure 4.12 Transverse section of leaf midrib of <i>Erythroxylum cuneatum</i> :.....	64
Figure 4.13 Transverse section of leaf midrib of <i>Tinospora crispa</i> :	65

- Figure 4.14** Transverse section of leaf midrib of *Tinospora baenzigeri*:66
- Figure 4.15** Photographs of stomatal cells of two *Eurycoma* species: Lower surface of *Eurycoma longifolia* (a) and lower surface of *Eurycoma harmandiana* (b).70
- Figure 4.16** Photographs of stomata cells of three *Erythroxylum* species: lower surface of *Erythroxylum novogranatense* (a), lower surface of *Erythroxylum cambodianum* (b) lower surface stomata of *Erythroxylum cuneatum* (c).71
- Figure 4.17** Photographs of stomatal cells of two *Tinospora* species: lower surface of *Tinospora crispa* (a), upper and lower surface of *Tinospora baenzigeri* (b,c). ...72
- Figure 4.18** AFLP profile of 2 *Eurycoma* species in various locations and *Strychnos nux-vomica* (outgroup plant) obtained from E+ACG/M+CTT primer combinations 74
- Figure 4.19** UPGMA dendrogram based on Jaccard's similarity coefficient of *Eurycoma* species and outgroup plant. The scale bar indicated the genetic distance of 0.1 76
- Figure 4.20** AFLP profile of 3 *Erythroxylum* species in various locations and *Strychnos nux-vomica* (outgroup plant) obtained from E+ACG/M+CTT primer combinations. 77
- Figure 4.21** UPGMA dendrogram based on Jaccard's similarity coefficient of *Erythroxylum* species and outgroup plant. The scale bar indicated the genetic distance of 0.1 79
- Figure 4.22** AFLP profile of 2 *Tinospora* species in various locations *Strychnos nux-vomica* (outgroup plant) obtained from E+ACG/M+CTT primer combinations.....80
- Figure 4.23** UPGMA dendrogram based on Jaccard's similarity coefficient of.....82
- Figure 4.24** Photography of *Eurycoma longifolia* Jack; (A) habitat, (B) leaves, (C) ripe fruits, (D) young fruits, (E) inflorescences, (F) ripe flowers, and (G) young flowers .84
- Figure 4.25** Photograph of crude drug of *E. longifolia* root.....85

Figure 4.26 Transverse section of *E. longifolia* root: epidermis (1), epiderm (2), cortex (3), phloem (4), xylem (5), xylem vessel (6), xylem ray with starch granules (7), xylem fiber (8) and pith (9).....86

Figure 4.27 Powdered of *E. longifolia* root: cork in surface view (1); sclereid (2); fragment of bordered pitted vessel (3); fragment of fiber (4); cork in sectional view (5); parenchyma containing crystal of calcium oxalate (6); parenchyma containing starch grain (7); brownish mass (8); starch grain (9); fragment of parenchyma (10); fragment of medullary ray (11).....87

Figure 4.28 TLC fingerprint of *E. longifolia* root: under UV light 366 nm (I); under UV light 254 nm (II); under daylight after spray with p-anisaldehyde reagent (III) ...89



CHAPTER I INTRODUCTION

1. Background and rationale

Herbal medicine had been used for medicinal purposes and important role in health management system. A large number of medicinal plants are in use for their medicinal properties and becoming popular throughout the world including Thailand which have long been used in medical setting and maintain health system [1, 2]. The increase demand for botanical products is met by an expanding primary source of health care for most of world's population living in developing countries but also enjoys growing popularity in developed countries.

Medicinal plants were recognized by World Health Organization (WHO) as an essential for primary healthcare and used mostly as a complementary treatment [3]. Like any medicine, herbal plants can have side-effects in using as pharmaceutical properties. Some herbal plants and some remedies have also been shown to cause serious health problems from contamination and adulterant resulted from most of them have not been scientifically investigated. Due to the limitation of scientific evidence for the evaluation of herbal remedies, the accurate identification and quality control are essential for assurance of quality, safety and efficacy of herbal medicines [4].

According to the increasing demand in herbal medicine, the improvement in analysis and quality control for quality maintenance of herbal materials and their products has been stimulated. To ensure reproducible quality of any herbal plants, requirements and methods for research and evaluation are essential. There are many methods used for investigation or examination such as morphological observation and microscopic examinations. They are simple, rapid and inexpensive technique which were useful for quality assessment for many herbal materials [5-10]. However, herbal medicines are often sold as tablets, capsules, powders and crude drug. Combination of another characteristics such as pharmacognostic specification, biological, chemical and physical properties can also be used in medicinal plant identification [11].

Medicinal plants in genera *Eurycoma*, *Erythroxylum* and *Tinospora* have long been used in traditional medicine for antipyretic and antimalarial activities [12-15]. However, scientific standards or pharmacognostical parameters have not reported to ascertain the identification and determination of these herbs. According to the similarity in their morphological characteristics, it is difficult to identify each species by morphological observation. In addition, inadequately tested for their purity and safety of these plants materials prior to introduction into marketing products may lead to toxicological and pharmacological perspective. Therefore, correct identification and quality control of these Thai herbal plants may provide valuable information and are certain necessary for herbal medicinal used [3].

The authentication and sustainable use of plant genetic resources require accurate identification of their accession. Recently, DNA-based analysis have been developed and introduced for identification of herbal medicine [16-18]. Individual plant DNA carries the same genetic information which is not affected by environmental factors [19]. The properties of DNA markers include highly polymorphic nature, fast assay, high reproducibility and easy exchange of data between laboratories. The lack of adequate quality control leads to variability in the quantity and quality of the herbal products' content. The molecular authentication based on AFLP markers have been extensively used for phylogenetic analysis and determining the genetic diversity and may be provide useful information for its correct identification and will be used to maintain its quality control of the medicinal plants.

This study aims to investigate the necessary macroscopic, microscopic and DNA fingerprint of selected genera *Eurycoma*, *Erythroxylum* and *Tinospora* for medicinal authentication. The investigation obtained from this study is undertaken establish pharmacognostic profiles of the leaves which may be useful to supplement information with regard to its identification and will be helpful in establishing the standardization criteria of the quality control.

2. Research questions

2.1 Can macroscopic, microscopic evaluation and molecular evaluation using AFLP technique be distinguished two *Eurycoma* species (*Eurycoma longifolia* Jack and *Eurycoma harmandiana* Pierre) , three *Erythroxylum* species (*Erythroxylum novogranatense* (Morris) Hieron, *Erythroxylum cambodianum* Pierre and *Erythroxylum cuneatum* (Miq.)Kurz and two *Tinospora* species (*Tinospora crispa* (L.) Miers ex Hook.f.& Thomson and *Tinospora baenzigeri* Forman)?

2.2 Can the standardization parameter be established for the quantity of *Eurycoma longifolia* Jack?

3. Objectives

3.1 To examine the distinguishable characteristics of two *Eurycoma* species (*Eurycoma longifolia* Jack and *Eurycoma harmandiana* Pierre), three *Erythroxylum* species (*Erythroxylum novogranatense* (Morris) Hieron, *Erythroxylum cambodianum* Pierre and *Erythroxylum cuneatum* (Miq.)Kurz and two *Tinospora* species (*Tinospora crispa* (L.) Miers ex Hook.f.& Thomson and *Tinospora baenzigeri* Forman) by the microscopic examination and molecular authentication.

3.2 To establish the standardization parameter for establishment the quantity of *Eurycoma longifolia* Jack.

4. Benefits and applications

4.1 The macro/microscopic examination and molecular authentication can apply for the identification of other medicinal plants and can use for discrimination of the other medicinal plants for the further study.

4.2 The standardization parameters can provide the correct identity, purity and quality of medicinal used.

4.3 For molecular authentication, unique band can be provide the SCAR technique and develop for specific marker to identify the selected genera *Eurycoma*, *Erythroxylum* and *Tinospora*.

4.4 This study provides an important scientific information of microscopic and molecular characteristics of selected genera *Eurycoma*, *Erythroxylum* and *Tinospora* in Thailand.

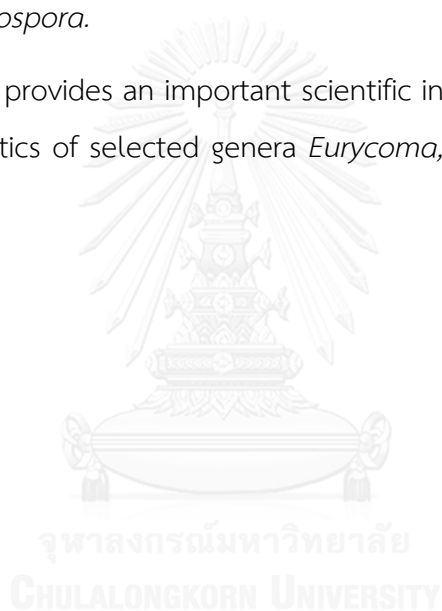

5. Conceptual framework

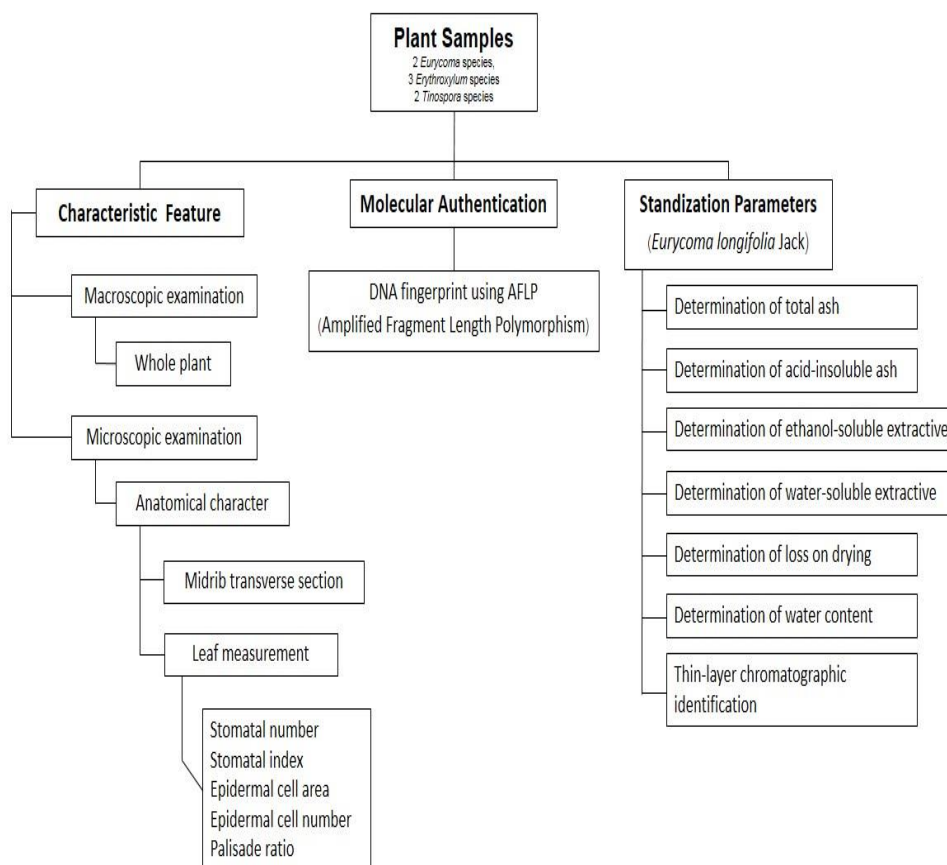

CHAPTER II

LITERATURE REVIEW

Plant samples of this study were composed of two *Eurycoma* species (*Eurycoma longifolia* Jack and *Eurycoma harmandiana* Pierre) in family Simaroubaceae, three *Erythroxylum* species (*Erythroxylum novogranatense* (Morris) Hieron, *Erythroxylum cambodianum* Pierre and *Erythroxylum cuneatum* (Miq.) Kurz in family Erythroxylaceae and two *Tinospora* species (*Tinospora crispa* (L.) Miers ex Hook.f.& Thomson and *Tinospora baenzigeri* Forman in family Menispermaceae.

2.1 Plant samples in genus *Eurycoma*

Eurycoma is a small genus of three or four species of flowering plants in the family Simaroubaceae, native to tropical Southeast Asia. They are small evergreen trees with spirally arranged pinnate leaves. The flowers are small, produced in large panicles.

2.1.1 *Eurycoma longifolia* Jack

Eurycoma longifolia Jack is one of the most well-known herbal folk medicines in Southeast Asia. Its roots are traditionally used for many disorders and diseases in many countries in Asia. Recently *E. longifolia* has contributed good role as a complementary and alternative medicine in herbal therapies in the West.

Eurycoma longifolia Jack is a tall and slender shrub-tree that native to Southeast Asia such as Burma, Indochina, Laos and Thailand. It belongs to the Simaroubaceae family. *E. longifolia* known locally as “Tongkat Ali” in Malaysia, “Pasakbumi” in Indonesia, “Cay ba benh” in Vietnam and “Lan-Don” or “Pla lai phueak” in Thailand and it is used more routinely for traditional medicine purposes [20].

The pharmacological effects was closely associated with various biologically active compounds of *E. longifolia* roots, stem, leaves and even bark, which includes quassinoids, β -carboline alkaloids, canthin-6-one alkaloids, triterpene-type tirucallane,

squalene derivatives, and eurycolactone, eurycomalactone, laurycolactone, biphenyl neolignan, bioactive steroids, longifolione D and longifolione E [12, 21-24].

Eurycoma longifolia is a small, everred treelet growing to 15 m tall with spirally arranged, pinnate leaves, The numerous leaflets are opposite or subopposite, lanceolate to ovate-lanceolate, 20-40 cm long with 13-41 leaflets, 1.5-6 cm wide and green colour with smooth margins. The flowers are dioecious, tiny, reddish with male and female flowers on different trees; they are produced in large panicles, each flower with 5-6 very small petals. The flower are densely arranged and they turn dark reddish brown when ripe. The fruit is green ripening dark red, 1-2 cm long and 0.5-1 cm broad [21]. The botanical characteristics of *E. longifolia* were showed in **Figure 2.1**.

The quassinoids are the main chemical constituents including various types of eurycomanone, eurycomanols, pasakbumin-B, hydroxyklaineanones, eurycomalactones, eurycomadilactones, eurylactones and longilactonesand. These quassinoids have been isolated from the roots of *E. longifolia* which a group of nortriterpenoids with dynamic pharmacological properties (**Figure 2.2**) [13, 25].



Figure 2.1 Botanical characteristics of *E. longifolia* Jack; (A) whole plant and habitat, (B) leaves, (C) inflorescences, (D) young fruits, (E, F) ripe fruits and (G) root.

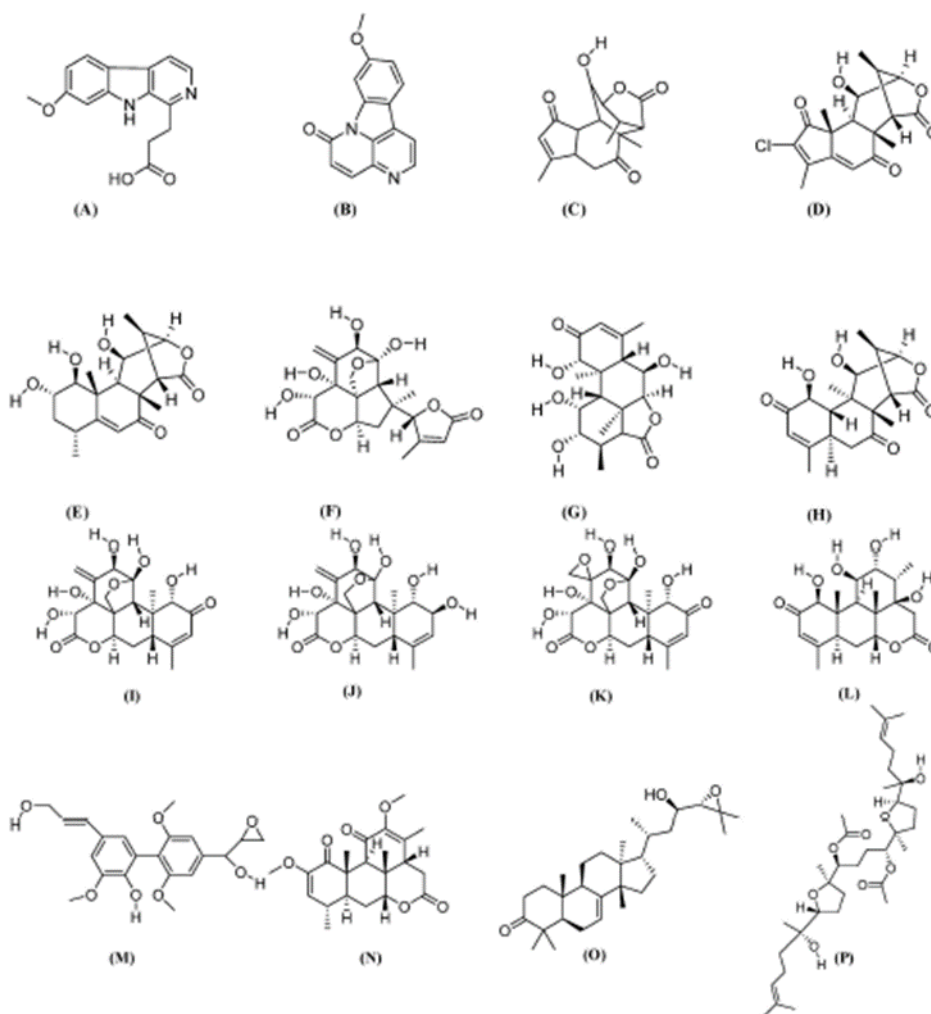

Figure 2.2 Chemical structures of various biological active constituents from *E. longifolia*; (A) 7-Methoxy-beta-carboline-1-propionic acid; (B) 9-methoxycanthin-6-one; (C) Laurycolactone; (D) Eurycolactone B; (E) Eurycomalide A; (F) Eurylactone; (G) Longilactone; (H) Eurycomalactone; (I) Eurycomanone; (J) Eurycomanol; (K) Pasakbumin B; (L) Hydroxyklaineanone; (M) Biphenyl-neolignan; (N) Quassin; (O) Niloticin; and (P) Eurylene.

For the evidenced-based pharmacology, this plant is popularly sought after in herbal remedies and has been frequently prescribed either as a single ingredient or as a mixture with other herbs. The roots of this plant have active ingredients which are eurycolactone and others. Research in animals and humans suggests it might increase testosterone in the body as male fertility enhancement used as a folk medicine for sexual dysfunction [26], used as antimalarial [27], increased strength, cytotoxic and anti-proliferative [12, 23], antimicrobial [28], anti-inflammatory [29], antidiabetic [30] and it is also used as appetite stimulant and health supplement [21].

In Thai traditional medicine, root of *E. longifolia* is one of herbal plant in Chanta-lee-la herbal household remedy that used since ancient times for antipyretic [31]. Interestingly, several studies have been reported to provide scientific base for the traditionally popular *E. longifolia* extracts against malaria or the intermittent fever, especially the results showed significant antimalarial activity against *Plasmodium falciparum* [32, 33].

Eurycoma longifolia is one of the most useful and safe traditional herbal medicines. Based on established literature on the health benefits of *E. longifolia*, it is important to focus more attention on its more active constituents and these constituents' identification, determination, further development and most importantly, standardization. Besides the available data, more evidence regarding its therapeutic efficacy and safety is required, to establish proper clinical recommendations for *E. longifolia*'s safe use and very important to conserve this valuable medicinal plant for the health benefit for the future.

2.1.2 *Eurycoma harmandiana* Pierre

Eurycoma harmandiana Pierre is a small shrub in simaroubaceous plant that distributed on the border regions between Thailand and Laos. This species in Thai called Pla Lai Pheuak Lek, Lane Don and Ya Hak Diaw. In North-eastern Thai traditional medicine, the root is used as a bitter tonic, as well as an aphrodisiac, anticancer and antimalarial agent.

For distribution, this plant is occurring in the south of Laos, Cambodia and Northeast Thailand (usually distributed on the border regions between Thailand and Laos). It was found mainly in dry dipterocarp or mixed forest, also in grass field, along streams and rocky outcrops or sandy soils.

Eurycoma. harmandiana is a small shrub to 30 cm, rarely up to 50 cm tall, with large 20-70 cm long single yellow-white tap root. Stem is brownish-black or dark red. Leaf is rigid and thin, pinnately compound (imparipinnate; with an odd number of leaflets, pinnate with terminal leaflet), each compound leaf consists of 5-11 leaflets with a linear shape (thin and elongated leaf with parallel side), no petiole, entire margin (smooth margin without tooth), 0.3-0.5 cm wide and 3-7 cm long. Inflorescences are arranged in a pinnacle of 10-20 long, which are reddish-brown, with a small pink to red flowers. Red fruit, round to 5-8 mm. The botanical characteristics of *E. harmandiana* were showed in **Figure 2.3**.

In the previous research, researcher were studied about isolation and founded the structural elucidation of nine alkaloids, consisting of the two new alkaloids together with the known canthin-6-one alkaloids and the known β -carboline alkaloid; canthin-6-one 9-O- β -glucopyranoside and 7-hydroxy- β -carboline 1-propionic acid, were isolated from the roots of *Eurycoma harmandiana*, together with the five known canthin-6-one alkaloids, 9-hydroxycanthin-6-one, 9-methoxycanthin-6-one, 9,10-dimethoxycanthin-6-one, canthin-6-one and canthin-6-one N-oxide, and the two known β -carboline alkaloids, β -carboline 1-propionic acid and 7-methoxy- β -carboline 1-propionic acid [14, 34].



Figure 2.3 Botanical characteristics of *E. harmandiana* Pierre; (A) stem and root, (B) habitat, (C) leaves, (D) flowers, (E) inflorescences, (F) fruits, and (G) whole plant

2.2 Plant samples in genus *Erythroxylum*

Erythroxylum is a genus of tropical flowering plants in the family Erythroxylaceae. Many of the approximately 200 species contain the drug cocaine; *Erythroxylum coca*, a native of South America, is the main commercial source of cocaine and of the mild stimulant coca tea. Another species, *Erythroxylum vacciniifolium* (also known as Catuaba) is used as an aphrodisiac in Brazilian drinks and herbal medicine. In Thailand, three *Erythroxylum* species in this study were used in traditional medicine of antipyretic and another. A distinguishing characteristic of several species in this genus is the ability to produce cocaine from the leaves and the leaves have parallel lines on either side of the central vein [35, 36]. Little is known of the function of cocaine and the associated alkaloids in the plant [37].

2.2.1 *Erythroxylum novogranatense* (Morris) Hieron

Erythroxylum novogranatense (Morris) Hieron belong to family Erythroxylaceae which is a trees and shrubs distributed across tropical regions of South America, Africa and Madagascar. Some study indicates this species cultivated for cocaine production [38, 39]. The biological activity of the following alkaloids has been reported in previous study: cocaine, cinnamoylcocaine, benzoylecgonine, methylecgonine, pseudotropine, benzoyltropine, tropacocaine, α - and β -truxilline, hygrine, cuscohygrine and nicotine [40].

Erythroxylum novogranatense was originally identified as *E. coca*, subsequently described as a variety, and finally came to be recognized as its own species. This plant is a highland variety that is utilized in lowland areas. It is cultivated in drier regions in South America, where it requires irrigation. However, *E. novogranatense* is very adaptable to varying ecological conditions, and grows well in both humid and dry areas, and at low and higher altitudes. In Java (Indonesia), this species has been cultivated from sea-level to 1,000 m altitude, with best results at 400–600 m. In controlled environment studies, the optimum average daily temperature for leaf growth was found to be around 27 °C. Environmental effects on the cocaine concentration in the leaves were smaller, so that total cocaine production per plant was largely a function of leaf mass, with environmental conditions that stimulated leaf growth giving higher cocaine yields.

The basic physical difference between *E. coca* and *E. novogranatense* is that the *E. coca* (sometimes called *E. bolivianum*) has larger leaves that are elliptical, oval and broader near the middle (broad-elliptic) and darker green color above. The *E. novogranatense* has smaller, narrower leaves, broadest near the apex (oblong-obovate), and bright green color above. The characteristics of *E. novogranatense* has narrower leaves, broadest near the apex (oblong-obovate), and bright green color above. The leaves has possess parallel lines either side of the central vein.

For description of this plant, *E. novogranatense* is a shrub tree that can grow up to 1-3 m tall, with leaves that are bright green, alternate, obovate or oblong-elliptic and on about a 0.5 cm long petiole. The leaves are about 2 to 6 cm long and 1 to 3 cm broad. The flowers are hermaphrodite, solitary or grouped, axillary, and with five yellowish, white petals, about 0.4 cm long and 0.2 cm wide. The fruits are drupes, of oblong shape and red color, with only one oblong seed. They get to be about 0.8 cm long and 0.3 cm in diameter. The leaf of *E. novogranatense* tends to have a paler green color, more rounded apex, and be somewhat thinner and narrower than the leaf of *E. coca*. The botanical characteristics of *E. novogranatense* were shown in **Figure 2.4**.





Figure 2.4 Botanical characteristics of *E. novogranatense*; (A) whole plant and habitat,(B) leaves and fruiting branch, (C) flowers and fruits, (D) ripe fruits, (E) flowers, (F) young fruits and (G) ventral leaf showed parallel lines either side of the central vein.

2.2.2 *Erythroxylum cambodianum* Pierre

Erythroxylum cambodianum Piere belongs to family Erythroxylaceae. It is a shrub and distributed in Northeastern Thailand. This plant species used in Thai traditional medicine for anti-fever purposes, as well as an anti-inflammatory agent. The phytochemical study carried out on this species is limited.

In Thailand, it is called in various names as Ya Hun Hai (Northern), Kaen Daeng (Prachin Buri), Khet Mun (Prachin Buri), Cham-Eng-Sek (Khmer-Surin), Chetta Mun (Prachin Buri), Don Thung (Eastern), Tan Khrop (Northern), Tan Huan Hot (Northern), Phak Khom Khok (Nakhon Ratchasima), Ma Hok Ton (Northern) and Run Rai (Central, Si Sa Ket).

For plant descriptions, *E. cambodianum* is a shrub to 50-90 cm tall, gray to brown colour of stem. Leaves are elliptic or obovate shape, alternate, 2.5-3 cm wide and 10-15 cm long, entire margin, dark green colour. False midrib is even more visible on the under face of the leaf. Flower is in clusters on short stalks, white or greenish white to light green petals, 1.5-2 mm wide and 3-5 mm long, flowers on leafy branches. Fruits are ripening shiny bright red, ellipsoid, curved, triangular, 3-5 mm wide and 8-12 mm long. Seed is fertile locule, flattened, 1.5-3 mm wide and 6-10 mm long. The botanical characteristics of *E. cambodianum* were showed in **Figure 2.5**.

However, previous study in phytochemical investigation of plants in this genus showed the presence of alkaloids, flavonoids, tannins, triterpenoids and phenolic compounds [41]. Two new acetophenone diglycosides, erythroxylosides A and B, were isolated from the aerial portion of *Erythroxylum cambodianum* together with (+)-catechin, (+)-epicatechin, quercetin 3-O-rutinoside, (3S,5R,6R,7E,9S) megastigman-7-ene-3,5,6,9-tetrol 3-O-β-D-glucopyranoside and citroside A. The structural elucidations were based on analyses of chemical and spectroscopic data [42].



Figure 2.5 Botanical characteristics of *E. cambodianum*; (A) branching of leaves, (B) leaves and fruiting branch, (C, D) young and ripe fruits, (E) dorsal leaves, (F) ventral leaf and (G) flower.

2.2.3 *Erythroxylum cuneatum* (Miq.) Kurz

Erythroxylum cuneatum (Miq.) Kurz in Thai name called Krai-Tong or Ket-Mool, it belongs to family Erythroxylaceae that is a tree, widely distributed in South-East Asia. It is used in Thai traditional medicine for anti-fever purposes, as well as an anti-inflammatory agent. This plant has remained elusive in traditional medicine except for few reports saying that the leaves of this tree have been used as a fish poison in the Philippines. For last testing, this species had shown the ability to attenuate withdrawal symptoms in morphine dependent rats and could be investigated further as a source of alternative remedy for opium addiction. In a previous study, the constituents of this plant were investigated and tropane alkaloids were reported [43].

For plant descriptions, this species is a small to large tree or a shrub, 1-40 m, up to 35-55 cm diameter. Bark noted to be grey to brown often with vertical grooves, inner bark yellow to reddish brown. Branches 1.5-4 mm diameter, brown to black when dried, the tips 1-3 mm diameter. Leaves are very variable in size and shape, even on the same twig, mostly obovate, elliptic or oblong, 3-18 cm long and 2-7 cm wide; dark green to greenish brown often shining above, dull light green beneath, shortly acuminate or rounded with a more or less emarginate, mostly mucronate tip, base attenuate or cuneate; midrib nearly always sunken above, very prominent beneath; nerves on both sides equally distinct, often almost horizontal and close together giving a dense nervation, venation delicate; areolation often distinct; petiole 2-9 mm. Stipules are triangular to lanceolate, mostly as long as the petiole, not divided, entire, distinctly bicarinate 2-9) mm, top mostly curved. Flowers in clusters of 1-8, mostly in pairs, faintly scented. Calyx tube 2-1.5 mm high; lobes triangular 0.5-1.5 mm, acuminate with a bluntish tip. Petals are white, whitish green to light green and yellow (also pink recorded from Central Celebes), oblong or oblong-elliptic, convex 3-4 by 1.5-2 mm; ligule 3-lobed, half as long as the blade; claw often distinctly narrowing towards the base 1/3 as long as the petal. Flowers are dimorphous, both types either with equal or unequal stamens. Drupe is oblong-ovoid, often somewhat curved, red, when dry obtusely trigonous, distinctly furrowed, top pointed 7-12 by 3-6 mm; bilaterally compressed, sterile cells distinct and large, on both sides of the fertile cell. Seed is flattened often somewhat curved, with distinct furrows 5-10 by 1-2.5 mm, little

endosperm; flattened embryo, slightly curved or straight, green colour, 4-8 mm wide and 0.5-1.5 mm long; cotyledons linear, very thin 2.5-6 by 0.5-1.5 mm; radicle distinct 1.5-3.5 mm. The botanical characteristics of *E. cuneatum* were showed in **Figure 2.6**.



Figure 2.6 Botanical characteristics of *E. cuneatum*; (A) branching of leaves,(B, C) flowers and young fruit, (D) leaves and fruit, (E) young and ripe fruits, (F) whole plant and habitat and (G,H) ventral leaf showed parallel lines either side of the central vein.

2.3 Plant samples in genus *Tinospora*

The genus *Tinospora* is in the family Menispermaceae in the major group Angiosperms (Flowering plants) in the family Menispermaceae. This genus includes 34 species which several herbs were used as traditional medicines by indigenous groups throughout the tropical and subtropical parts of Asia, Africa, and Australia. *Tinospora* species are a group of important medicinal plants which commonly used as domestic folk medicine for the ethnomedical treatment of colds, headaches, pharyngitis, fever, diarrhea, oral ulcer, diabetes, digestive disorder, and rheumatoid arthritis.

2.3.1 *Tinospora crispa* (L.) Miers ex Hook.f.& Thomson

Tinospora crispa (L.) Miers ex Hook.f.& Thomson belongs to family Menispermaceae, in Thai called Borapet. It is found in primary rainforests or mixed deciduous forests throughout a large part of Asia and Africa, including all parts of Thailand, Malaysia and Indonesia.

The characteristics of this plant is a woody climber up to 15 m long, older stems very prominently tuberculate and producing very long filiform aerial roots; lwaves broadly ovate to orbicular, 7-14 cm long and 6-12 cm wide, without domatia; inflorescences appearing when plant is leafless; flowers usually with 3 petals; fruit ellipsoidal, about 2 cm long, orange colour. The stem contains an exceedingly bitter milky sap. The botanical characteristics of *T. crispa* were showed in **Figure 2.7**.

For ethnomedical use, this plant species used for treatment of fever, jaundice, cholera, malaria, and against worms in children. In Thai traditional medicine, a decoction from the stems of *Tinospora crispa* has been used as an antipyretic, treating internal inflammations, reducing thirst, increasing appetite, cooling down the body temperature and maintaining good health. In previous research, this species was used to studies for decrease blood pressure [44], hypoglycemic or antihyperglycaemic action [45, 46], immunomodulatory effects [47], cardiovascular system which decreasing blood pressure and heart rate [48], enhancement of insulin sensitivity which may contribute to the hypoglycemic action [49] and hepatoprotective activity in rats [50].



Figure 2.7 Botanical characteristics of *T. crista*; (A) whole plant and habitat, (B) leaves, (C) stems and branching of leaves, (D) flower, (E) young fruits and (F) ripe fruits.

2.3.2 *Tinospora baenzigeri* Forman

Tinospora baenzigeri, in Thai called Ching chae cha lee, is a medicinal plant of the family Menispermaceae. It is a deciduous climbing shrub indigenous to tropical Indian subcontinent and commonly found in hedges. This plant is widely used in the Ayurvedic system of medicine for its general tonic, anti-inflammatory, anti-arthritic, antiallergic, anti-malarial, anti-diabetic, aphrodisiac properties and immune system [47].

This plant species is a large, deciduous extensively spreading climbing shrub with several elongated twining branches. Leaves are simple, alternate, exstipulate, long petioles up to 15 cm long, roundish, pulvinate, both at the base and apex with the basal one longer and twisted partially and half way around. Lamina is broadly ovate or ovate cordate, 10–20 cm long or 8– 15 cm broad, 7 nerved and deeply cordate at base, membranous, pubescent above, whitish tomentose with a prominent reticulum beneath. Flowers are unisexual, small on separate plants and appearing when plant is leafless, greenish yellow on axillary and terminal racemes. Sepals are 6 and free in two series of three each, the outer ones are smaller than the inner. Petals 6 free smaller than sepals, obovate and membranous. Fruits aggregate of 1-3, ovoid smooth drupelets on thick stalk with sub terminal style scars, scarlet or orange colour. The botanical characteristics of *T. baenzigeri* were shown in **Figure 2.8**.

The active adaptogenic constituents in this plant are diterpene compounds including tinosporone, tinosporic acid, cordifolisides A to E, syringen, the yellow alkaloid, berberine, Giloin, crude Giloininand, a glucosidal bitter principle as well as polysaccharides, including arabinogalactan polysaccharide (TSP), Picrotene and bergenin.

In traditional Indian medicinal plant, this species was found to possess anticomplementary and immunomodulatory activities. The stem is commonly used for Ayurvedic preparations in general debility, dyspepsia, fever, and urinary diseases. *Tinospora baenzigeri* Forman and similar species like *Tinospora crispa* and *Tinospora rumphii* Boerl are used in Ayurvedic and Jamu herbal medicine as a hepatoprotectant, protecting the liver from damage that may occur following exposure to toxins. Recent

research has demonstrated that a combination of *T. cordifolia* extract and turmeric extract is effective in preventing the hepatotoxicity.



Figure 2.8 Botanical characteristics of *T. baenzigeri*; (A) leaves, (B) stem and inflorescences, (C) whole plant and habitat, (D) leaf base showed two nodes appearing, (E) flowers, (F) young fruits and (G) ripe fruits.

2.4 Medicinal plant identification

The first step to categorize the medicinal plant materials is the determination according to their macroscopic and microscopic characteristics for establishing the identity and the degree of purity of medicinal plant materials. Visual by eye based on the appearance of morphology, size, and color provides the simplest and quickest inspection. However, macroscopic identification is sometime inadequate. It is often necessary to combine with other methods such as microscopic, physicochemical, or molecular analysis (Figure 2.9) [51].

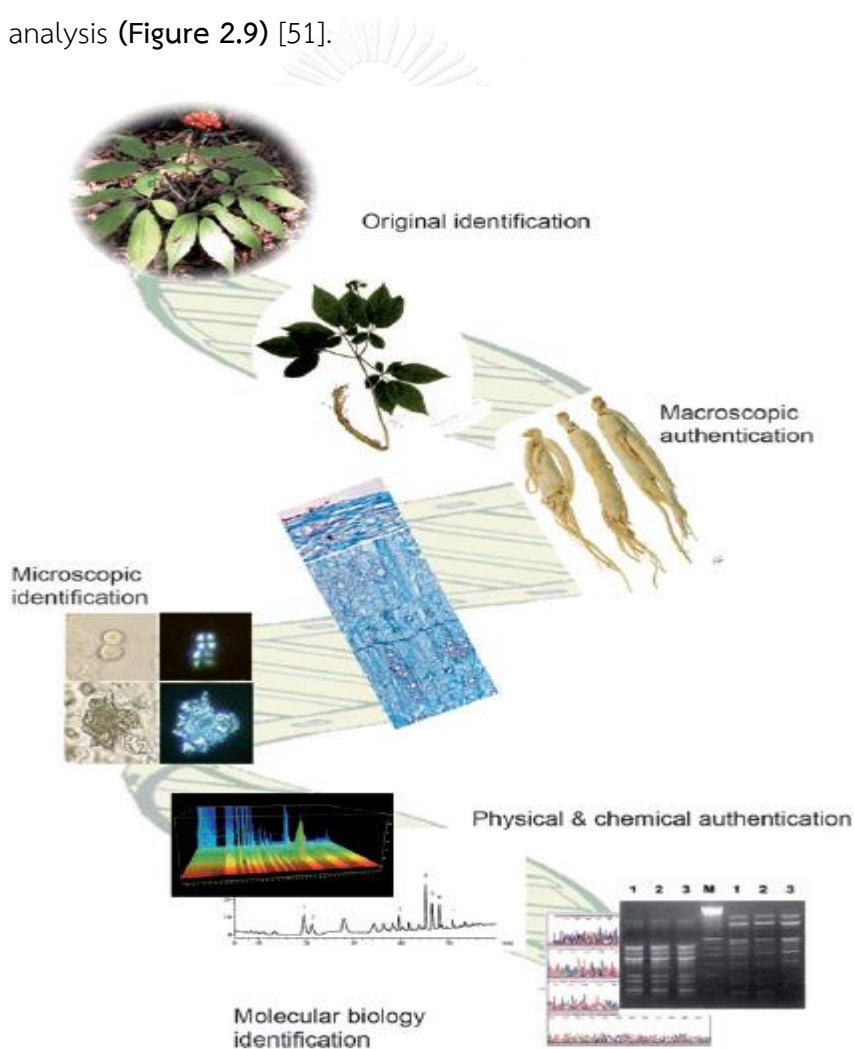

Figure 2.9 The authentication methods for herbal medicines

2.4.1. Pharmacognostic specification

Medicinal plant materials are categorized according to sensory, macroscopic and microscopic characteristics. An examination to determine these characteristics is the first step towards establishing the identity and the degree of purity of such materials, and should be carried out before any further tests are undertaken. The quality control methods should be available to serve as a reference, because these methods are plays an important role in traditional medicine which conserve as a tool for identification, authentication and quality control herbal drug [5].

World Health Organization (WHO) had published the “*Quality control methods for medicinal plant materials*” a recommended test procedure to evaluate the identity, purity and quality of the plant materials. The guidelines define that the quality and authenticity of the final botanical products is directly related to the proper identification and authenticity of the source materials. Macroscopic and microscopic methods are the effective tool to establish the correct identity of the plant materials.

2.4.1.1 Macroscopic examination

The macroscopic examination or the organoleptic characteristics of plant materials are based on their morphological features. This method is the description of shape, size, color, texture, other characteristics and appearance of the cut surface either with the naked eye or with simple magnification such as with a hand lens or under microscope [5]. This methods are always used to distinguish various species or evaluate their quality. There are conducted by the observing, touching, smelling, tasting and testing by some other ways. The evaluation of this parameter can provide a qualitative assessment of adulterating species such as organic or non-organic contaminants, and material degradation.

2.4.1.2 Microscopic anatomical examination

Anatomical characters of plant samples were investigated under photomicroscope observation under objective lens with a 10X, 20X and 40X magnifications and eyepiece lens of 10X magnification on the optical system by

microscope and refers to analysis of size, shape and other internal features characteristics.

2.4.1.3 Microscopic measurement

One of possible visual inspection usually used for determination is leaf measurement that is a constant number used to examine the identification of each plant [5]. Leaf constant numbers are used to identify between some closely related species. They have great value for a quality of the medicinal plants based on their specific characters. Leaf constant numbers can be measured by the stomatal number, stomatal index, epidermal cell number, epidermal cell area, cicatrix number, cicatrix index, trichome number, trichome index, vein-islet number, vein termination number and palisade ratio [6, 52].

2.4.1.3.1 Stomatal type

Stomata is a pore that found in the leaf and stem epidermis that is used for gas exchange. The pore is bordered by a pair of specialized parenchyma cells known as guard cells which are responsible for regulating the size of the opening. Stomata are frequently present in the lower epidermis of the leaf. The structure and shape of the epidermis and stomata are the first investigation in the microscopic examination of leaf. For this method, can be distinguished by their form and arrangements in the surrounding cells.

There are four types of stomata are often available for matured leaves. Anomocytic or ranunculus stomata is irregular cell type. Here the stomata is surrounded by varying number of cells, which are generally not different from those of the epidermis. Anisocytic or cruciferous stomata is an unequal cell type, where the stomata is usually surrounded by three or four subsidiary cells one of which markedly small than the other. Diacytic or caryophyllaceous is a cross-celled type. The stomata is accompanied by two subsidiary cells, the common wall of which is at right angle to the stomata. Paracytic or rubiaceous is a parallel cell type. Here the stomata has two subsidiary cells with the parallel long axis of the stomata [5, 6]. The stomatal types were showed in **Figure 2.10**.

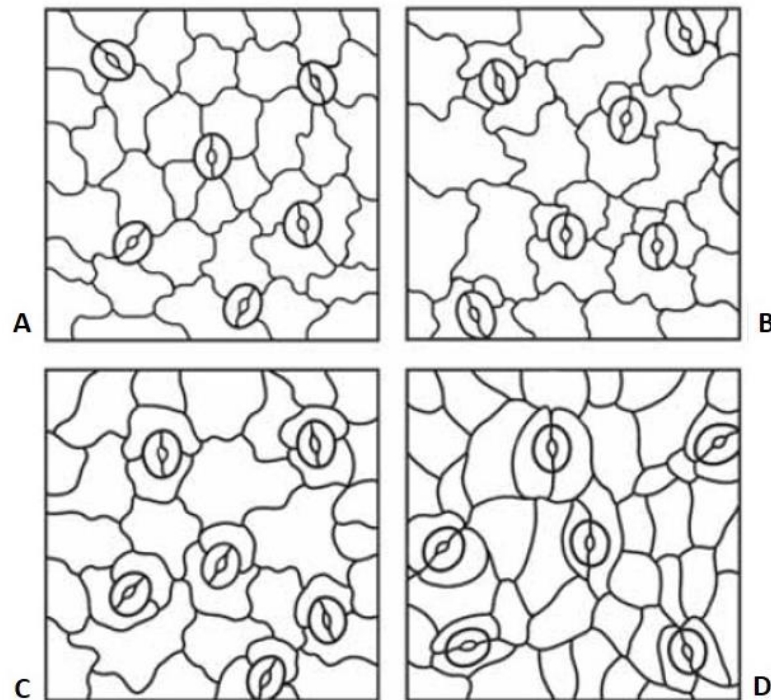

Figure 2.10 The stomatal types; anomocytic or ranunculaceous (A), anisocytic or cruciferous (B), diacytic or caryophyllaceous (C) and paracytic or rubiaceus (D)

2.4.1.3.2 Stomatal number

Stomatal number is the average number of stomata per square millimeter (mm^2) of epidermis and the number on each surface of the leaf. Each stomata consists of two guard cells and pore is counted as a single unit. This method is quantified the number of stomata per one square millimeter (mm^2) on the lower epidermis of leaf and determining by the average value (mean) in each area.

2.4.1.3.3 Stomatal index

Stomatal index is defined as the percentage of stomata from the total number of epidermal cells present in the area of square millimeter (mm^2), which can be explained as followed;

$$\text{Stomatal index} = [(S \times 100) / (S + E)]$$

Where S is the number of stomata in a given area of leaf and E is the

total number of epidermal cells of leaf and then calculate the stomatal index by using this formula for each of the thirty fields.

Stomata index is not affected by various factors such as size of the leaf, environmental conditions etc. It is relatively constant and consequent parameter [6].

2.4.1.3.4 Palisade ratio

Palisade cells found within the mesophyll in leaves and are positioned towards the upper surface of the leaf and contain the largest number of chloroplasts per cell in plants. Palisade ratio is another criteria for identification and evaluation of herbal drugs. It can be defined as the average number of palisade cells present beneath each upper epidermal cell. Palisade ratio is the average number of palisade cells beneath one epidermal cell of a leaf by counting the palisade cell beneath four contiguous epidermal cells. Then divided by four gives the palisade ratio of that group [6].

This value remains constant within a range for a given plant species and is of diagnostic value in differentiating the species. This value does not alter based on geographical variation and differs from species to species and that is why it is a very useful diagnostic feature for characterization and identification of different plant species.

These parameters are suitable as a primary means of identification of a sample and can provide very useful supportive evidence, which when taken together with other factors can make a positive evaluation and identification. To evaluate a number of different parameters and to choose the most effective parameters for identification is important. If there is standard data available for the identification and evaluation of some crude drugs based on these parameters, then by evaluating the same parameters of different other plants, it is possible to determine the characteristics of other crude drugs and thereby to establish their identity.

2.4.1.4 Standardization parameters

2.4.1.4.1 Determination of total ash

A high ash value is indicative of contamination, substitution, adulteration or carelessness in preparing the crude drug for marketing. Total ash is designed to

measure the total amount of material produced after complete incineration of the ground drug at as low (450 °C) and high (800 °C) temperature. The total ash usually consists of carbonates, phosphate, silicates and silica which include both physiological ash-which is derived from the plant tissue itself and non-physiological ash which is the residue of the adhering material to the plant surface e.g. sand and soil. This method is determined the total mineral content or amount of the residual substances [5].

2.4.1.4.2. Determination of acid-insoluble ash

Ash insoluble in hydrochloric acid is the residue obtained after extracting the total ash with dilute hydrochloric acid, and igniting the remaining insoluble matter. This measures the amount of silica, especially as sand and siliceous earth. This method is measured the amount of ash insoluble to diluted hydrochloric acid.

2.4.1.4.3. Determination of solvent extractive values

This method determines the amount of active constituents in a given amount of medicinal plant material when extracted with solvents. It is employed for materials for which as yet no suitable chemical or biological assay exists. The extraction of any crude drug with a particular solvent yields as solution containing different phyto-constituents. The composition of these phyto-constituents in that particular solvent depends upon the nature of the drug and solvent used. The use of a single solvent can be the means of providing preliminary information on the quality of a particular drug sample.

2.4.1.4.4. Determination of loss on drying

An excess of water in medicinal plant materials will encourage microbial growth, the presence of fungi or insects, and deterioration following hydrolysis. This is especially important for materials that absorb moisture easily or deteriorate quickly in the presence of water. Loss on drying is the loss of mass expressed as percent w /w. This method is measured the amount of water and volatile matters in a dried sample.

2.4.1.4.5. Determination of water content

Moisture is an inevitable component of crude drugs, which must be eliminated as far as practicable. The preparation of crude drug from the harvested drug plants involves cleaning or garbling to remove soil or other extraneous material followed by

drying which play a very important role in the quality as well as purity of the material. Insufficient drying favors spoilage by molds and bacteria and makes possible the enzymatic destruction of active principles. This method is determined the quantity of water contained in a plant samples. This method is determined amount of active constituents extracted with distilled water from a given amount of medicinal plant material.

2.4.1.4.6. Thin-layer chromatography (TLC) identification

Thin-layer chromatography is a particularly valuable for the qualitative determination of small amounts of impurities and quality control method for medicinal plant. The chromatography technique used for determine how many components are in a mixture and identity of a compound in a mixture separate mixtures [5]. As it is effective and easy to perform, and the equipment required is inexpensive, the technique is frequently used for evaluating medicinal plant materials and their preparations. Thin-layer chromatography is used for the rapid separation of compounds. The most common stationary phase is silica gel.

2.4.2. Molecular authentication

According to the forensic tool, the world of DNA fingerprinting has a long way in revealing the genetic identity of living beings. The conservation and sustainable use of plant genetic resources require accurate identification of their accession. The advance in molecular genetics over the last few years have provided workers involved in the conservation of plant genetic resources with a range of new techniques for easy and reliable identification of plant species. In plants it has not only helped in identifying species but also in defining a new real in plant genomics, plant authentication, plant breeding and in conserving the biodiversity. For the developments in biotechnology, DNA fingerprinting promises a very powerful tool in our future endeavors.

The properties of DNA markers include highly polymorphic nature, frequent occurrence in genome, easy access (availability) , easy and fast assay, high reproducibility, and easy exchange of data between laboratories. Molecular authentication has more advantage over typical phenotype markers and reliable for

informative polymorphisms [16]. Various types of DNA-based molecular techniques are utilized to evaluate DNA polymorphism. These are hybridization-based method, polymerase chain reaction (PCR)-based methods and sequencing-based methods.

2.4.2.1 DNA isolation

High molecular weight DNA from plant tissue can be isolated in a number of ways. All methods involves basic steps of removal of all cell wall and nuclear membrane around the DNA and the separation of DNA from other cell components such as cell debris, proteins, lipids or RNA without affecting the integrity of the DNA [18].

The most commonly preferred method is CTAB method. The DNA is isolated from tissues of plants, generally leaves are preferred. A unit mass of leaf (about 1 g) is taken and powdered in a mortar and piston using liquid nitrogen. The powdered sample is quickly transferred to the microcentrifuge tube (in order to avoid phenolic oxidation) containing extraction buffer containing, CTAB, NaCl, EDTA, TrisHCl, β -Mercaptoethanol. CTAB lyses the cell wall at the same time it forms a complex with DNA and precipitates it. EDTA is often included in the extraction buffer to chelate magnesium ions, a necessary cofactor for most nucleases. NaCl breaks the insoluble complex and then nucleic acid can be concentrated by ethanol precipitation. NaCl removes polysaccharides present in the cell free extract. TrisHCl maintains the pH and stabilize the chemicals released from cells. The mixture after centrifugation was treated with chloroform: isoamyl alcohol (24:1) was added to remove the cell free extract protein and phenolic contents. After centrifugation the supernatant is taken and treated with ice cold isopropanol to precipitate the DNA, the precipitate is further treated using 70% ethanol to further precipitate the DNA. RNase an enzyme was added to remove the RNA contamination. The sample was stored for further use at 4°C.

2.4.2.2 DNA quantification and quality assessment

DNA quantification and quality assessment is done by using UV-VIS spectrophotometry. Normally quality check is performed through the A260/A280 ratio that is 1.8 value shows the highest purity, if more than 1.8 shows the presence of RNA contamination and less than that shows the protein contamination. Gel

electrophoresis is conducted of isolated DNA samples for visualization of bands. For perfect extraction, there will be clear single bands otherwise smear like image will be seen. For PCR based methods, the DNA samples are diluted for PCR requirements in the next steps.

2.4.2.3 Polymerase Chain Reaction (PCR)

Polymerase chain reaction (PCR) is a common laboratory technique used to make many copies (millions or billions) of a particular region of DNA. This DNA region can be anything the experimenter is interested in. For example, it might be a gene whose function a researcher wants to understand, or a genetic marker used by forensic scientists to match crime scene DNA with suspects.

Typically, the aims of PCR is to make enough of the target DNA region that it can be analyzed or used in some other way. For instance, DNA amplified by PCR may be sent for sequencing, visualized by gel electrophoresis, or cloned into a plasmid for further experiments. PCR is used in many areas of biology and medicine, including molecular biology research, medical diagnostics, and even some branches of ecology.

For the steps of PCR, key ingredients of a PCR reaction are *Taq* polymerase, primers, template DNA, and nucleotides (DNA building blocks). The ingredients are assembled in a tube, along with cofactors needed by the enzyme, and are put through repeated cycles of heating and cooling that allow DNA to be synthesized. The steps of PCR were followed;

1. Denaturation (96°C): Heat the reaction strongly to separate, or denature, the DNA strands. This provides single-stranded template for the next step.
2. Annealing (55-65°C): Cool the reaction so the primers can bind to their complementary sequences on the single-stranded template DNA.
3. Extension (72°C): Raise the reaction temperatures so *Taq* polymerase extends the primers, synthesizing new strands of DNA.

This cycle repeats 23-25 times in a typical PCR reaction, which generally takes 2 – 4 hours, depending on the length of the DNA region being copied. If the reaction is efficient (works well), the target region can go from just one or a few copies to billions. That's because it's not just the original DNA that's used as a template each time. Instead, the new DNA that's made in one round can serve as a template in the

next round of DNA synthesis. There are many copies of the primers and many molecules of *Taq* polymerase floating around in the reaction, so the number of DNA molecules can roughly double in each round of cycling.

2.4.2.4 Amplified fragment length polymorphism (AFLP)

This technique has been widely used for assessing genetic relationship and represents an ingenious combination of RFLP analysis and PCR. This method rapidly generates hundreds of highly replicable markers and allows high resolution genotyping of fingerprinting quality. The time and cost efficiency, reproducibility and resolution of AFLP is superior or equal to those of other markers such as random amplified polymorphism (RAPD), restriction fragment length polymorphism (RFLP) and microsatellites. Because of their high replicability and ease of use, AFLP markers have emerged as a major new type of genetic marker with broad application in systematic, pathotyping, population genetics, and recent plants DNA fingerprinting. AFLP technology is applicable to all organisms without previous sequence information, and generally results in highly informative fingerprints. It rapidly became one of the most popular and powerful approaches to detect DNA polymorphisms [53].

The AFLP markers can be generated for DNA of any organism, and no initial investment in primer/probe development or sequence analysis is required. Partially degraded DNA can be used, but DNA should be highly purified and free of polymerase chain reaction (PCR) inhibitors. Extremely small amounts of DNA (~50 ng) are digested with two restriction enzymes, and AFLP adaptors are joined (ligated) to these ends. Adaptor ligations are performed in the presence of restriction enzymes such that any fragment-to-fragment ligations are immediately recleaved by the restriction enzyme. The adaptor is designed so that ligation of a fragment to an adaptor does not reconstitute the restriction site. The end sequences of each adapted fragment now consist of the adaptor sequence (in red) and the remaining part of the restriction sequence (in blue and green). These known end sequences serve as priming sites in the subsequent AFLP [54]. The AFLP method were shown in **Figure 2.11**.

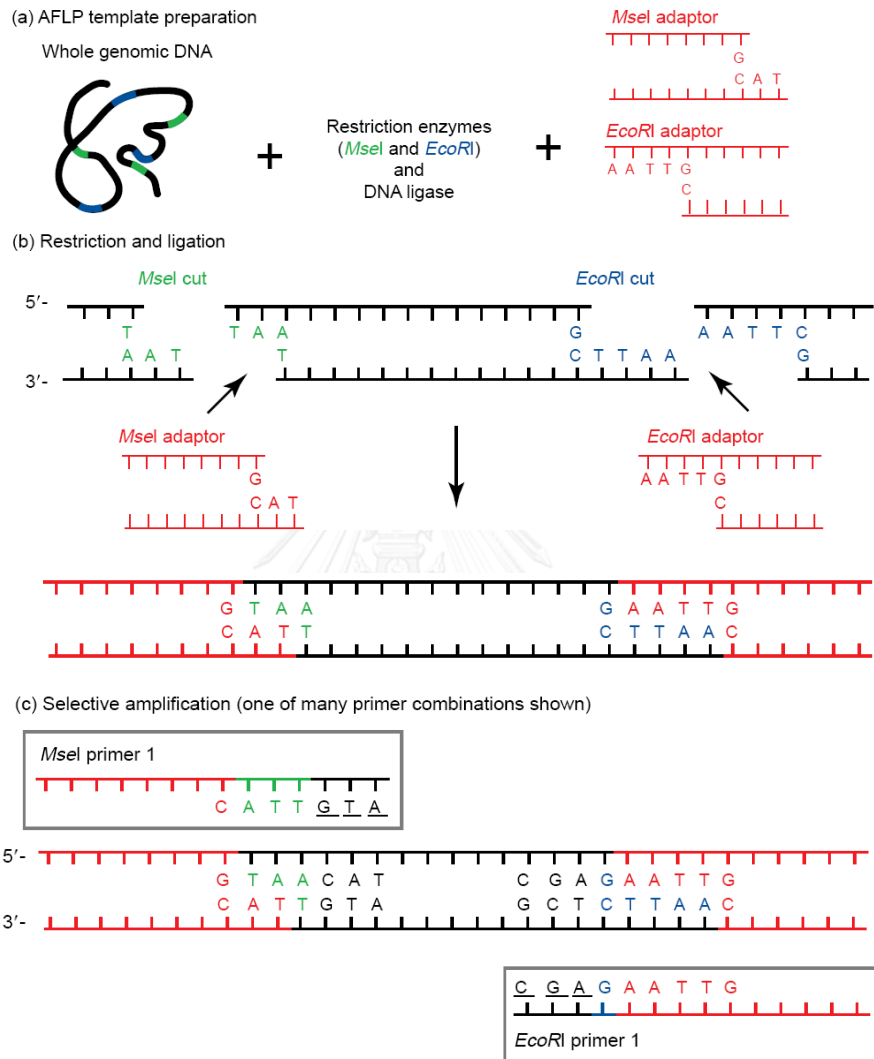

Figure 2.11 Generating amplified fragment length polymorphism (AFLP) markers

Selective amplification depending on genome size, restriction-ligation generates thousands of adapted fragments. For visualization after electrophoresis, only a subset of these fragments is amplified. To achieve selective amplification of a subset of these fragments, primers are extended into the unknown part of the fragments [underlined base pairs (bp), usually one to three arbitrarily chosen bases beyond the restriction site (c, in black). A primer extension of one, two or three bases reduces the number of amplified fragments by factors of 4, 16 and 64, respectively.

AFLP protocols incorporate two amplifications to minimize artifacts. The first step is performed with a single-bp extension, followed by a more selective primer with up to a 3-bp extension. Because of the high selectivity, primers differing by only a single base in the AFLP extension amplify a different subset of fragments. Ideal extension lengths will vary with genome size and will result in an optimal number of products (bands), not too many bands to cause smears or high levels of band comigration during electrophoresis, but sufficient to provide adequate information. By using combinations of primers with different extensions, a series of AFLP amplifications can thus screen a representative fraction of the genome.

For the scoring AFLP markers, AFLP products can be separated and scored with a variety of techniques, ranging from the simple agarose gel electrophoresis to automated genotyping. The polyacrylamide gel electrophoresis (manual or with an automated sequencer) provides maximum resolution of AFLP banding patterns to the level of single-nucleotide length differences, whereas fragment length differences of less than ten nucleotides are difficult to score on agarose gels. Although agarose gels provide the least resolution, they are user-friendly, inexpensive and require minimal equipment.

AFLP is very reliability method because this technique is dominant, multilocus markers are scored as present or absent, artifactual amplification (or amplification failure) of a fragment will reduce AFLP reliability. Artifactual presence/absence of a band probably originates at the restriction-ligation step. For this step, it is crucial to ensure complete digestion (to prevent later amplification of uncut fragments); complete digestion is achieved by the use of high-quality DNA and an excess of restriction enzyme. Enzymes that are sensitive to DNA methylation can also cause

incomplete digestion. PCR-generated artifacts are minimized by the high stringency (high annealing temperature) permitted by the long AFLP primers. High stringency ensures that the primer anneals only to perfectly matched template sequences and eliminates mispriming [55].

This technique is widely used for genetic diversity studies, because it shows significantly polymorphism and reliable for molecular genetic marker. AFLP fingerprinting analysis has been used to authenticate between accession, genetic diversity and phylogenetic relationships of medicinal plant such as *Brassica oleracea* [56], *Cereus* spp. [57], Thai bananas [57], *Calathea* spp. [58], *Boesenbergia* spp. [59] and *Erythroxyllum* taxa [60].



CHAPTER III

MATERIAL AND METHODS

This study included pharmacognostic evaluation (macroscopic and microscopic examination) and molecular analysis (AFLP fingerprinting and phylogenetic relationship) of selected genera *Eurycoma*, *Erythroxylum* and *Tinospora* endemic to Thailand. Materials and methods were described as follows;

3.1 Macroscopic examination

3.1.1 Plant samples

Fresh mature leaves of seven species of selected genera *Eurycoma*, *Erythroxylum* and *Tinospora* were collected from various locations in Thailand. Plant specimens were authenticated by Assoc. Prof. Dr. Nijsiri Ruangrungsi, College of Public Health Sciences, Chulalongkorn University, Thailand. Plants were compared with the herbarium specimens at Forest Herbarium Thailand (BKF) and Museum of Natural Medicines, Faculty of Pharmaceutical Sciences, Chulalongkorn University. Voucher specimens were deposited at College of Public Health Sciences, Chulalongkorn University, Bangkok, Thailand.

3.1.2 Morphological characteristics

Morphological characters of plant samples were studied on the basis of the sensory characteristics. For the whole plant, samples were used for identify their morphology that composed of stem, leaf, flower, fruit, root and another parts. Morphological studies such as shape, size, apex, surface, base, margin, venation, taste, odour and color were carried out. Whole plants were illustrated by hand drawing based on their botanical morphology in proportional scale related to their original size.

3.2 Microscopic Examination

The constant numbers and transverse sections were used as character for identification concerning their constants value in each species. The individual of each samples were observed through the photomicroscope with an appropriated magnification (10X, 20X and 40X).

3.2.1 Preparation of plant samples

The pieces of leaves from the middle of the lamina (midway between the midrib and margin) were cut into small fragment (1 cm²) and soaked in sodium hypochlorite solution until chlorophyll was removed and then the fragments were rinsed with distilled water at least 2 times for cleaning. For rapid removing of many common cell contents, the fragments were cleared by gently warming in chloral hydrate solution (chloral hydrate:distilled water, 8:2) until leaf fragments were more transparent and reveals details of other characteristics. When the leaf fragments were cleared, rinsed with distilled water at least 2 times and finally kept in 50% glycerin to maintain the structure on glass slide for examination under the microscope.

3.2.2 Anatomical character

3.2.2.1 Transverse section of leaves

Plant samples were determined by using transverse section of leave in each species. For preparation of leaves, the representative pieces of plant samples to be examined were selected. Fresh mature leave of plant samples were cleaned and transverse sections were prepared by cutting into suitable piece from the midrib with small portion of lamina by hand section rapidly and smoothly with a sharp razor blade. The section was mounted with water on glass slide and cover slip was placed over the slide. The slide was examined by the microscopic inspection as describe under appropriated magnification (10X, 20X and 40X). Then the different structure of cells such as epidermal cell, parenchyma, sclerenchyma, collenchyma, xylem and phloem were expressed the cell characteristics by hand drawing in the proportion size.

3.2.3 Leaf measurement

The transparent leaf fragments were determined for the stomatal type and leaf constant numbers as a stomatal number, stomatal index, palisade ratio, epidermal cell number and epidermal cell area. Leaf measurement was examined using some modification according to the method as described by Evans [6]. Thirty fields which were representative plant areas of photographs were determined in constant values. The area of each photographs were calculated in square millimeter using Axio Vision program then recorded and were presented in mean, minimum, maximum and standard deviations.

3.2.3.1 Stomatal types

The transparent leaf fragment was mounted and investigated under the microscope with 40X objective lens magnification and 10X eyepiece lens. The photograph of stomatal cell was captured and record of stomatal type based on their form and arrangements in the surrounding cells.

3.2.3.2 Stomatal number

The cleared leaf fragment was mounted and investigated under a microscope with 20X objective lens magnification and 10X eyepiece lens. The photograph was captured and scale of 0.25 mm^2 was applied to the image and the stomata presented in the area of 0.25 mm^2 were counted. The epidermal cells and stomata that located half outside the area of scale were counted only half of 0.25 mm^2 . The stomatal number per square millimeter was calculated by multiplying the number of stomata in 0.25 mm^2 by 4.

3.2.3.3 Stomatal index

The stomatal index was defined as the percentage of stomata from the total number of epidermal cells present in the area of square millimeter. The cleared leaf fragment was mounted and examined under the microscope with 20X objective lens magnification and 10X eyepiece lens. The photograph was captured and scale of 0.25 mm^2 was applied to the image and the stomata presented in the area of 0.25 mm^2 were counted. The epidermal cells and stomata that located half outside the area of

scale were counted only half of 0.25 mm^2 . The stomatal index was calculated as follows;

$$\text{Stomatal index} = [(S \times 100) / (S + E)]$$

Where S is the number of stomata in a given area of leaf and E is the total number of epidermal cells of leaf. The stomatal index per square millimeter was calculated by multiplying the stomatal index in 0.25 mm^2 by 4.

3.2.3.4 Palisade ratio

The cleared leaf fragment was mounted and investigated under the microscope with a 20X objective lens magnification and 10X eyepiece lens. The photograph was captured and scale of 0.25 mm^2 was applied to the image and the palisade cells presented in the area of 0.25 mm^2 were counted. Palisade ratio was examined by counting the number of palisade cells beneath 4 contiguous epidermal cells, then divided by 4 gave the palisade ratio of that group. The palisade cells were beneath half outside the epidermal cell were counted only 2 contiguous epidermal cells.

3.2.3.5 Epidermal cell number

The cleared leaf fragment in upper surface was mounted and investigated under the microscope with a 20X objective lens magnification and 10X eyepiece lens. The photograph was captured and scale of 0.25 mm^2 was applied to the image and the epidermal cells presented in the area of 0.25 mm^2 were counted. The epidermal cells number that located half outside the area of scale were counted only half of 0.25 mm^2 . The epidermal cell number per square millimeter was calculated by multiplying the number of epidermal cell in 0.25 mm^2 by 4.

3.2.3.6 Epidermal cell area

The epidermal cell area was calculated as follows; 1 mm^2 divided by the number of epidermal cell per square millimeter.

3.3 Molecular evaluation

The present study utilized the primers combination and the polymorphic bands were generated by using Amplified Fragment Length Polymorphism (AFLP) technique. The AFLP amplification bands showed a species-specific band of selected genera *Eurycoma*, *Erythroxylum* and *Tinospora* for DNA fingerprinting and authentication of plant materials. In addition, AFLP binary data was used for studying the genetic selected plant samples in this study.

3.3.1 Plant materials

The fresh young leaves of two *Eurycoma* species (*Eurycoma longifolia* Jack and *Eurycoma harmandiana* Pierre) in family Simaroubaceae, three *Erythroxylum* species (*Erythroxylum novogranatense* (Morris) Hieron, *Erythroxylum cambodianum* Pierre and *Erythroxylum cuneatum* (Miq.) Kurz in family Erythroxylaceae and two *Tinospora* species (*Tinospora crispa* (L.) Miers ex Hook.f.& Thomson and *Tinospora baenzigeri* Forman in family Menispermaceae and outgroup plant (*Strychnos nux-vomica*) in family Loganiaceae were used in this study.

Plant samples were collected from various locations in Thailand. *E. longifolia* from Prachin Buri (Location 1; ELO-1), Surat Thani (Location 2; ELO-2) and Ratchaburi (Location 3; ELO-3). *E. harmandiana* from Det Udom, Ubon Ratchathani (Location 1; EHA-1), Trakan Phuet Phon, Ubon Ratchathani (Location 2; EHA-2) and Buntharik, Ubon Ratchathani (Location 3; EHA-3). *E. novogranatense* from Bangkok (Location 1; ENO-1), Nonthaburi (Location 2; ENO-2) and Chiang Mai (Location 3; ENO-3). *E. cambodianum* from Don Mot Daeng, Ubon Ratchathani (Location 1; ECA-1), Det Udom, Ubon Ratchathani (Location 2; ECA-2) and Bungkan (Location 3; ECA-3). *E. cuneatum* from Songkhla (Location 1; ECU-1) and Hat Yai, Songkhla (Location 2; ECU-2). *T. crispa* from Bangkok (Location 1; TCR-1), Phetchaburi (Location 2; TCR-2) and Pathum Thani (Location 3; TCR-3). *T. baenzigeri* from Bangkok (Location-1; TBA 1), Pathum Thani (Location 2; TBA-2) and Nakorn Phatom (Location 3; TBA-3).

Plant specimens were authenticated by Assoc. Prof. Dr.Nijsiri Ruangrangsri, College of Public Health Sciences, Chulalongkorn University, Thailand. Plants were comparing with the herbarium specimens at Forest Herbarium Thailand (BKF) and

Museum of Natural Medicines, Faculty of Pharmaceutical Sciences, Chulalongkorn University. Voucher specimens were deposited at College of Public Health Sciences, Chulalongkorn University, Thailand.

3.3.2 Genomic DNA Extraction

For genomic DNA extraction, fresh young leaves (50-100 mg) were ground in mortar with liquid nitrogen. Then the powder was transferred into clean microcentrifuge tubes and then 700 μ l of CTAB buffer (2% w/v CTAB, 100 mM Tris-HCL pH 8.0, 20 mM EDTA, 1.4 M NaCl) was added, incubated at 65 $^{\circ}$ C for 1 hour in water bath. After incubation, cell debris was spun down by at 13,000 rpm for 10 minutes. After that, transfer the supernatant to new microcentrifuge tubes and 600 μ l of chloroform was added to each tube, mixed the solution by vortexing. After mixing, microcentrifuge tube were centrifuged at 13,000 rpm for 10 minutes and then transfer the upper aqueous phase to new microcentrifuge tube. Next step, 600 μ l of chloroform/isoamyl alcohol (24:1) were added to each tube and mix the solution by vortexing. Then mixing and spin the tubes at 13,000 rpm for 10 minutes. Transfer the upper aqueous phase to a new microcentrifuge tube. After that, 1:10 volume of 3M sodium acetate pH 5.0 was added to each tube followed by adding 2 volume of cold absolute ethanol. Invert the tubes slowly several times to precipitate the DNA and incubated at -20 $^{\circ}$ C for 1 hour. After precipitation, microcentrifuge tubes were centrifuged at 13,000 rpm for 10 minutes and supernatant was removed. The precipitate DNA was stucked at the bottom of the tube and washed with 1 ml of 70% cold ethanol, gently inverted the tube and centrifuged at 13,000 rpm for 10 minutes. The supernatant was smoothly removed and DNA pellet was allowed to dry at room temperature. Finally, the DNA was resuspended in 100 μ l or optimal volume of TE buffer (1 mM EDTA, 10 mM Tris-HCL pH 8.0) by gentle mixing and stored at -20 $^{\circ}$ C. The quantity and quality of genomic DNA was determined by spectrophotometry and 1% agarose gel electrophoresis.

3.3.3 AFLP Procedure

The AFLP procedure was carried out as described by Vos *et al* [55] with a few modifications. It can be divided into the following steps: (1) DNA digestion with two different restriction enzymes (generally a rare and a frequent cutter), (2) ligation of double-stranded adapters to the ends of the restriction fragments, (3) optional DNA preselective amplification of ligated product directed by primers complementary to adapter and restriction site sequences, and (4) DNA amplification of subsets of restriction fragments using selective AFLP primers.

3.3.3.1 Digestion of genomic DNA

Approximately 100 ng/ μ l of genomic DNA were digested with both restriction enzymes (*Eco*RI and *Tru*9I) in 10X buffer A (Roche). The digested reaction was incubated at 37 °C for 1 hours. The digested products were investigated by 1% agarose gel electrophoresis in 0.5X TBE buffer using 5.0 μ l of digested products. The reaction mixture for genomic DNA digestion was performed in **Table 3.1**.

Table 3.1 Preparation of reaction mixture for digesting genomic DNA

Digestion component	Stock concentration	Final concentration	Final volume
gDNA	100 ng/ μ l	500 ng	5 μ l
<i>Eco</i> RI (Boehringer, Germany)	10 U/ μ l	5 U	0.5 μ l
<i>Tru</i> 9I (Roche, Germany)	10 U/ μ l	5 U	0.5 μ l
10X buffer A (Roche, Germany)	10X	1X	4 μ l
ddH ₂ O			30 μ l
		Total	40 μ l

3.3.3.2 Ligation of genomic DNA

After digestion of genomic DNA, the digested genomic DNA fragment was ligated with *EcoRI* adapter and *Tru9I* adapter by adding 10 μl of ligation master mix (Table 3.3). The reaction was incubated at 37 °C for 3 hours or overnight. The ligated products (5.0 μl) was investigated by 1% agarose gel electrophoresis in 0.5X TBE buffer. Each ligated products were diluted as ten-folded with ddH₂O and stored at -20 °C (Table 3.2).

Table 3.2 Reaction mixture for ligation of *EcoRI* and *MseI* adapters

Ligation component	Stock concentration	Final concentration	Final volume
ER adapter (Eurofins MWG Operon, Germany)	5 pmol/ μl	5 pmol	1 μl
MS adapter (Eurofins MWG Operon, Germany)	50 pmol/ μl	50 pmol	1 μl
T4 DNA ligase (NEB, United Kingdom)	5 U/ μl	1 U	0.2 μl
dATP (Fermantas, Canada)	10mM	1 mM	1 μl
10X ligase buffer (NEB, United Kingdom)	10X	1X	1 μl 5.8 μl
ddH ₂ O			
		Total	10 μl

Table 3.3 Sequences of adapters and primers used for AFLP analysis

Type	Name/Abbreviation	Sequence (5' --- 3')
Adapter	<i>Eco</i> RI-adapter	CTC GTA GAC TGC GTA CC CTG ACG CAT GGT TAA
	<i>Mse</i> I-adapter	GAC GAT GAG TCC TGA G TAC TCA GGA CTC AT
Primer +1	ER1 A	AGA CTG CGT ACC AAT TCA
	MS1 C	GAT GAG TCC TGA GTA AC
Primer +3	ER3 AAC	AGA CTG CGT ACC AAT TCA AC
	ER3 AAG	AGA CTG CGT ACC AAT TCA AG
	ER3 ACC	AGA CTG CGT ACC AAT TCA CC
	ER3 AGC	AGA CTG CGT ACC AAT TCA GC
	ER3 AGG	AGA CTG CGT ACC AAT TCA GG
	MS3 CAA	GAT GAG TCC TGA GTA ACA A
	MS3 CAC	GAT GAG TCC TGA GTA ACA C
	MS3 CAG	GAT GAG TCC TGA GTA ACA G
	MS3 CAT	GAT GAG TCC TGA GTA ACA T
	MS3 CCA	GAT GAG TCC TGA GTA ACC A
	MS3 CGG	GAT GAG TCC TGA GTA ACG G
	MS3 CGT	GAT GAG TCC TGA GTA ACG T

3.3.3.3 Preselective amplification

Five microliter of diluted ligation products were amplified with primer combinations (ER1A and MS1C). Each reaction was composed of 20 µl preselective amplification primer mixture. PCR was performed in a PCR Thermal Cycle (Applied Biosystem, USA) and used the following pre-selective PCR program as followed;

1.	Pre-denaturation	94 °C	5	min	
.....					
2.	Denaturation	94 °C	30	sec	
	Annealing	56 °C	1	min	20 cycles
	Extension	72 °C	1	min	
.....					
3.	Final Extension	72 °C	10	min	

The pre-amplification PCR products were diluted to ten-folded with ddH₂O, then mixed and stored at -20 °C for next selective amplification step (**Table 3.4**).

Table 3.4 Reaction mixture for preselective amplification reaction

Pre-selective PCR product	Stock concentration	Final concentration	Final volume
gDNA (ligation product)			5 µl
MgCl ₂	50 mM	1.5 mM	1.5 µl
dNTPs	1 mM	0.2 mM	10 µl
ER1 A	70 ng/µl	1.4 ng/µl	1 µl
MS1 C	70 ng/µl	1.4 ng/µl	1 µl
<i>Taq</i> DNA polymerase	50 U/µl	1 U	0.2 µl
PCR buffer	10X	1X	5 µl
ddH ₂ O			26.3 µl
		Total	50 µl

3.3.3.4 Selective amplification

Three microliters of diluted pre-selective amplified products were used for selective amplification in a reaction tube containing 20 µl selective amplification primer mixture (**Table 3.5**). The primer+3 combination were used for selective amplification and mixtures of selective amplification were performed as following selective PCR program.

1. Pre-denaturation 95 °C 2 min

2. Denaturation 95 °C 30 sec

Annealing 65 °C 30 sec

Extension 72 °C 1 min

Annealing were initiated at a temperature of 65 °C, which will be then reduced by 0.7 °C for the next 12 cycles and maintained at 56 °C for 30 sec subsequent 23 cycles.

3. Final Extension 72 °C 1 min

After selective amplification step, 10 µl of sequencing dye was added to selective amplified products and determined by using 1% agarose gel electrophoresis in 0.5X TBE buffer. The selective amplified products were performed on denaturing 6% denaturing polyacrylamide gel electrophoresis.

Table 3.5 Reaction mixture for selective amplification reaction.

Selective PCR product	Stock concentration	Final concentration	Final volume
Pre-amplification PCR products			2 µl
MgCl ₂	50 mM	1.5 mM	0.6 µl
dNTPs	1 mM	0.2 mM	4 µl
ER3 A _ _	30 ng/µl	1.5 ng/µl	1 µl
Ms3 C _ _	30 ng/µl	1.5 ng/µl	1 µl
Taq DNA polymerase	5 U/µl	0.5 U	0.1 µl
PCR buffer	10X	1X	2 µl
ddH ₂ O			9.3 µl
		Total	20 µl

3.3.3.5 Detection of AFLP band patterns

3.3.3.5.1 Denaturing Polyacrylamide gel electrophoresis

The electrophoresis was performed in 6% denaturing polyacrylamide gel. The selective PCR products were added an equal volume of formamide loading dye and heated for 5 min at 94 °C. After that, the reaction was performed in 1X TBE buffer by a Sequi-GEN GT Sequencing (Biorad, USA) at a constant power (50-55W) with temperature below 45 °C.

3.3.3.5.2 Silver staining

The silver nitrate staining was followed the protocol describe by Bassam *et al* [61]. AFLP banding patterns from denaturing 6% polyacrylamide gel electrophoresis was detected by silver nitrate solution as followed; stain in fixative solution (10% acetic acid) for 20 min, washing with ddH₂O 3 times for 2 min, stain in silver nitrate solution (0.1 g silver nitrate, 150 µl 37% formaldehyde, adjust with ddH₂O to 100 ml) for 30 min, washing 3-5 sec, stain in developer solution (0.002 g sodium thiosulphate, 2.5 g sodium carbonate, 54 µl 37% formaldehyde, adjust with ddH₂O to 100 ml) until the DNA fingerprinting was appeared, then stain in stop solution (10% acetic acid) for 5 min and washed for 2 min. Silver-stained gels was scanned on scanner and imaging system.

3.3.3.6 Data analysis

For genetic diversity analysis based on AFLP method, the polymorphic were visually scored as a binary character for its present (1) or absence (0). A genetic similarity matrix was computed according to Jaccard's coefficient. The dendrogram was constructed for cluster analysis from the matrix of similarity coefficients using the Unweighted Pair Group Method with Arithmetic mean (UPGMA) by FreeTree software. For the reliability of the tree generated, dendrogram was evaluated with the bootstrap analysis of 1,000 of sampling with replacements.

3.4 Standardization parameters of *Eurycoma longifolia* root crude drug

Plant materials were examined by macroscopic examination due to a quality of crude drug according to World Health Organization (WHO) guideline standard methods.

3.4.1 Macroscopic examination

The shade dried root of *E. longifolia* were evaluated by surface characteristics, texture, fracture characteristics, appearance of the cut surface, shape, size, color, odor, taste, and other characters. For the whole plant, photographs were taken and described base on botanical morphology.

3.4.2 Microscopic examination

The microscopic appearances of the *E. longifolia* root were examined in cross section and in powdered form. Anatomical characters and histological characters were investigated under photomicroscope observation under objective lens with a 10X, 20X and 40X magnifications and eyepiece lens of 10X magnification on the optical system by microscope and refers to analysis of size, shape and other internal features characteristics and then illustrated by hand drawing for its shape, size and botanical morphology.

3.4.3 Physiochemical parameters

Dried roots of plant *Eurycoma longifolia* Jack were collected from 15 Thai traditional drug stores in 11 provinces in Thailand (1; Chiang Mai, 2; Nakhon Sawan, 3; Nakhon Pathom, 4; Uthai Thani, 5; Ratchaburi, 6; Rayong, 7; Kalain, 8; Nong Khai, 9; Ubon Ratchathani, 10; Surat Thani, 11; Nakhon Si Thammarat, 12; Chaokrompoe, 13; Vejpongosot, 14; Hua Heng and 15; Sapandam). The pharmacognostic specifications included acid insoluble ash, total ash, ethanol-soluble content and water content were determined and presented as mean \pm SD. Thin layer chromatography (TLC) was also evaluated.

After removed of foreign matters, the dried roots were ground and passed through a sieve with mesh number 20, kept in a well-closed container. The constant

numbers due to quality of plant samples were examined by standard methods of the World Health Organization (WHO) guideline [62].

3.4.3.1 Determination of total ash

Three grams of the ground sample were accurately weighed in a pre-weighed crucible and incinerated at 500-600 °C until white, cooled in a desiccators and weighed without delay. The percentage of total ash was calculated with reference to the air-dried crude drug.

3.4.3.2 Determination of acid-insoluble ash

For the crucible containing the total ash, 25 ml of hydrochloric acid were added (70g/l), covered with a watch-glass and boiled gently for 5 minutes. The watch-glass was rinsed with 5 ml of hot water and add this liquid was added to the crucible. The insoluble matter was filtered on an ashless filter-paper and washed with hot water until the filtrate was neutral. The filter-paper containing the insoluble matter was transferred to the original crucible, dried on a hot plate and incinerated again. The residue was allowed to cool in a desiccators and weighed without delay.

3.4.3.3 Determination of ethanol-soluble extractive

Five grams of the ground sample were macerated with 70 ml of 95% ethanol in a closed conical flask for 6 hours in shaking bath, allowed to stand for 18 hours, filtered rapidly to avoid loss of ethanol. Twenty milliliter of the filtrate were evaporated to dryness in pre-weight small beaker and dried with heat to constantly weight.

3.4.3.4 Determination of water-soluble extractive

Five grams of the ground sample were macerated with 70 ml of distilled water in a closed conical flask for 6 hours in shaking bath, allowed to stand for 18 hours, filtered rapidly to avoid loss of ethanol. Twenty milliliter of the filtrate were evaporated to dryness in pre-weighed small beaker and dried with heat to constantly weight.

3.4.3.5 Determination of loss on drying

Five grams of the ground sample were placed in a pre-weighed small beaker and dried with heat at 105 °C to constant weight.

3.4.3.6 Determination of water content

Fifty grams of the ground sample were added with 200 ml of water-saturated toluene and distilled by azeotropic distillation. The water and toluene layers were allowed to separate and the volume of water was recorded.

3.4.3.7 Thin-layer chromatographic identification

One gram of the ground sample was extracted with 20 ml of Methanol by maceration, filtered and evaporated to dryness. The residue was dissolved in 0.5 ml of methanol and 10 µl was applied to the TLC plate coated with silica gel GF254. The chromatogram was developed in the chamber with chloroform:methanol (9:1) as the mobile phase. The produced spots were observed under short-wave (254 nm) and long-wave (365 nm) ultraviolet light and sprayed the spots with the p-anisaldehyde reagent.

CHAPTER IV

RESULTS

In this chapter, the results of the macroscopic, microscopic and molecular evaluation of two *Eurycoma* species, three *Erythroxylum* species and two *Tinospora* species were presented. The standardization of *Eurycoma longifolia* root was also presented.

4.1 Macroscopic evaluation

4.1.1 Morphological characteristics

Macroscopic evaluation of two *Eurycoma* species (*E. longifolia* Jack and *E. harmandiana* Pierre), three *Erythroxylum* species (*E. novogranatense* (Morris) Hieron, *E. cambodianum* Pierre and *E. cuneatum* (Miq.) Kurz) and two *Tinospora* species (*T. crispa* (L.) Miers ex Hook.f. & Thomson and *T. baenzigeri* Forman) were observed and demonstrated by hand drawing in the proportion size related to the original scale.

Morphological characteristics were observed and described as botanical characters. Two *Eurycoma* species were similar in flower, fruit and root, but their leaves and stems were different. The important character of these two species are stem and leaf shape that can be used to identify between these species. The stem of *E. longifolia* was medium-sized and tall, but *E. harmandiana* was a small shrub. The leaf shape of *E. longifolia* was ovate-lanceolate but *E. harmandiana* is linear, rigid and thin. Three *Erythroxylum* species were similar in stem, flower, fruit and seed, but they were different in leaf shape. *E. novogranatense* is obovate, *E. cambodianum* is elliptic or obovate and *E. cuneatum* is obovate or elliptic to elliptic-lanceolate. The important character of these three species are more conspicuous of two longitudinal curved lines (false midrib) on each side of the midrib on the lower face of the leaf. Two *Tinospora* species were similar in flower, fruit and seed, but there were differentiate morphology on stem and leaf. The stem of *T. crispa* was climber and more prominently tuberculate, but *T. baenzigeri* was showed less prominently tuberculate. Leaf shape

of *T. crispa* was cordate but *T. baenzigeri* was cordate or reniform and showed a two node appearing at leaf base.

Whole plant of *E. longifolia* and *E. harmandiana* were shown in **Figure 4.1-4.2** and their morphological characteristics were described in **Table 4.1**. Whole plant of *E. novogranatense*, *E. cambodianum* and *E. cuneatum* were shown in **Figure 4.3-4.5** and their morphological characteristics were described in **Table 4.2**. Whole plant of *T. crispa* and *T. baenzigeri* were shown in **Figure 4.6-4.7** and their morphological characteristics were described in **Table 4.3**.



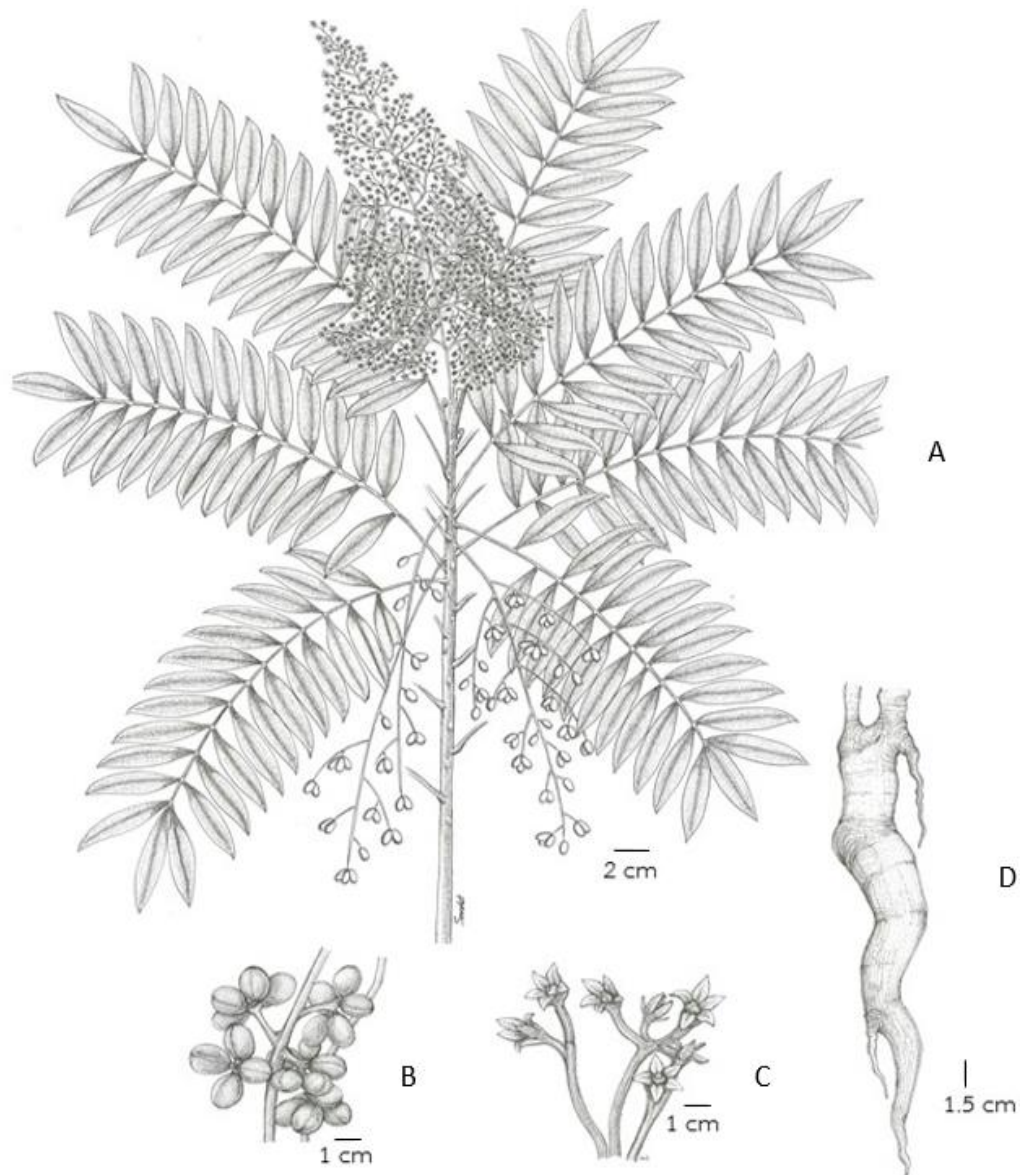

Figure 4.1 Whole plant of *E. longifolia* Jack with inflorescences and fruiting branch (A), fruiting branch (B), flowers (C), and root (D)

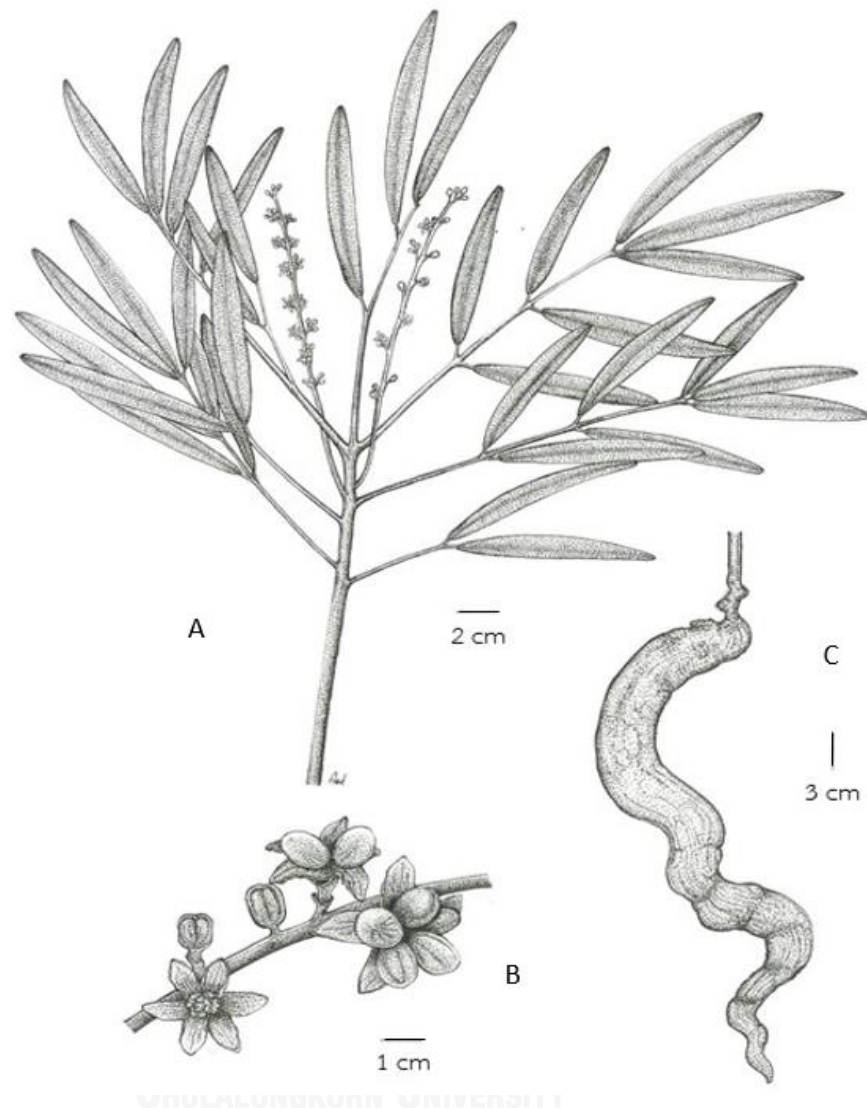

Figure 4.2 Whole plant of *E. harmandiana* Pierre with inflorescences (A), flowers and fruiting branch (B), and root (C)

Table 4.1 Morphological characteristics of *Eurycoma longifolia* and *Eurycoma harmandiana*

Plant part	Morphological characteristics	
	<i>E. longifolia</i>	<i>E. harmandiana</i>
Stem	Medium-sized slender shrub to 3 m, rarely up to 10-15 m tall, dark brown colour	Small shrub to 30 cm, rarely up to 50 cm tall, brownish-black or dark red colour
Leaf	Pinnate, opposite or subopposite, lanceolate to ovate-lanceolate, 20-40 cm long and 1.5-6 cm wide and 3-10 long, entire margin, green colour	Rigid and thin, pinnate with terminal leaflet, linear shape, 5-11 leaflets, 0.3-0.5 cm wide and 3-7 cm long, entire margin, dark green colour
Flower	Dioecious, tiny, reddish-brown colour, inflorescences are densely arranged in a pinnacle of 30-60 cm long, 5-6 small petals with smooth trichomes	Dioecious, tiny, small pink to red colour, inflorescences are densely arranged in a pinnacle of 10-20 cm long, 5-6 small petals with smooth trichomes
Fruit	The drupes are avoid, 1-2 cm long and 0.5-1 cm broad, yellowish brown when young and brownish red when ripe	Fruits are avoid, 1-1.5 cm long and 0.5-1 cm broad, yellowish brown when young and dark red when ripe
Root	Root is pale yellowish colour, 0.5-1.5 m long, 1-10 cm diameters	Root is pale yellowish or gray colour, 15-170 cm long, 1-3 cm diameters

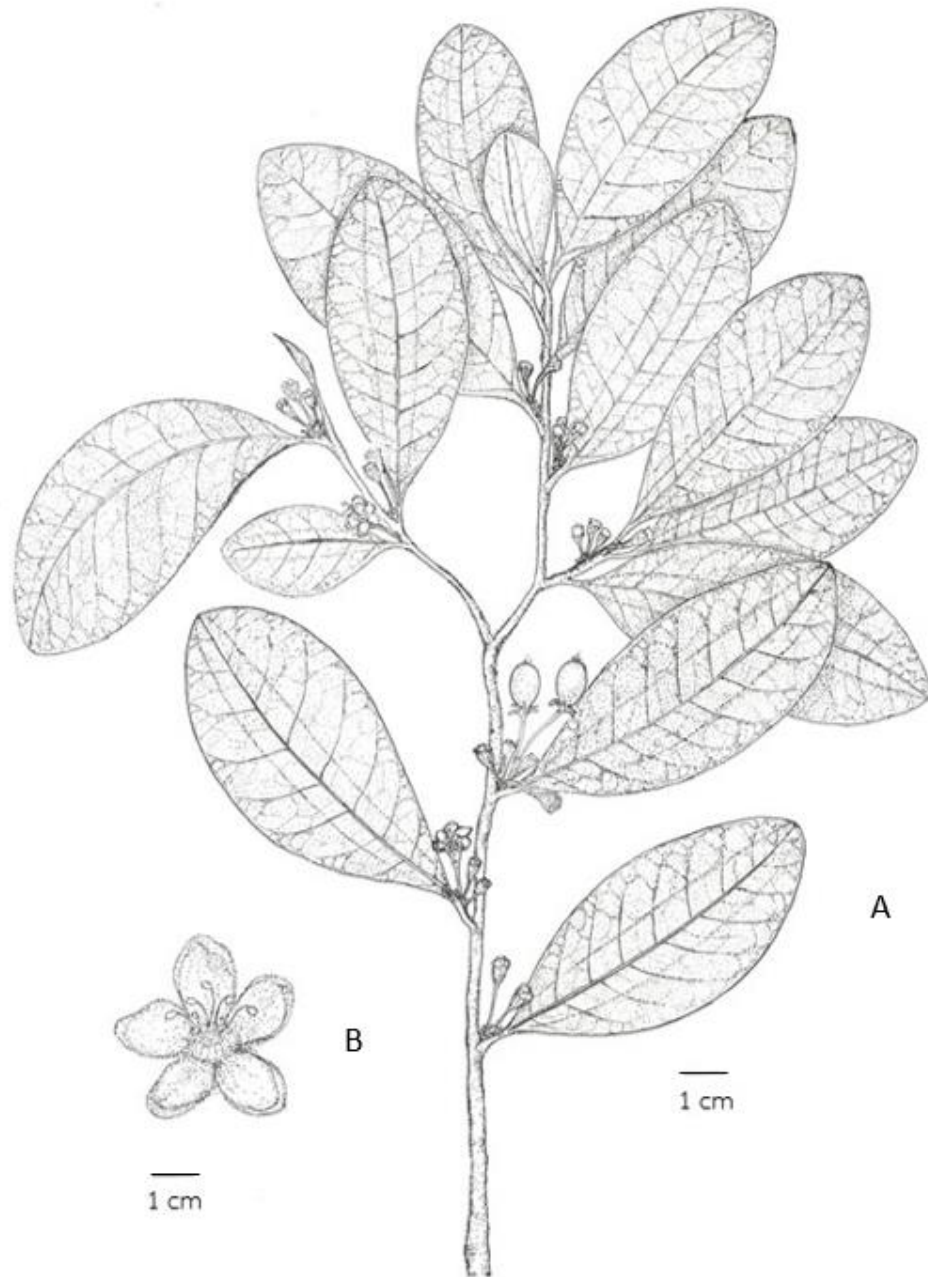

Figure 4.3 Whole plant of *E. novogranatense* with flowers and fruits (A), and flower (B)

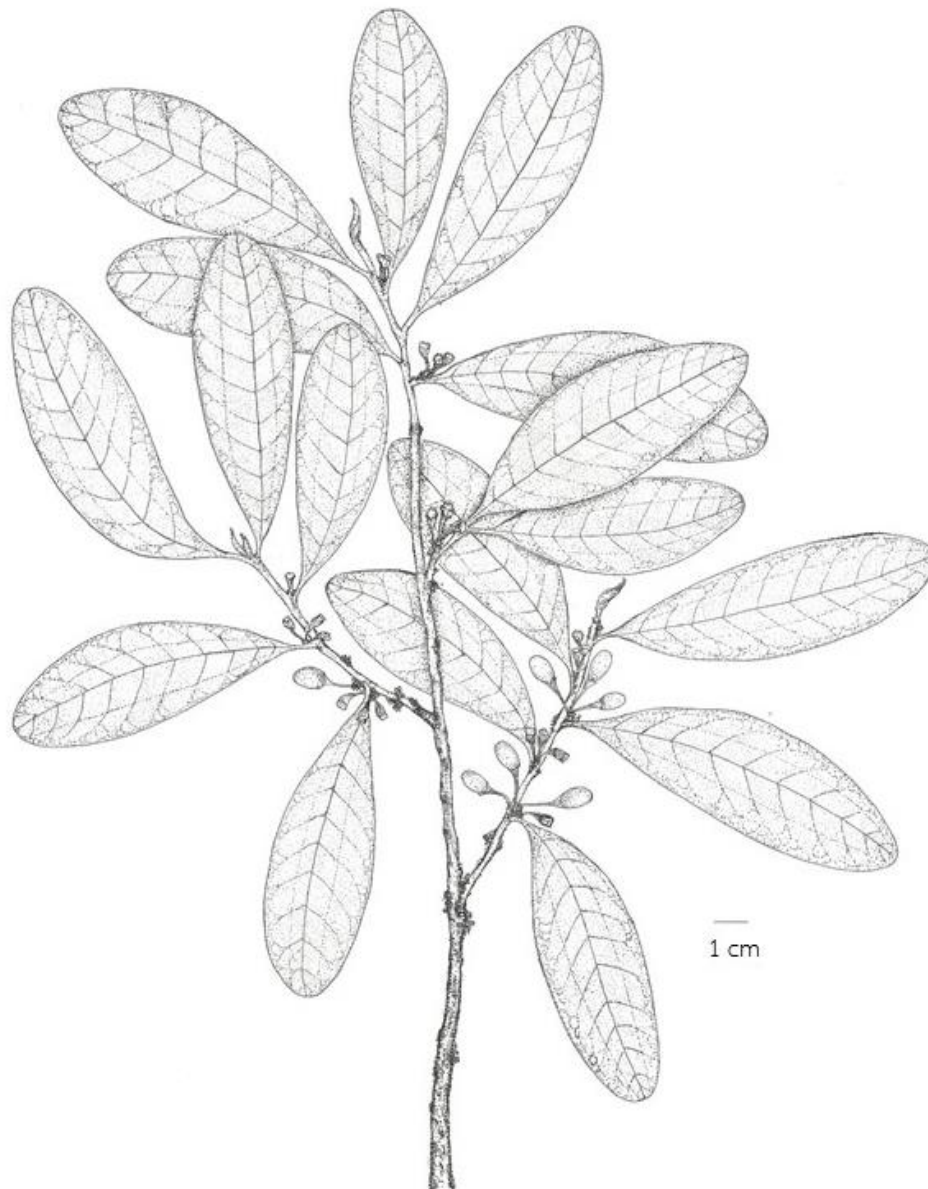

Figure 4.4 Whole plant of *E. cambodianum* with flowers and fruits

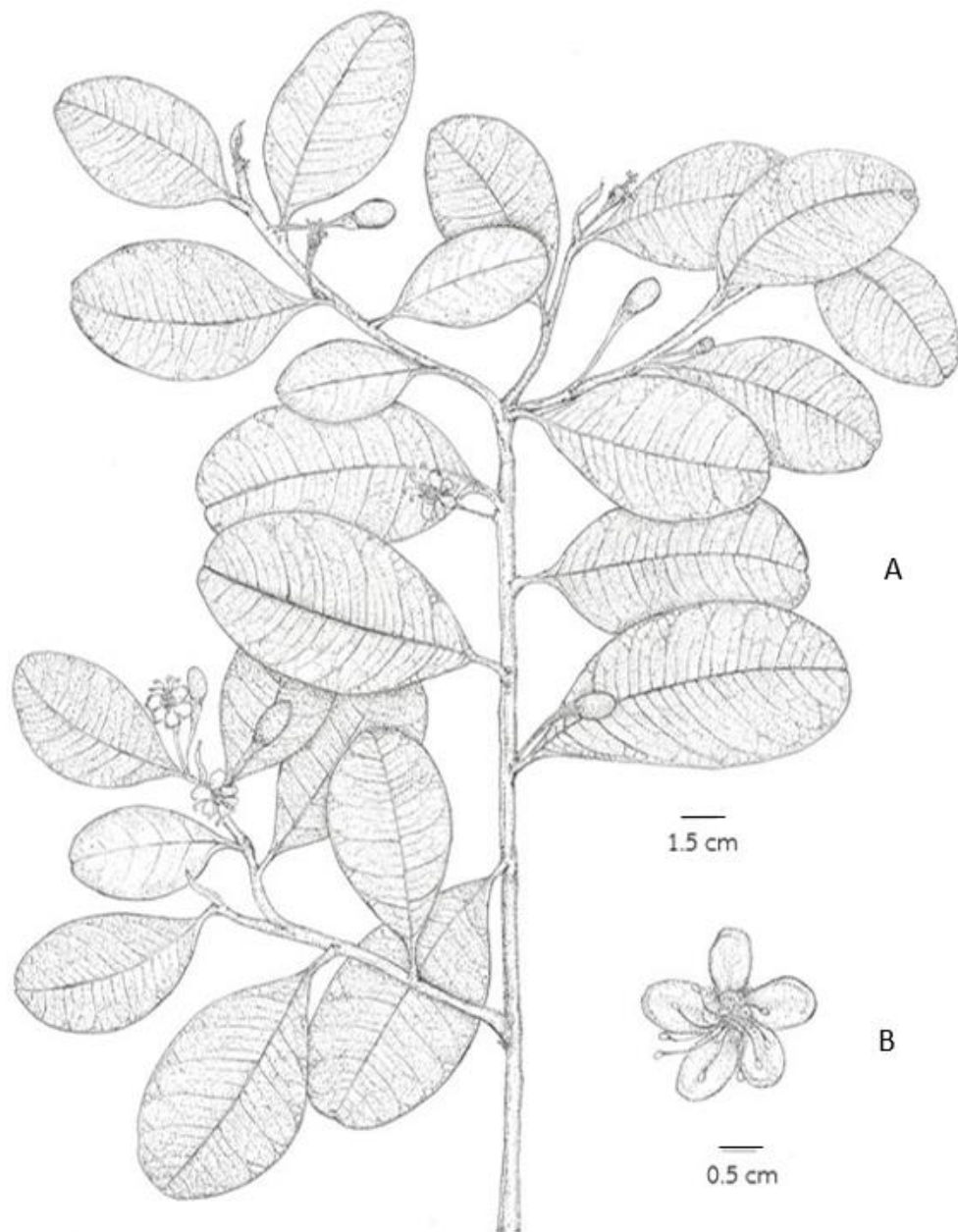

Figure 4.5 Whole plant drawing of *E. cuneatum* with flowers and fruits (A), and flowers (B)

Table 4.2 Morphological characteristics of *Erythroxylum novogranatense*, *Erythroxylum cambodianum* and *Erythroxylum cuneatum*

Plant part	Morphological characteristics		
	<i>E. novogranatense</i>	<i>E. cambodianum</i>	<i>E. cuneatum</i>
Stem	Shrub to 1-2 m tall, brown to black colour	Shrub to 50-90 cm tall, gray to brown colour	Shrub or small tree to 10 m tall, brown to black colour
Leaf	Leaves are thin, obovate shape, alternate, 2-3.5 cm wide and 3-5 cm long, entire margin, more conspicuous of two longitudinal curved lines (false midrib) on each side of the midrib, bright green above	Elliptic or obovate shape, alternate, 2.5-3 cm wide and 10-15 cm long, entire margin, dark green colour, false midrib is even more visible on the under face of the leaf	Obovate or elliptic to elliptic-lanceolate, alternate, 2-3 cm wide and 5-10 cm long, entire margin, dark green to greenish brown above and light green on the underside, false midrib is even more visible on the under face of the leaf
Flower	Flowers are small, and disposed in clusters on short stalks, corolla is composed of five white or yellowish-white petals, 1.5-2 mm wide and 3-5 mm long	Flower in clusters on short stalks, petals white or greenish white to light green, 1.5-2 mm wide and 3-5 mm long, flowers on leafy branches	Flower in clusters of 2-6, calyx lobes triangular to 0.5-1.2 mm long, petals white or greenish white to light green, 1.5-2 mm wide and 3-4 mm long
Fruit	Fruits on leafy branches, elliptical drupe, bright red colour when ripe, curved shape, 3-5 mm wide and 8-12 mm long	Ripening shiny bright red, ellipsoid, curved, triangular, 3-5 mm wide and 8-12 mm long	Ripening shiny bright red, ellipsoid, curved, triangular, 2.5-4.5 mm wide and 8-10 mm long
Seed	Seed in fertile locule, flattened to planoconvex, 1-3 mm wide and 5-9 mm long	Seed in fertile locule, flattened, 1.5-3 mm wide and 6-10 mm long	Seed in fertile locule, flattened, 1-2.5 mm wide and 5-10 mm long

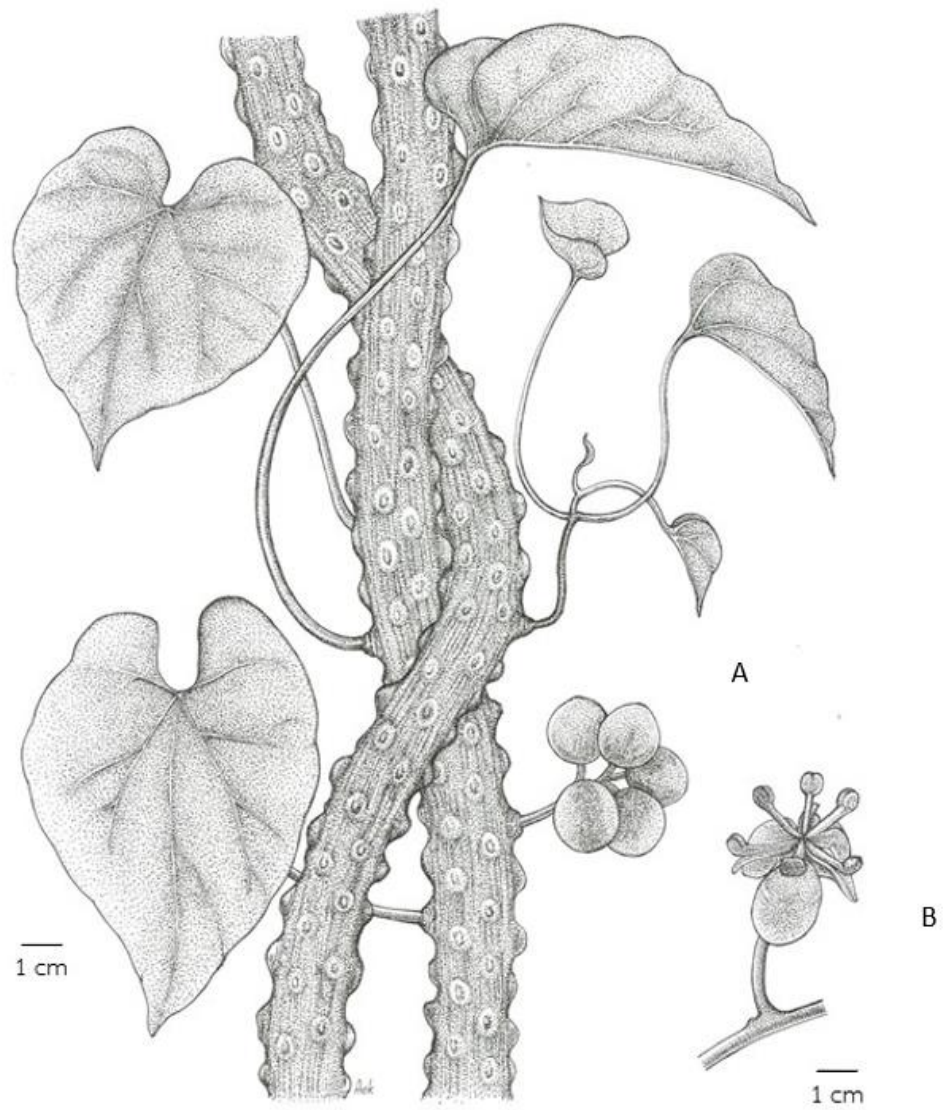

Figure 4.6 Whole plant drawing of *T. crista* with fruits (A), and flowers (B)

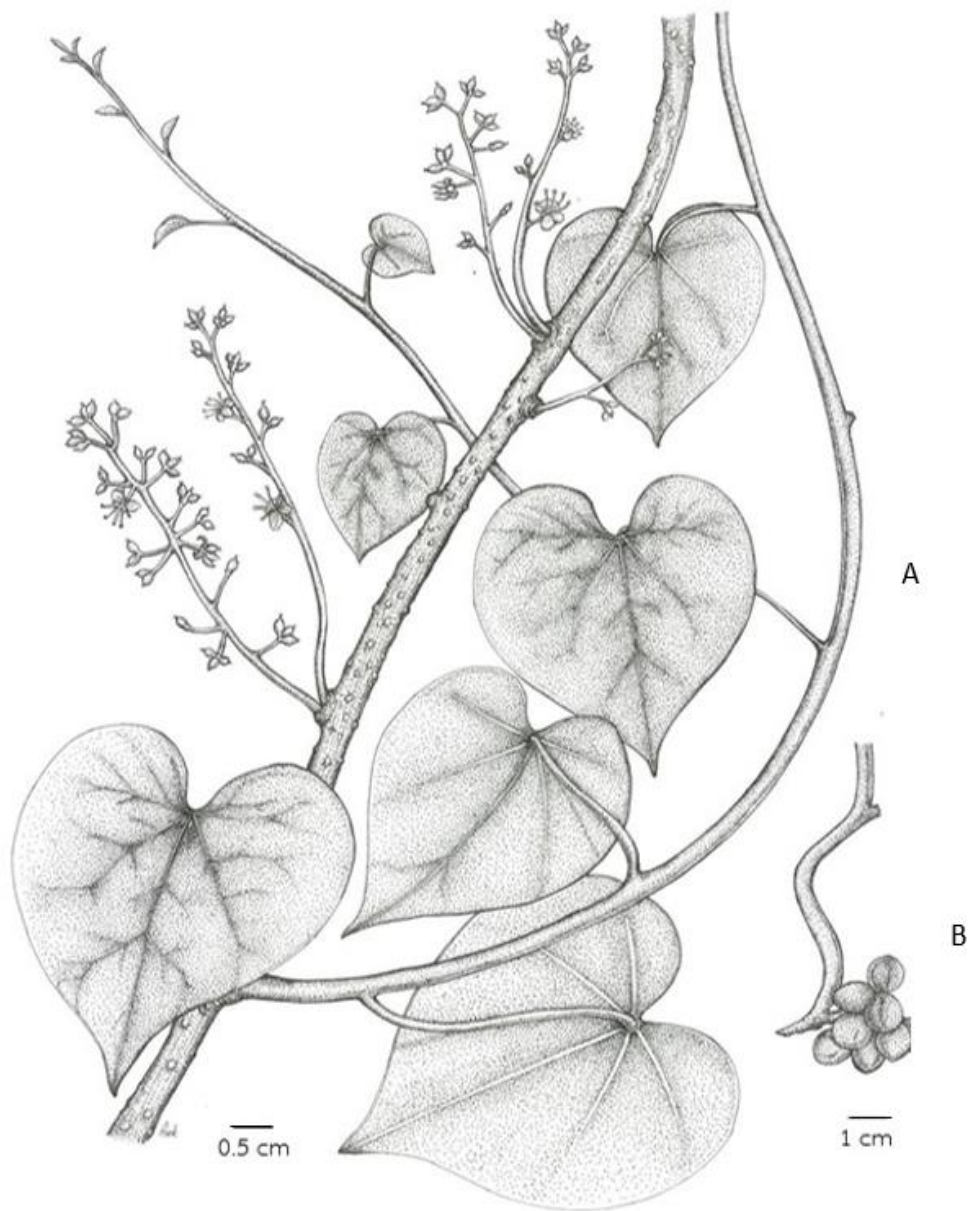

Figure 4.7 Whole plant of *T. baenzigeri* with inflorescences (A), and fructing branch (B)

Table 4.3 Morphological characteristics of *Tinospora crispa* and *Tinospora baenzigeri*

Plant part	Morphological characteristics	
	<i>T. crispa</i>	<i>T. baenzigeri</i>
Stem	Climber and more prominently tuberculate	Climber and less prominently tuberculate
Leaf	Cordate, alternate, caudate apex, entire margin, cordate base and 8-10 cm long petiole	Cordate or reniform, caudate apex, alternate, entire margin, cordate base, 5-7 cm long petiole and two nodes appearing at leaf base
Flower	Inflorescences spike, 3 petals and greenish yellow color	Inflorescence spike, 3 petals and greenish yellow color
Fruit	Ellipsoidal, smooth, 1-2 cm long with dark yellow color	Ellipsoidal, smooth, 1-1.5 cm long with dark yellow color
Seed	Moon seed, rough, 0.5-1 cm long with black color	Moon seed, rough, 0.5-1 cm long with black color

4.2 Microscopic evaluation

Microscopic evaluation of two *Eurycoma* species, three *Erythroxyllum* species and two *Tinospora* species were performed on anatomical character and leaf measurement.

4.2.1 Anatomical character

The transverse sections of leaf midrib of two *Eurycoma* species, three *Erythroxyllum* species and two *Tinospora* species were illustrated.

4.2.1.1 Transverse section of leaf of two *Eurycoma* species

Transverse section of leaf of *Eurycoma longifolia* (Figure 4.8) showed multicellular trichome at both upper and lower epidermis whereas *Eurycoma harmandiana* contained no trichome (Figure 4.9). This character can be used for differentiation of these two species. Moreover, the midrib characteristics including upper and lower epidermis, palisade cell, spongy cell and vascular bundle between *Eurycoma longifolia* and *Eurycoma harmandiana* were absolutely distinguished.

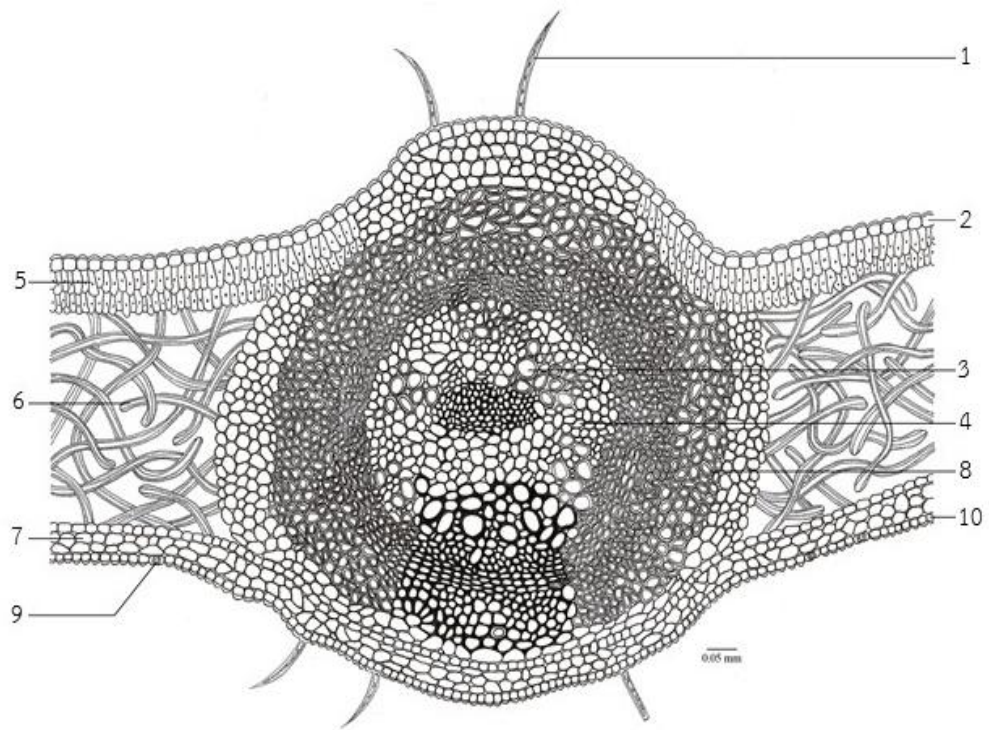

Figure 4.8 Transverse section of leaf midrib of *Eurycoma longifolia*:

(1) Multicellular trichome	(6) Spongy cell
(2) Upper epidermis	(7) Collenchyma
(3) Xylem vessel	(8) Parenchyma
(4) Phloem tissue	(9) Stomata
(5) Palisade cell	(10) Lower epidermis

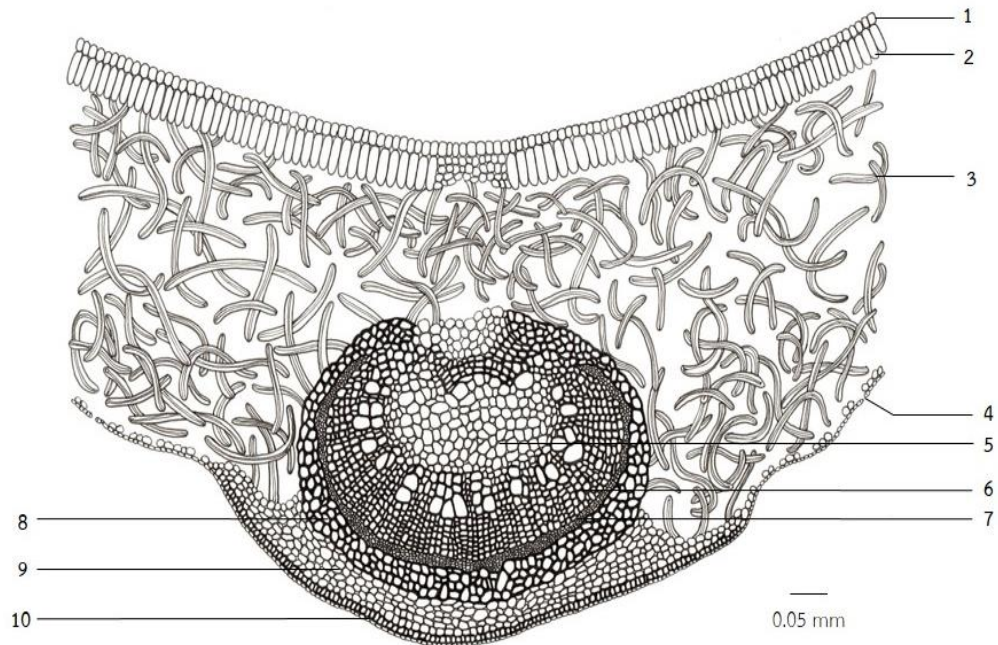

Figure 4.9 Transverse section of leaf midrib of *Eurycoma harmandiana*:

- | | |
|---------------------|----------------------|
| (1) Upper epidermis | (6) Xylem vessel |
| (2) Palisade cell | (7) Phloem tissue |
| (3) Spongy cell | (8) Fiber |
| (4) Stomata | (9) Collenchyma |
| (5) Parenchyma | (10) Lower epidermis |

4.2.1.2 Transverse section of leaf of three *Erythroxylum* species

Transverse section of leaf of *Erythroxylum novogranatense* (Figure 4.10), *Erythroxylum cambodianum* (Figure 4.11) and *Erythroxylum cuneatum* (Figure 4.12) showed distinct characters of epidermis, palisade cell, stomata, spongy cell, parenchyma, xylem vessel, phloem tissue and collenchyma.

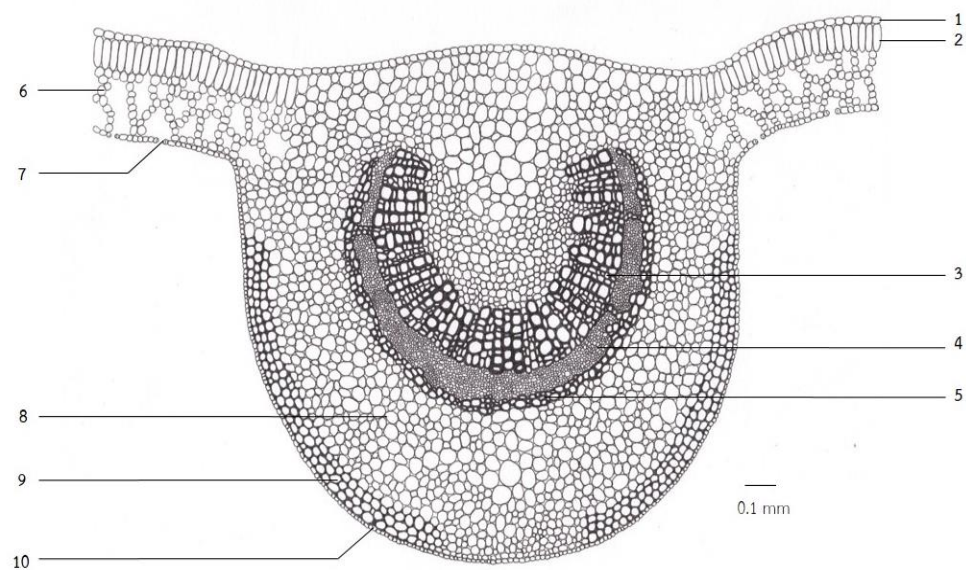

Figure 4.10 Transverse section of leaf midrib of *Erythroxylum novogranatense*:

- | | |
|---------------------|----------------------|
| (1) Upper epidermis | (6) Spongy cell |
| (2) Palisade cells | (7) Stomata |
| (3) Xylem vessel | (8) Parenchyma |
| (4) Phloem | (9) Collenchyma |
| (5) Fiber | (10) Lower epidermis |

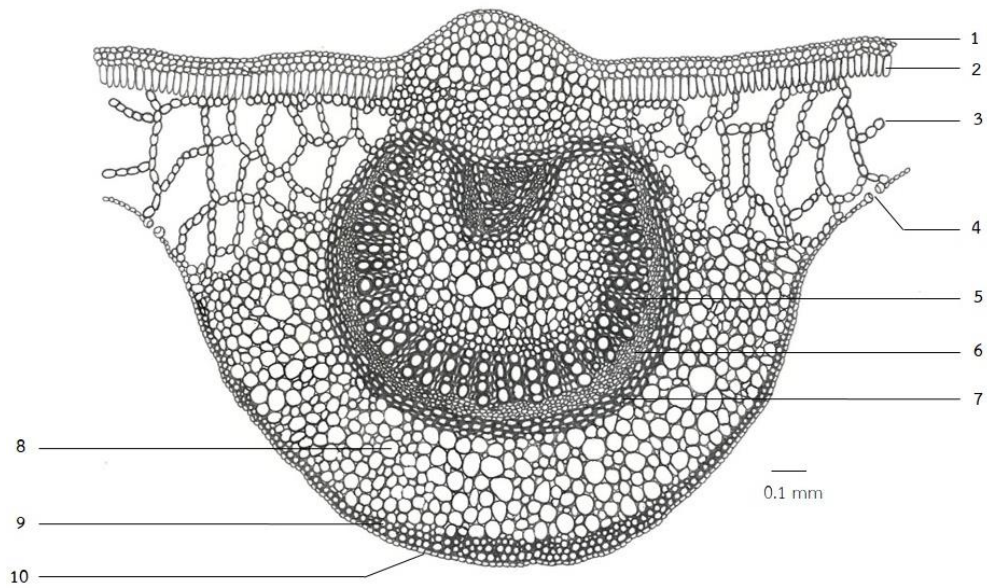

Figure 4.11 Transverse section of leaf midrib of *Erythroxylum cambodianum*:

- | | |
|---------------------|----------------------|
| (1) Upper epidermis | (6) Phloem |
| (2) Palisade cell | (7) Fiber |
| (3) Spongy cell | (8) Parenchyma |
| (4) Stomata | (9) Collenchyma |
| (5) Xylem | (10) Lower epidermis |

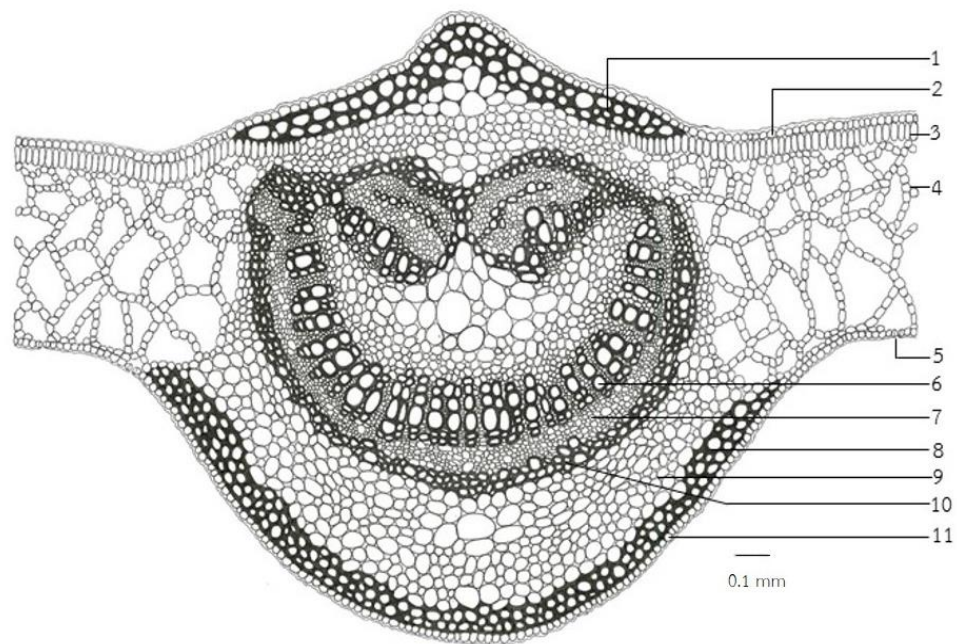

Figure 4.12 Transverse section of leaf midrib of *Erythroxylum cuneatum*:

- | | |
|---------------------------|----------------------------|
| (1) Collenchyma | (7) Phloem vascular tissue |
| (2) Upper epidermis | (8) Collenchyma |
| (3) Palisade cell | (9) Parenchyma |
| (4) Spongy cell | (10) Phloem fiber |
| (5) Stomata | (11) Lower epidermis |
| (6) Xylem vascular tissue | |

4.2.1.3 Transverse section of leaf of two *Tinospora* species

Transverse section of leaf of *Tinospora crispera* and *Tinospora baenzigeri* showed particular characteristics especially their vascular bundle as showed in **Figure 4.13 - 4.14.**

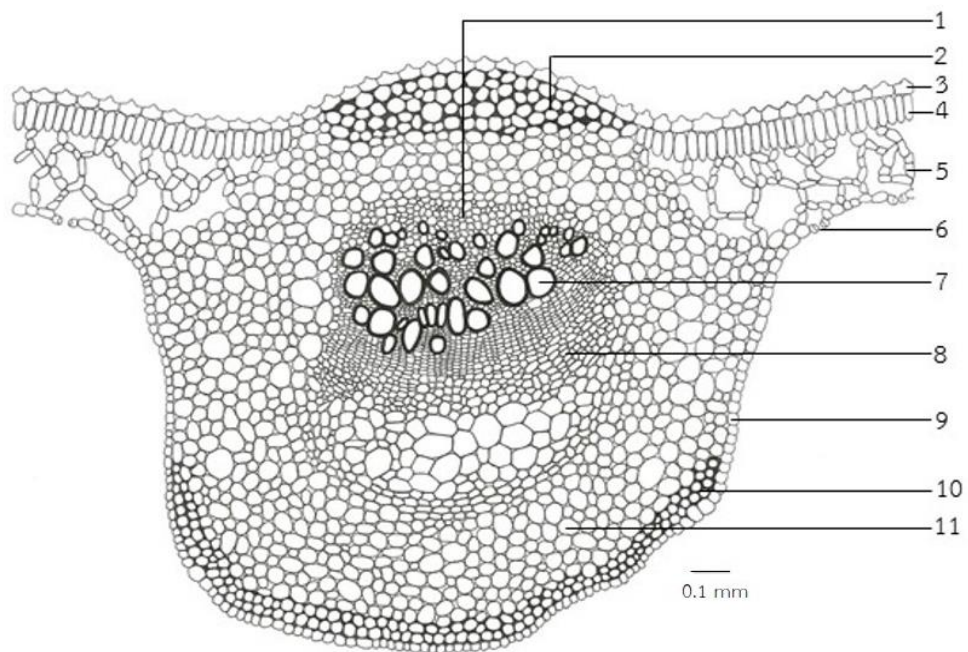

Figure 4.13 Transverse section of leaf midrib of *Tinospora crispera*:

- | | |
|---------------------------|----------------------------|
| (1) Xylem vascular tissue | (7) Vessel member |
| (2) Collenchyma | (8) Phloem vascular tissue |
| (3) Upper epidermis | (9) Lower epidermis |
| (4) Palisade cell | (10) Collenchyma |
| (5) Spongy cell | (11) Parenchyma |
| (6) Stomata | |

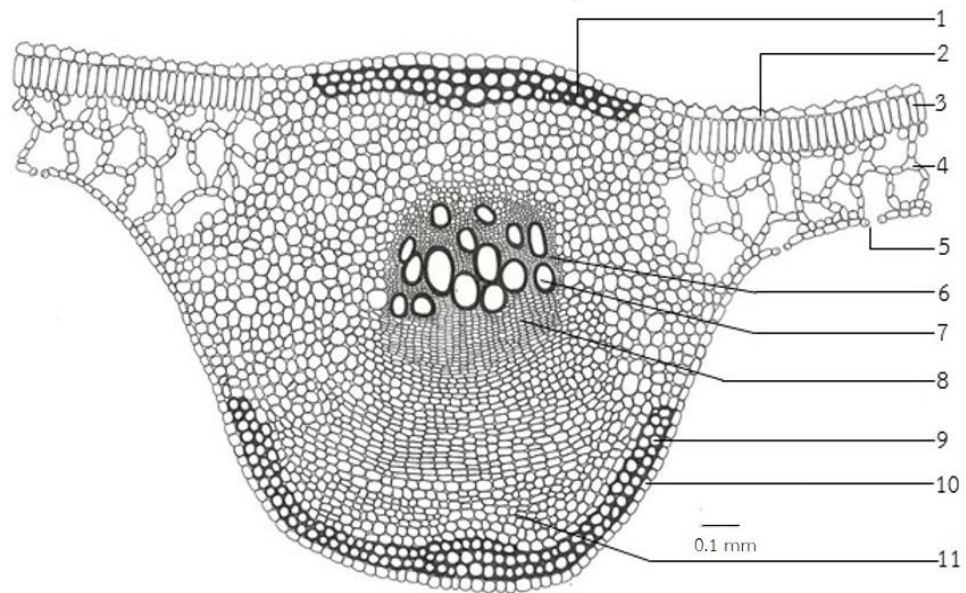

Figure 4.14 Transverse section of leaf midrib of *Tinospora baenzigeri*:

- | | |
|---------------------------|----------------------------|
| (1) Collenchyma | (7) Vessel member |
| (2) Upper epidermis | (8) Phloem vascular tissue |
| (3) Palisade cell | (9) Collenchyma |
| (4) Spongy cell | (10) Lower epidermis |
| (5) Stomata | (11) Parenchyma |
| (6) Xylem vascular tissue | |

4.2.2 Microscopic measurement

The microscopic leaf measurement of two *Eurycoma* species, three *Erythroxylum* species and two *Tinospora* species including stomatal number, stomatal index, palisade ratio, epidermal cell number and epidermal cell area were demonstrated.

4.2.2.1 Leaf measurement of two *Eurycoma* species

The results of leaf constant number of *Eurycoma longifolia* and *Eurycoma harmandiana* were shown in **Table 4.4**.

Table 4.4 Leaf constant number of *Eurycoma longifolia* and *Eurycoma harmandiana*

Leaf constant number Mean±SD (Min-Max)	<i>E. longifolia</i>	<i>E. harmandiana</i>
Type of stomata		
Upper epidermis	Absent	Absent
Lower epidermis	Anomocytic	Anomocytic
Stomatal number		
Upper epidermis	Absent	Absent
Lower epidermis	Uncountable	Uncountable
Epidermal cell number (lower epidermis)	Uncountable	Uncountable
Stomatal index		
Upper epidermis	Absent	Absent
Lower epidermis	Uncountable	Uncountable
Palisade ratio	5.08±0.62 (3.75-6.25)	Uncountable
Epidermal cell area (µm²) (upper epidermis)	1,521.13±40.89 (1,445.09-1,602.56)	Uncountable

4.2.2.2 Leaf measurement of three *Erythroxylum* species

The results of leaf constant number of *Erythroxylum novogranatense*, *Erythroxylum cambodianum* and *Erythroxylum cuneatum* were shown in **Table 4.5**.

Table 4.5 Leaf constant number of *Erythroxylum novogranatense*, *Erythroxylum cambodianum* and *Erythroxylum cuneatum*

Leaf constant number Mean±SD (Min-Max)	<i>E. novogranatense</i>	<i>E. cambodianum</i>	<i>E. cuneatum</i>
Type of stomata			
Upper epidermis	Absent	Absent	Absent
Lower epidermis	Paracytic	Paracytic	Paracytic
Stomatal number			
Upper epidermis	Absent	Absent	Absent
Lower epidermis	137.60±12.46 (112-164)	111.87±13.31 (84-144)	131.20±27.01 (80-172)
Epidermal cell number (lower epidermis)	1,285.33±77.79 (1,168-1,240)	600.00±36.59 (548-680)	613.07±58.83 (484-716)
Stomatal index			
Upper epidermis	Absent	Absent	Absent
Lower epidermis	9.69±0.93 (7.51-12.05)	15.70±1.43 (12.96-18.45)	17.55±1.73 (13.81-20.77)
Palisade ratio	8.91±0.52 (7.75-9.50)	9.88±1.14 (7.50-12.50)	7.95±0.47 (7.25-9.00)
Epidermal cell area (µm ²) (upper epidermis)	882.77±43.59 (803.80-965.25)	1325.10±47.81 (1243.78-1436.78)	975.63±42.31 (915.75-1082.25)

4.2.2.3 Leaf measurement of two *Tinospora* species

The results of leaf constant number of *Tinospora crispa* and *Tinospora baenzigeri* were shown in **Table 4.6**.

Table 4.6 Leaf constant number of *Tinospora crispa* and *Tinospora baenzigeri*

Leaf constant number Mean±SD (Min-Max)	<i>T. crispa</i>	<i>T. baenzigeri</i>
Type of stomata		
Upper epidermis	Absent	Anomocytic
Lower epidermis	Anomocytic	Anomocytic
Stomatal number		
Upper epidermis	Absent	16.93±6.27 (8-28)
Lower epidermis	190.40±21.65 (156-236)	84.66±9.80 (64-100)
Epidermal cell number		
(lower epidermis)	1,375.60±50.02 (1,264-1,468)	727.47±54.48 (624-816)
Stomatal index		
Upper epidermis	Absent	2.09±0.74 (0.9-3.48)
Lower epidermis	12.13±0.97 (10.60-13.85)	10.41±0.80 (8.55-12.06)
Palisade ratio		
	8.30±0.46 (7.50-9.00)	6.40±0.62 (5.25-7.50)
Epidermal cell area (µm²)		
(upper epidermis)	1,341.18±64.02 (1,256.28-1,497.00)	1,243.11±55.46 (1,116.07-1,351.35)

4.2.3 Type of stomata

4.2.2.1 Stomatal type of two *Eurycoma* species

Stomatal type of *Eurycoma longifolia* and *Eurycoma harmandiana* were anomocytic type and the leaf epidermal cells was shown in **Figure 4.15**.

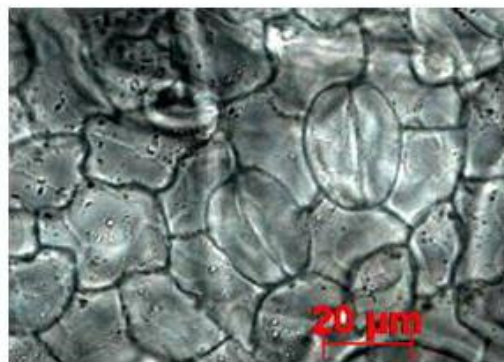

(a)

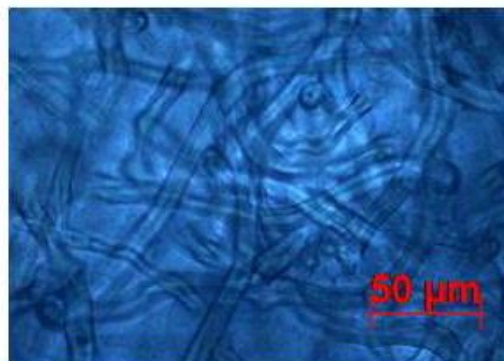

(b)

Figure 4.15 Photographs of stomatal cells of two *Eurycoma* species: Lower surface of *Eurycoma longifolia* (a) and lower surface of *Eurycoma harmandiana* (b).

4.2.2.2 Stomatal type of three *Erythroxylum* species

Stomatal type of *Erythroxylum novogranatense*, *Erythroxylum cambodianum* and *Erythroxylum cuneatum* were paracytic type and the leaf epidermal cells was shown in Figure 4.16.

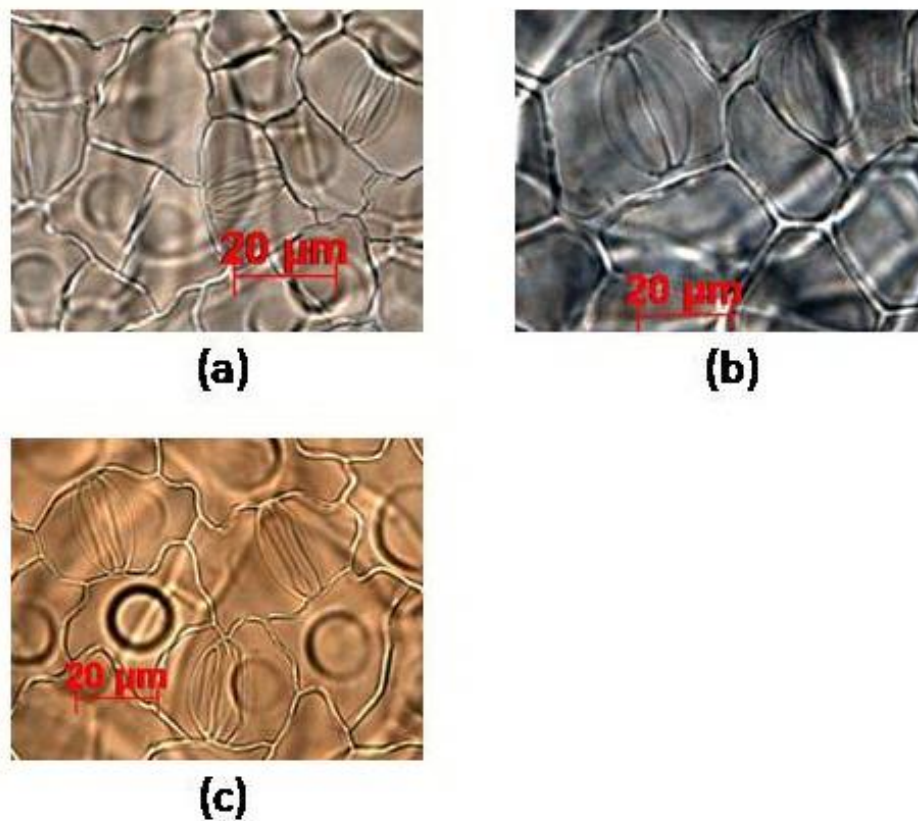

Figure 4.16 Photographs of stomata cells of three *Erythroxylum* species: lower surface of *Erythroxylum novogranatense* (a), lower surface of *Erythroxylum cambodianum* (b) lower surface stomata of *Erythroxylum cuneatum* (c).

4.2.2.3 Stomatal type of two *Tinospora* species

Stomatal type of *Tinospora crispa* and *Tinospora baenzigeri* were anomocytic type and the leaf epidermal cells was shown in **Figure 4.17**.

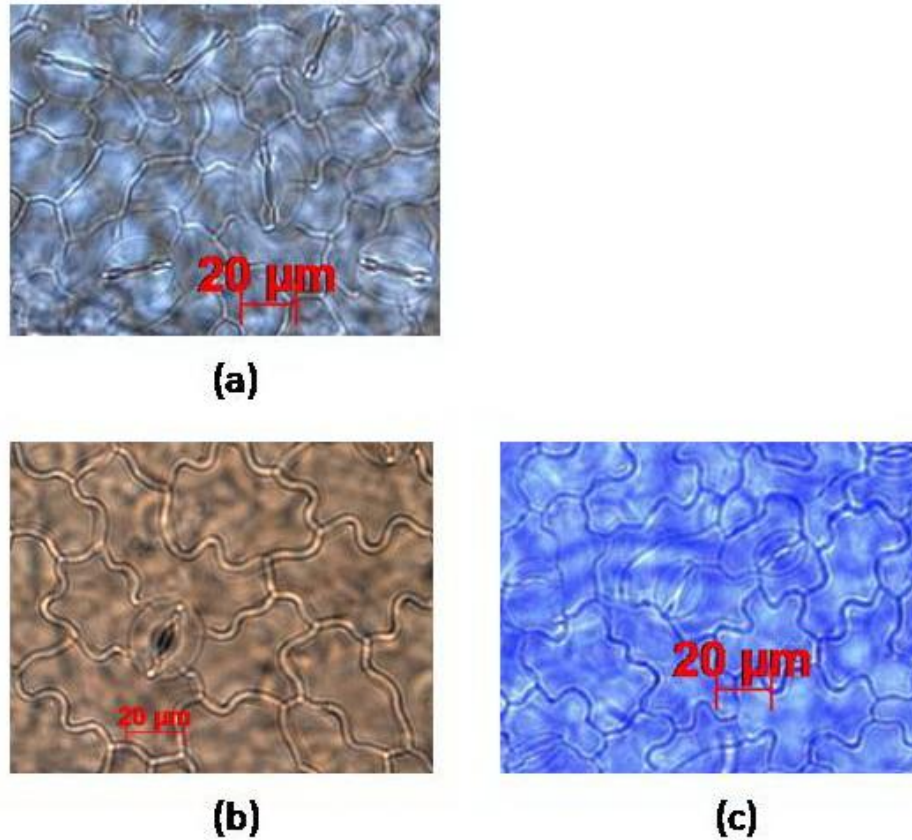

Figure 4.17 Photographs of stomatal cells of two *Tinospora* species: lower surface of *Tinospora crispa* (a), upper and lower surface of *Tinospora baenzigeri* (b,c).

4.3 Molecular evaluation

4.3.1 DNA extraction

Total genomic DNA of two *Eurycoma* species, three *Erythroxylum* species and two *Tinospora* species were extracted from young fresh leave using modified CTAB as described in chapter 3.

4.3.2 AFLP analysis

For AFLP analysis, a total of forty eight AFLP primer combinations were screened. Five primer combinations; E+ACG/M+CTT, E+ACG/M+CTG, E+ACG/M+CAA, E+ACG/M+CGC and E+ACC/M+CTA that could be accurately scored and highly polymorphic fragment were collected.

4.3.2.1 AFLP analysis of two *Eurycoma* species

The totals of 348 bands ranging in size from 70-800 base pairs were generated from 5 primer combinations (E+ACG/M+CTT, E+ACG/M+CTG, E+ACG/M+CAA, E+ACG/M+CGC and E+ACC/M+CTA), of which 335 bands were polymorphic (96.26%). The AFLP banding was ranging from 62 to 85 bands with an average of 69.60 bands by each primer combination. The highest number of AFLP bands (85 bands) was generated from E+ACG/M+CTT and the lowest (62 bands) from E+ACG/M+CGC primer combination (**Table 4.7**). The AFLP profile of *E. longifolia* and *E. harmandiana* obtained from E+ACG/M+CTT was showed in **Figure 4.18**.

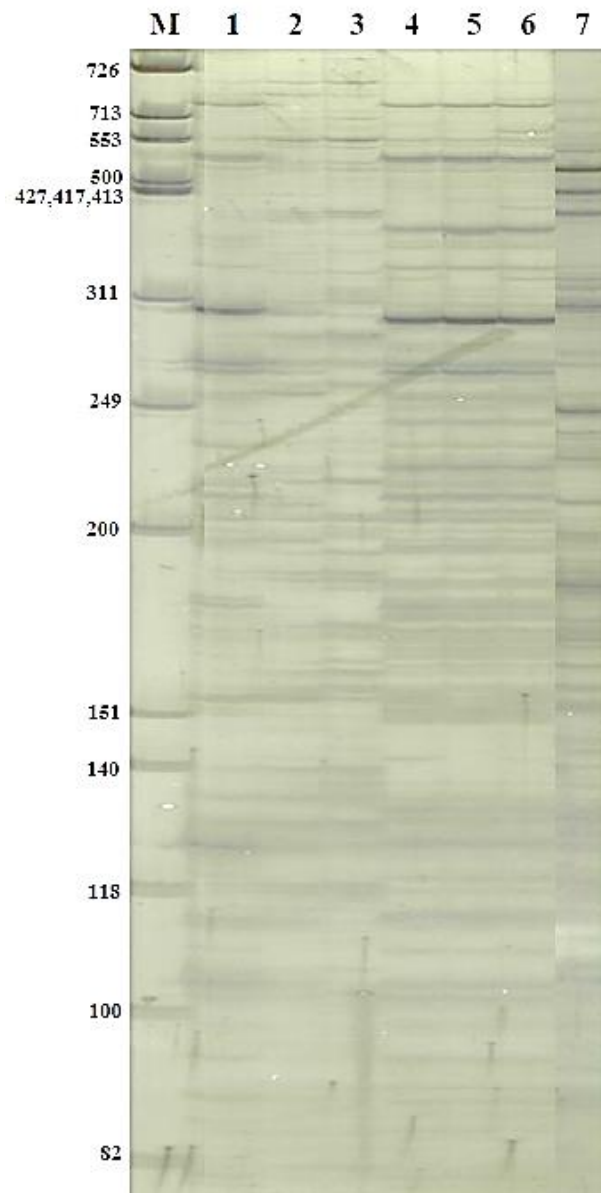

Figure 4.18 AFLP profile of 2 *Eurycoma* species in various locations and *Strychnos nux-vomica* (outgroup plant) obtained from E+ACG/M+CTT primer combinations

Lane M: phiX174 DNA/*Hinf*I Marker

Lane 4: *E. harmandiana* (Location 1; EHA-1)

Lane 1: *E. longifolia* (Location 1; ELO-1)

Lane 5: *E. harmandiana* (Location 2; EHA-2)

Lane 2: *E. longifolia* (Location 2; ELO-2)

Lane 6: *E. harmandiana* (Location 3; EHA-3)

Lane 3: *E. longifolia* (Location 3; ELO-3)

Lane 7: *Strychnos nux-vomica* (outgroup; SNV)

Table 4.7 Primer combination, number of AFLP bands, size range and percentage of polymorphic band of two *Eurycoma* species

Primer combination	No. of AFLP band	Size range (bp)	No. of polymorphic bands	Polymorphism (%)
E+ACG/M+CTT	85	70-750	83	97.65
E+ACG/M+CTG	65	70-750	63	96.92
E+ACG/M+CAA	69	70-750	66	95.65
E+ACG/M+CGC	62	70-750	60	96.77
E+ACC/M+CTA	67	70-750	63	94.03
Total	348	70-750	335	96.26

For the genetic relationship, the genetic diversity estimates (GDEs) were used for UPGMA clustering by calculated from the overall Jaccard's coefficient similarity matrix obtained from five primers combination based on AFLP analysis (**Table 4.8**).

Table 4.8 Jaccard's coefficient similarity index between *E. longifolia* and *E. harmandiana* based on AFLP markers

Species	(1) ELO-1	(2) ELO -2	(3) ELO-3	(4) EHA-1	(5) EHA-2	(6) EHA-3	(7) SNV
ELO-1 (1)	1.000						
ELO-2 (2)	0.676	1.000					
ELO-3 (3)	0.604	0.759	1.000				
EHA-1 (4)	0.381	0.380	0.331	1.000			
EHA-2 (5)	0.398	0.386	0.342	0.957	1.000		
EHA-3 (6)	0.409	0.407	0.358	0.880	0.886	1.000	
SNV (7)	0.205	0.227	0.195	0.201	0.209	0.200	1.000

ELO= *E. longifolia*, EHA= *E. harmandiana* and SNV= *Strychnos nux-vomica*

Jaccard's coefficient similarity index ranges from 0.331 to 0.957. According to the dendrogram, both *E. longifolia* and *E. harmandiana* collected from 3 different locations was clearly separated from each other. First groups (A) in the dendrogram are *E. harmandiana* whereas the second groups (B) are *E. longifolia*. *Strychnos nux-vomica* was used as outgroup plant and clearly separated from two *Eurycoma* species (Figure 4.19).

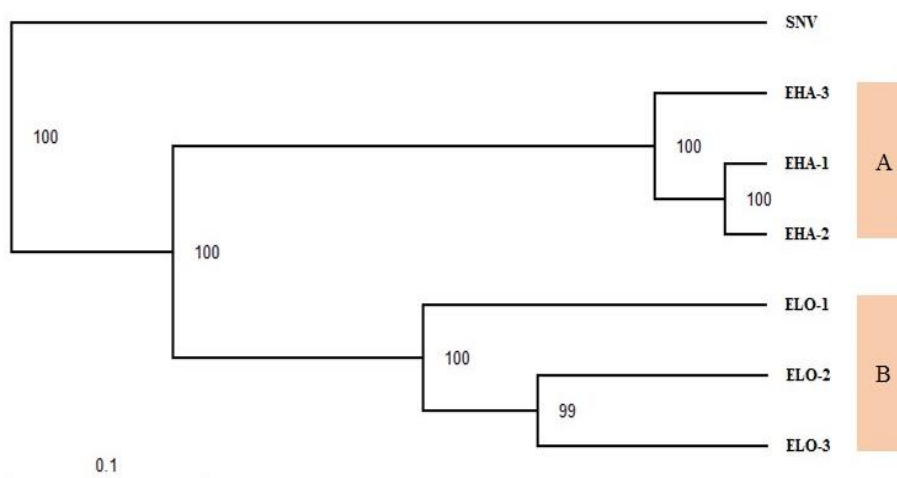

Figure 4.19 UPGMA dendrogram based on Jaccard's similarity coefficient of *Eurycoma* species and outgroup plant. The scale bar indicated the genetic distance of 0.1

4.3.2.2 AFLP analysis of three *Erythroxylum* species

The totals of 349 bands ranging in size from 50-750 base pairs were generated from these 5 primer combinations, of which 340 bands were polymorphic (97.42%). The AFLP banding was ranging from 58 to 91 bands with an average of 69.80 bands by each primer combination. The highest number of AFLP bands (91 bands) was generated from E+ACG/M+CTT and the lowest (58 bands) from E+ACG/M+CGC primer combination (Table 4.9). The AFLP profile of *E. novogranatense*, *E. cambodianum* and *E. cuneatum* obtained from E+ACG/M+CTT was showed in Figure 4.20.

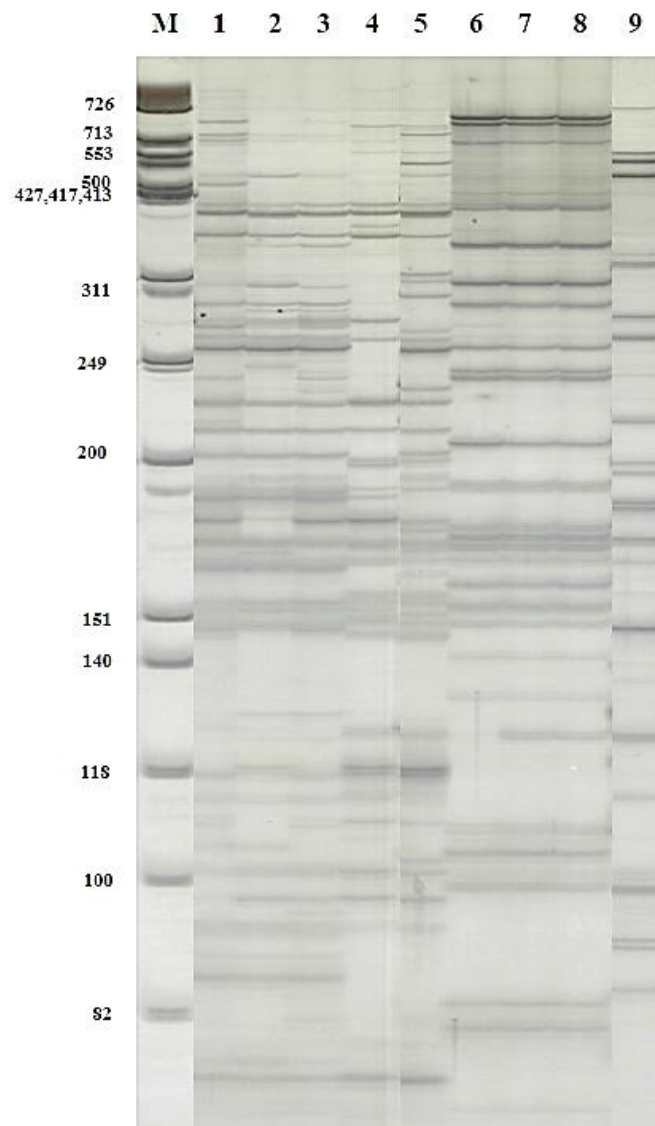

Figure 4.20 AFLP profile of 3 *Erythroxylum* species in various locations and *Strychnos nux-vomica* (outgroup plant) obtained from E+ACG/M+CTT primer combinations.

Lane M: phiX174 DNA/*HinfI* Marker

Lane 1: *E. cambodianum* (Location 1; ECA-1)

Lane 6: *E. novogranatense* (Location 1; ENO-1)

Lane 2: *E. cambodianum* (Location 2; ECA-2)

Lane 7: *E. novogranatense* (Location 2; ENO-2)

Lane 3: *E. cambodianum* (Location 3; ECA-3)

Lane 8: *E. novogranatense* (Location 3; ENO-3)

Lane 4: *E. cuneatum* (Location 1; ECU-1)

Lane 9: *Strychnos nux-vomica* (outgroup; SNV)

Lane 5: *E. cuneatum* (Location 2; ECU-2)

Table 4.9 Primer combination, number of AFLP bands, size range and percentage of polymorphic band in three *Erythroxylum* species

Primer combination	No. of AFLP band	Size range (bp)	No. of polymorphic bands	Polymorphism (%)
E+ACG/M+CTT	91	50-750	90	98.90
E+ACG/M+CTG	64	50-750	62	96.88
E+ACG/M+CAA	63	50-750	59	93.65
E+ACG/M+CGC	58	50-750	58	100.00
E+ACC/M+CTA	73	50-750	71	97.26
Total	349	50-750	340	97.42

For the genetic relationship, the genetic diversity estimates (GDEs) were used for UPGMA clustering by calculated from the overall Jaccard's coefficient similarity matrix obtained from five primers combination based on AFLP analysis (**Table 4.10**).

Table 4.10 Jaccard's coefficient similarity index between *E. cambodianum*, *E. cuneatum* and *E. novogranatense* based on AFLP markers

Species	(1) ECA-1	(2) ELO -2	(3) ECA-3	(4) ECU-1	(5) ECU-2	(6) ENO-1	(7) ENO-2	(8) ENO-3	(9) SNV
ECA-1 (1)	1.000								
ECA-2 (2)	0.715	1.000							
ECA-3 (3)	0.692	0.859	1.000						
ECU-1 (4)	0.419	0.439	0.426	1.000					
ECU-2 (5)	0.416	0.443	0.424	0.850	1.000				
ENO-1 (6)	0.316	0.301	0.295	0.270	0.272	1.000			
ENO-2 (7)	0.311	0.291	0.284	0.275	0.287	0.923	1.000		
ENO-3 (8)	0.311	0.291	0.279	0.270	0.282	0.923	0.988	1.000	
SNV (9)	0.168	0.173	0.182	0.178	0.190	0.176	0.185	0.179	1.000

ECA = *cambodianum*, ECU = *E. cuneatum*, ENO = *E. novogranatense* and SNV=*Strychnos nux-vomica*

Jaccard's coefficient similarity index ranges from 0.270 to 0.988. According to the dendrogram, plant samples in *Erythroxylum* genus; *E. cambodianum*, *E. cuneatum* and *E. novogranatense* collected from 3 different locations was clearly separated from each other. First groups (A) in the dendrogram are *E. cambodianum* whereas the second groups (B) are *E. cuneatum*. Third groups (C) are *E. novogranatense*. *Strychnos nux-vomica* was used as outgroup plant and clearly separated from three *Erythroxylum* species (Figure 4.21).

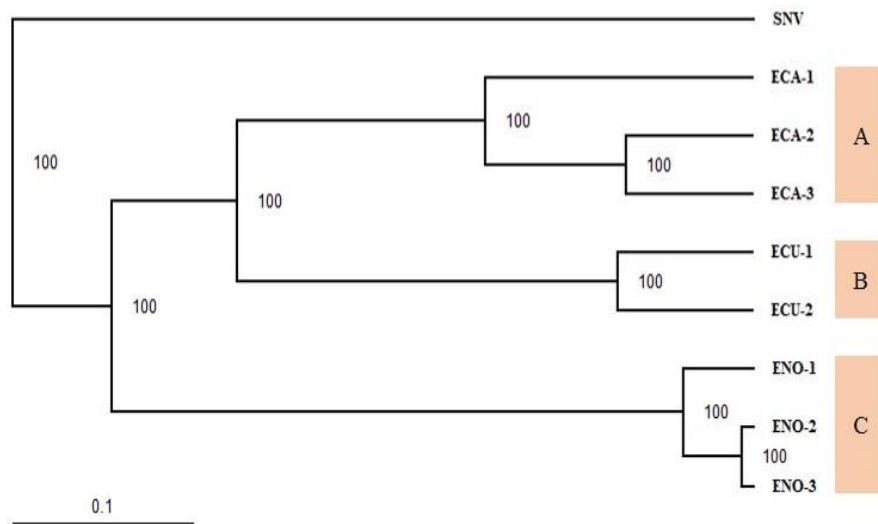

Figure 4.21 UPGMA dendrogram based on Jaccard's similarity coefficient of *Erythroxylum* species and outgroup plant. The scale bar indicated the genetic distance of 0.1

4.3.2.3 AFLP analysis of two *Tinospora* species

The totals of 476 bands ranging in size from 50-800 base pairs were generated from 5 primer combinations, of which 457 bands were polymorphic (96%). The AFLP banding was ranging from 75 to 125 bands with an average of 95.2 bands by each primer combination. The highest number of AFLP bands (125 bands) was generated from E+ACG/M+CTT and the lowest (75 bands) from E+ACG/M+CAA primer combination (Table 4.11). The AFLP profile of *T. crispa* and *T. baenzigeri* obtained from E+ACG/M+CTT was showed in Figure 4.22.

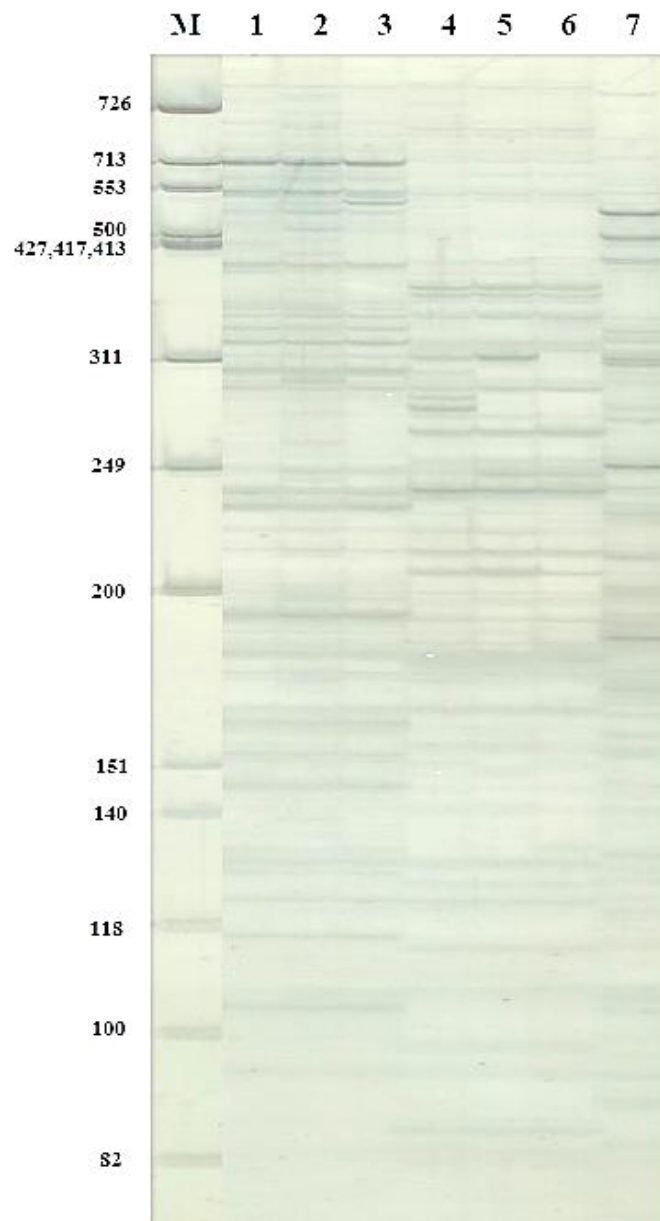

Figure 4.22 AFLP profile of 2 *Tinospora* species in various locations *Strychnos nux-vomica* (outgroup plant) obtained from E+ACG/M+CTT primer combinations.

Lane M: phiX174 DNA/*Hinf*I Marker

Lane 1: *T. crisper* (Location 1; TCR-1)

Lane 2: *T. crisper* (Location 2; TCR-2)

Lane 3: *T. crisper* (Location 3; TCR-3)

Lane 4: *T. baenzigeri* (Location 1; TBA-1)

Lane 5: *T. baenzigeri* (Location 2; TBA-2)

Lane 6: *T. baenzigeri* (Location 3; TBA-3)

Lane 7: *Strychnos nux-vomica* (outgroup; SNV)

Table 4.11 Primer combination, number of AFLP bands, size range and percentage of polymorphic band in two *Tinospora* species

Primer combination	No. of AFLP band	Size range (bp)	No. of polymorphic bands	Polymorphism (%)
E+ACG/M+CTT	125	50-800	123	98.40
E+ACG/M+CTG	82	50-800	79	96.34
E+ACG/M+CAA	75	50-800	68	90.67
E+ACG/M+CGC	87	50-800	85	97.70
E+ACC/M+CTA	107	50-800	102	95.33
Total	476	50-800	457	96.01

For the genetic relationship, the genetic diversity estimates (GDEs) were used for UPGMA clustering by calculated from the overall Jaccard's coefficient similarity matrix obtained from five primers combination based on AFLP analysis (**Table 4.12**).

Table 4.12 Jaccard's coefficient similarity index between *T. crispa* and *T. baenzigeri* based on AFLP markers

Species	(1) TCR-1	(2) TCR-2	(3) TCR-3	(4) TBA-1	(5) TBA-2	(6) TBA-3	(7) SNV
TCR-1 (1)	1.000						
TCR-2 (2)	0.816	1.000					
TCR-3 (3)	0.915	0.820	1.000				
TBA-1 (4)	0.484	0.472	0.480	1.000			
TBA-2 (5)	0.481	0.476	0.483	0.925	1.000		
TBA-3 (6)	0.486	0.485	0.488	0.920	0.934	1.000	
SNV (7)	0.143	0.159	0.144	0.160	0.159	0.158	1.000

TCR= *T. crispa*, TBA= *T. baenzigeri* and SNV= *Strychnos nux-vomica*

Jaccard's coefficient similarity index ranges from 0.472 to 0.934. According to the dendrogram, both *T. crispera* and *T. baenzieri* collected from 3 different locations was clearly separated from each other. First groups (A) in the dendrogram are *T. baenzieri* whereas the second groups (B) are *T. crispera*. *Strychnos nux-vomica* was used as outgroup plant and clearly separated from two *Tinospora* species (Figure 4.23).

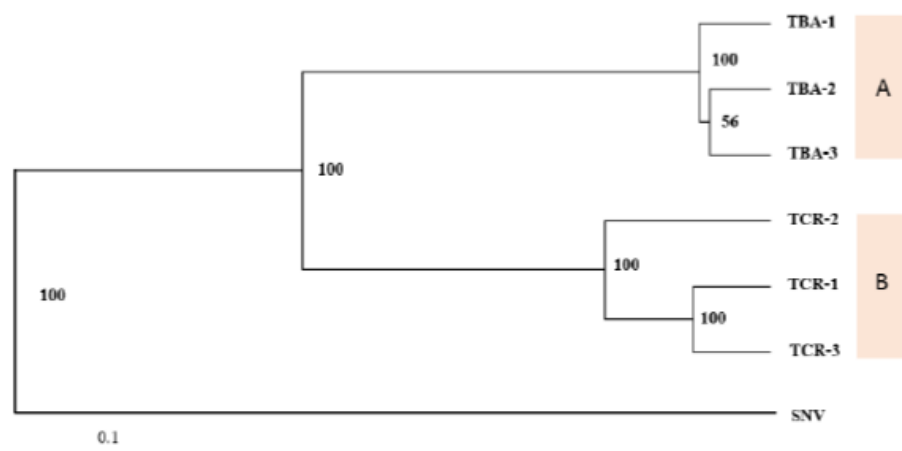

Figure 4.23 UPGMA dendrogram based on Jaccard's similarity coefficient of *Tinospora* species and outgroup plant. The scale bar indicated the genetic distance of 0.1

4.4 Standardization of *Eurycoma longifolia* Jack root

Eurycoma longifolia root crude drug was examined by macroscopic examination, microscopic examination and TLC fingerprint according to World Health Organization (WHO) guideline standard methods.

4.4.1 Macroscopic examination

Scientific Name: *Eurycoma longifolia* Jack

Common Name: Pla Lai Phueak (ปลาไหลเผือก)

Local Name: Krung Badan (Surat Thani), Lai Phueak (Trang), Cha nang (Trat), Trueng Badan (Pattani), Tu-wu-bo-ming (Narathiwat), Hae Phan Chan (Northern), Yik Bo Thong (Northeastern)

Other Names: Tongkat Ali or Malaysia ginseng (Malaysia), Pasak Bumi or Bedara Pahit (Indonesia), Cay Ba Benh (Vietnam), Tho Nan (Laotian), Lan-Don (Thailand)

Family: Simaroubaceae

Distribution: Indigenous to South-East Asian countries like Malaysia, Indonesia, and Vietnam, some of the plant species are also found in certain patches in regions of Cambodia, Myanmar, Laos and in Thailand

Description: *E. longifolia* is a medium-sized slender shrub, which grows in sandy soil. Tree is tall which can growing to 15 m with spirally arranged, pinnate leaves, The numerous leaflets are opposite or subopposite, lanceolate to ovate-lanceolate, 20-40 cm long, each compound leaf consists of 13-41 leaflets, 1.5-6 cm wide and green colour with smooth margins. The flowers are dioecious, tiny, reddish, unisexual and are densely arranged, each flower with 5-6 very small petals. Inflorescence axillary, in large brownish red panicle, very pubescent with very fine, soft, glandular trichomes. The flower are densely arranged and they turn dark reddish brown when ripe. The drupes are ovoid, 1-2 cm long and 0.5-1 cm broad, yellowish brown when young and brownish red when ripe. The morphological characteristics of *E. longifolia*

was showed in **Figure 4.24**. A shade-dried root was a white-yellow to pale brown color and the taste was bitter (**figure 4.25**).



Figure 4.24 Photography of *Eurycoma longifolia* Jack; (A) habitat, (B) leaves, (C) ripe fruits, (D) young fruits, (E) inflorescences, (F) ripe flowers, and (G) young flowers



Figure 4.25 Photograph of crude drug of *E. longifolia* root

4.4.2 Microscopic examination

The anatomical character (transverse section of *E. longifolia* root) and histological character (powdered samples of *E. longifolia* root) were evaluated and shown in **Figure 4.26** and **Figure 4.27**.

4.4.2.1 Anatomical character

The anatomical characters of *E. longifolia* root demonstrated the epidermis, epiderm, cortex, phloem, xylem, xylem vessel, xylem ray with starch granules, xylem fiber and pith (**Figure 4.26**).

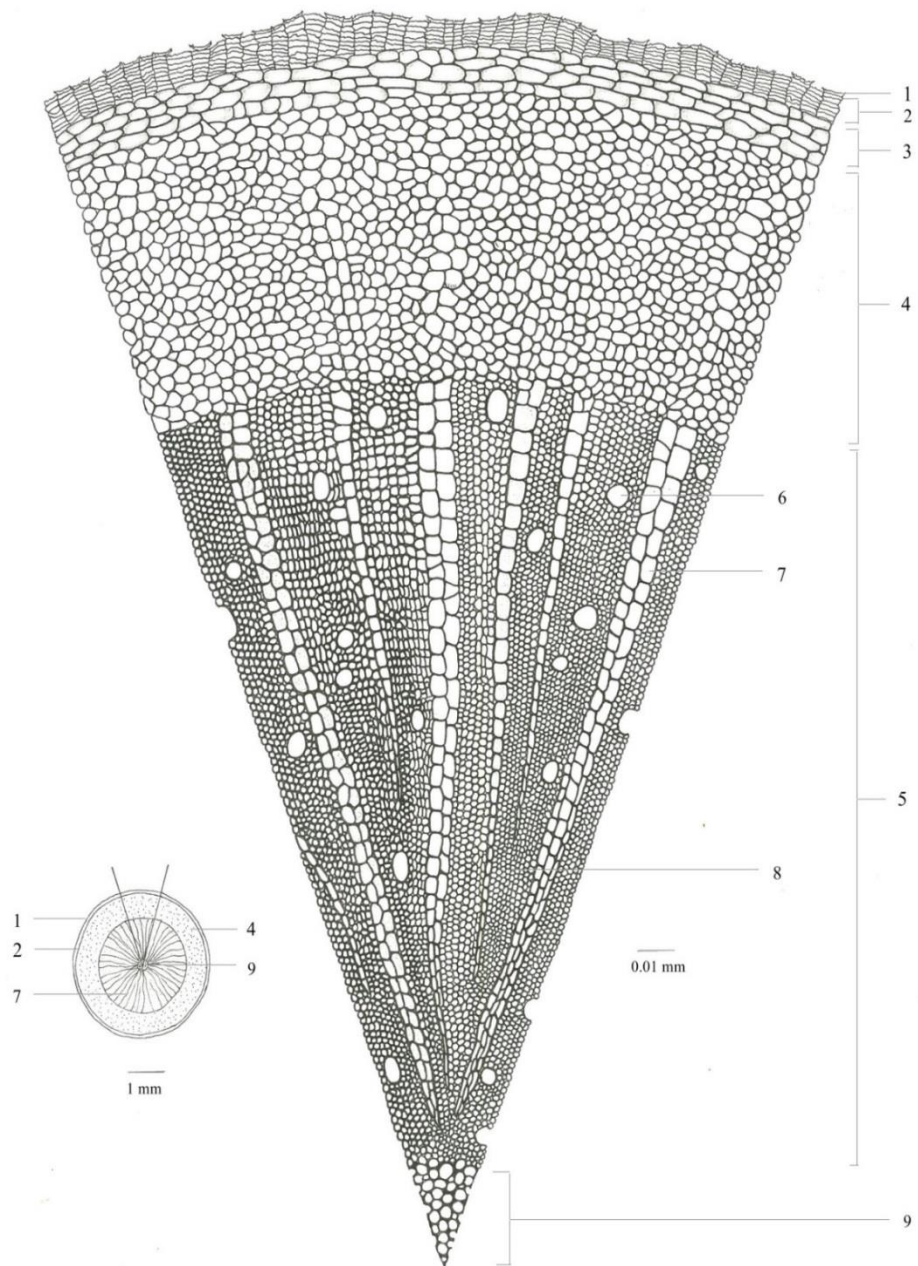

Figure 4.26 Transverse section of *E. longifolia* root: epidermis (1), epiderm (2), cortex (3), phloem (4), xylem (5), xylem vessel (6), xylem ray with starch granules (7), xylem fiber (8) and pith (9).

4.4.2.2 Histological character

The histological characters of *E. longifolia* root powder demonstrated the sclereid, bordered pitted vessel, fiber, cork, parenchyma containing crystal of calcium oxalate, parenchyma containing starch grain, brownish mass, starch grain, parenchyma, fragment of medullary ray (Figure 4.27).

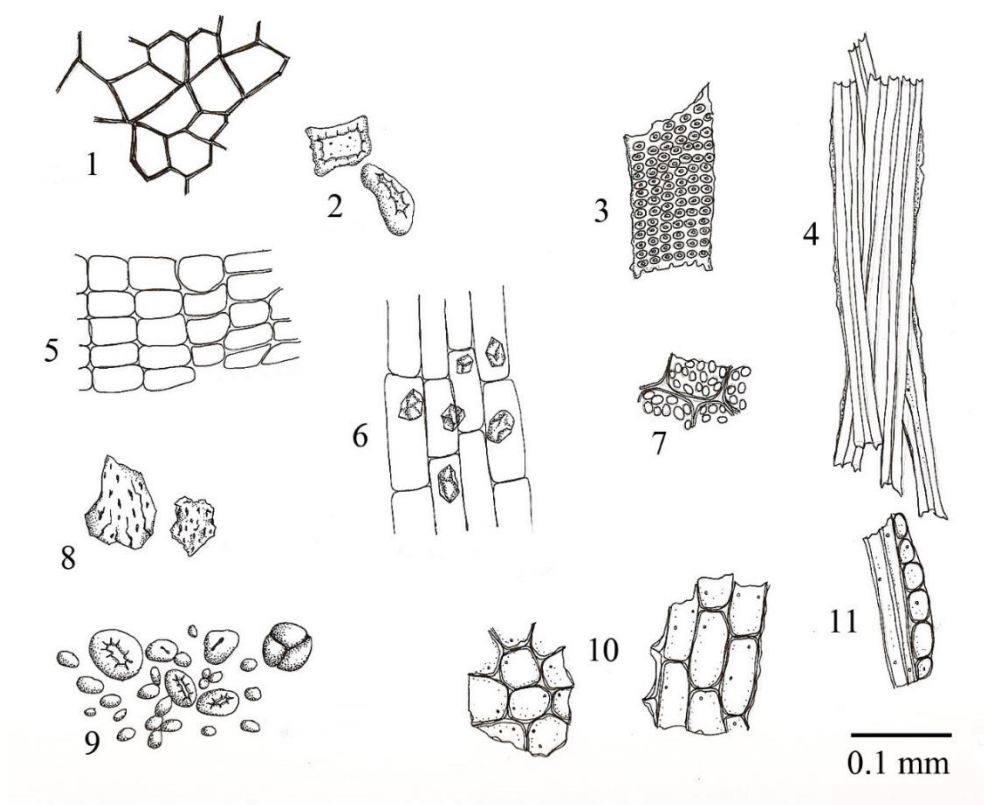

Figure 4.27 Powdered of *E. longifolia* root: cork in surface view (1); sclereid (2); fragment of bordered pitted vessel (3); fragment of fiber (4); cork in sectional view (5); parenchyma containing crystal of calcium oxalate (6); parenchyma containing starch grain (7); brownish mass (8); starch grain (9); fragment of parenchyma (10); fragment of medullary ray (11).

4.4.3 Physicochemical parameters

The physicochemical analysis of *E. longifolia* root powder including total ash, acid insoluble ash, loss on drying, water soluble extractives, ethanol soluble extractives and water content were determined and the results were shown in **Table 4.13**.

Table 4.13 Physicochemical parameters analysis of *E. longifolia* root

Content (% by weight)	Mean	SD	Range (Mean±SD)
Total ash	1.973	0.039	1.857-2.088
Acid insoluble ash	0.696	0.064	0.503-0.889
Loss on drying	7.515	0.252	6.760-8.271
Water soluble extractives	4.888	0.376	3.760-6.017
Ethanol soluble extractives	1.733	0.178	1.199-2.267
Water content	13.352	0.839	10.836-15.869

*Results were expressed as grand mean ± pooled SD from 15 samples in triplicate

4.4.4 TLC fingerprint

TLC analysis of the root of *E. longifolia* using chloroform : methanol (9:1) as mobile phase revealed the presence of certain prominent spots (Figure 4.28). The TLC fingerprint of *E. longifolia* root showed characteristic profiles that could be used as markers for quality evaluation and standardization of this plant species.

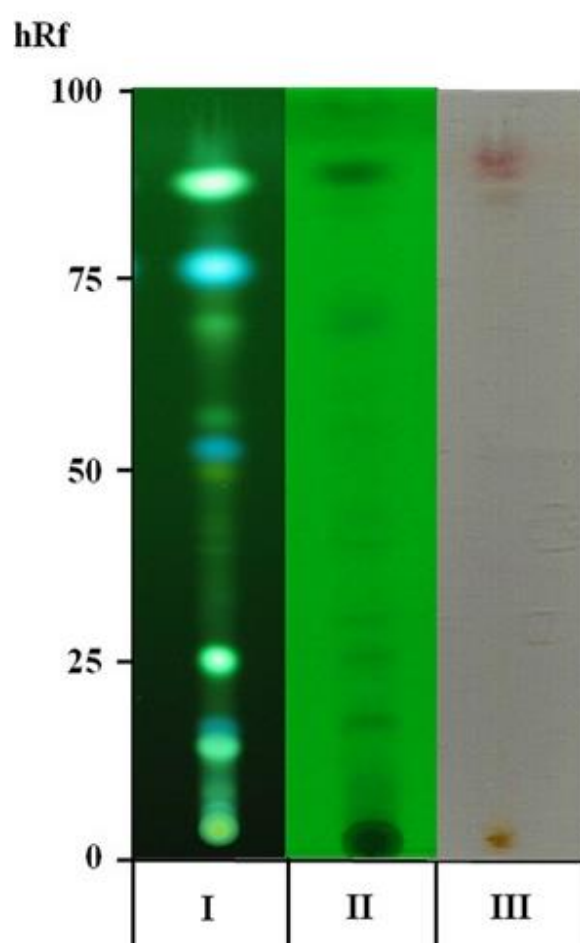

Figure 4.28 TLC fingerprint of *E. longifolia* root: under UV light 366 nm (I); under UV light 254 nm (II); under daylight after spray with p-anisaldehyde reagent (III)

CHAPTER V

DISCUSSION AND CONCLUSION

Herbal medicine refers to the use of plants and herbs for the purpose of cure and primary healthcare of human ailments. The use of herbals have been interested in the complementary and alternative medicine as they are safer than modern medicines and has been established by various phytochemical and pharmacological studies [63]. Some herbal plants in genera *Eurycoma*, *Erythroxylum* and *Tinospora* have been widely used to relieve the symptom of fever and health supplement [20, 21]. However, correct identification is very important for protection of the misidentification usage of medicinal plants. Therefore, the authentication and standardization of medicinal plants are required for the quality control, as adulteration or substitution has become an essential for reliable identification to ensure the quality, safety and efficacy of their medicinal properties [5]. Presently, various of the authentic analytical methods such as macroscopic and microscopic identification, chemical profiling, biological tests and molecular technique were useful methods for quality assessment in many herbal plants [62]. Due to the similarity of morphological characteristics, this study proposed the macroscopic/microscopic identification and molecular authentication of selected genus *Eurycoma* (*E. longifolia* Jack and *E. harmandiana*), genus *Erythroxylum* (*E. novogranatense*, *E. cambodianum* and *E. cuneatum*), genus *Tinospora* (*T. crispa* and *T. baenzigeri*). The pharmacognostic specification of *E. longifolia* root was established as well.

Anatomical and histological studies of leaf can be used for discrimination of differential internal structures of difference species. Midrib transverse section is the one of a new tool to identify plant species and assist plant classification. Microscopic examination as anatomical characters was evaluated by transverse section of leaf showed bifacial structure. Two *Eurycoma* species demonstrated the difference of multicellular trichome between two species. Three *Erythroxylum* species demonstrated obviously distinguished arrangement of vessel members. These internal characteristics can be used for classification of three *Erythroxylum* species. Two *Tinospora* species showed the similar arrangement of cell components, but differs in

shape and arrangement of parenchyma cell between two species. According to the results, microscopic evaluation of these plants revealed the different botanical morphology but contained almost similar cell components. The arrangement of vessel members are also one of the important characteristics that can be used for identification of these three genera which are normally similar between individuals of the same genus. Therefore, each cell types, size, form, arrangement and distribution of cell components by midrib transverse section can provide distinguished identity for these plants.

The one of microscopic evaluation which can distinguish plant species is stomatal type by their form and arrangement in the surrounding cells [62]. In this study, the stomata type of two *Eurycoma* species and two *Tinospora* species were classified as anomocytic type or ranunculaceous type of stomata which irregular cell type (stomata is surrounded by varying number of cells, which are generally not different from those of the epidermis) which supported in characteristics of genus *Eurycoma* in Simaroubaceae family [64] and genus *Tinospora* in Menispermaceae family [65]. Three *Erythroxylum* species were classified as paracytic type or rubiaceous type of stomata which parallel cell type (stomata has two subsidiary cells, of which the long axes are parallel to the axis of the stomata) and supported with botanical characteristics of genus *Erythroxylum* in Erythroxylaceae family [41]. The stomata were found on both adaxial (upper epidermis) and abaxial (lower epidermis) which called amphistomatic leaf as distribution of stomata. The characteristic of stomata was only existed on the abaxial of two *Eurycoma* species, three *Erythroxylum* species and *T. crispa* (hypostomatic leaf; stomata presenting only on lower epidermis). While stomata was occurred on both sides of adaxial and abaxial in *T. baenzigeri*. (amphistomatic leaf; stomata presenting on both upper and lower epidermis) which is an important characteristic that can be used to distinguish between two *Tinospora* species.

In this study, determination of microscopic leaf constant numbers were considered as one of useful parameters which could be distinguish of plant species. For leaf constant values, fresh mature leaves were examined under microscope and evaluated including stomata number, stomata index, palisade ratio, epidermal cell number and epidermal cell area. The constant values of each species in the same

genus were shown individual values. In recent study, the constant numbers of *E. harmandiana* and some constant numbers of *E. longifolia* could not measure by counting the constant values because this genus was shown more spongy cell was interfered the epidermal cell and stomata cell. According to the results, determination of leaf constant numbers was considered as one of an important tools and useful parameter for the identification of these herbal plant. As the constant values of these species have never been previously reported, this recent study is the first report of these species. In previous research, leaf constant values have been widely used for Thai medicinal plants identification [66-68]. However, morphological identification is often not possible when the original plant materials has been processed. Therefore, additional methods of identification at the species level have been sought and genome-based methods have been developed for herbal authentication.

Based on the molecular technique, DNA fingerprints could be utilized for addressing the problem of quality control of herbal medicines. Many methods of DNA fingerprinting were used for molecular makers as previous research such as using microsatellite markers and AFLP of Hashemi aromatic rice [69], PCR-RFLP technique to distinguish three *Phyllanthus* spp. [70], ISSR and RAPD techniques in *Acorus calamus* L. [71] and AFLP and ISSR markers in *Merope angulate* [72]. However, these plants in this study were also carried out for assessing the molecular authentication. The AFLP technique due to generation of large number of polymorphic fragments used to investigate the genetic relationship of plant species [73]. In current study, a total of forty eight AFLP primers combination were screened and five primer combinations produced accurately scored and highly polymorphic fragments ranging size from 50-800 bps were collected. The high percentage of polymorphism indicates that there is a high level of genetic diversity among two *Eurycoma* species, three *Erythroxylum* species and two *Tinospora* species (96.26%, 97.42% and 96.01%) respectively. For genetic relationship, the genetic diversity estimates (GDEs) were used for UPGMA clustering by calculated from the overall Jaccard's similarity matrix. The dendrogram showed that each species in three genera (*Eurycoma*, *Erythroxylum* and *Tinospora*) can be clustered into each groups from each species in various locations from their differentiated morphological characteristics and leaf constant numbers. The outgroup

plant (*Strychnos nux-vomica*) was clearly separated from other species in each genera. Bootstrap analysis showed higher than 90% revealed that the branching in phylogenetic tree was stable, accuracy and robust of almost any statistical estimation. The results of genetic diversity of genus *Erythroxylum* in this study were supported by the results of identification of *Erythroxylum* taxa by AFLP analysis that are phenotypically similar, but genotype is distinguishable for identification [60]. The genetic information about molecular markers of genera *Eurycoma* and *Tinospora* in Thailand is still limited, but taxonomic data and pharmacognostic studies were shown in some previous research [74, 75]. Additionally, in this study showed correlation the molecular and morphological data. The genetic relationships through AFLP markers were also correlated with the morphological and microscopic characteristics when considering their constant values of *E. cambodianum* and *E. cuneatum* were different from *E. novogranatense* that correlated with the Jaccard's similarity coefficient based on genetic distance. The stomatal index of *E. cambodianum* and *E. cuneatum* are higher than *E. novogranatense*. The arrangement of phloem fiber of *E. cambodianum* and *E. cuneatum* are around the center of midrib but in *E. novogranatense* not shown as this character. The result of molecular markers could be useful for authentication of species level and can used for further taxonomy and pharmacological studies of these genera. This analytical method was very effective in detecting genetic variation in medicinal plants as well as *Tinospora* and revealed a large number of polymorphic bands (96%) and the similarity index (SI) ranges from 0.472 to 0.934 which similar to the result previously reported in the genetic diversity of *T. cordifolia* revealed the similarity indices ranged from 0.68-1.0 for ISSR and 0.52-0.96 for EST-SSR [76].

Therefore, AFLP markers is a powerful approaches to detect DNA polymorphism of species level in medicinal plants. Moreover, this method applicable to all organisms without previous sequence information and highly informative fingerprints [77]. This technique is most effective and efficient when compared to other marker technologies including microsatellites, RAPD and PCR-RFLP due to their high reproducibility, high resolution, and high sensitivity at the whole genome level [73]. AFLP fingerprint have been successfully when used for discrimination between closely related species and authentication of some other medicinal plants such as *Capparis*

species [78], *Boesenbergia* species [59] and *Zingiber* species [79]. DNA-based methods are more reliable which have been also introduced for species level authentication by comparing their genetic diversities, because the genetic information is unique for each individual species and not affected by physiological conditions and environmental factors. However, another DNA-based method such as sequence characterized amplified region (SCAR) marker and DNA barcoding or DNA sequencing should be further developed for more information and developing the genetic marker for species identification of their substitution and adulterants materials for identification of these species.

Establishing pharmacognostic specification is an important part of quality control according to World Health Organization (WHO) guideline standard methods. Standardization of dried root of *Eurycoma longifolia* Jack was carried out in the present study. The physicochemical parameters of 15 *E. longifolia* Jack were evaluated as determination of pharmacognostic parameters. Excessive water content and temperature are important factors affecting fungal and bacterial growth which cause spoilage. The water content value was 13.352 ± 0.839 , the less value of water content could prevent the medicinal plant from microorganism growth. The ash content used to find out quality and purity of medicinal plant by controlling the adulterant of foreign inorganic matter. The total ash and acid insoluble ash value were 1.973 ± 0.039 and 0.696 ± 0.064 respectively. The extractive value of *E. longifolia* Jack by water extraction is higher (4.888 ± 0.376) compared to ethanolic extraction (1.733 ± 0.178). The extractive values estimate the content of the chemical constituents in plant materials specified by the particular solvents. These values can determined the quality as well as purity of drug materials. TLC fingerprint showed the profiles that could be used as a markers for quality and standardization of crude drug. Physiochemical parameters can also serve as valuable data in evaluation of purity and quality of plant materials. Further study may be evaluate the safety test for measure a heavy metals, microbial limits and specific pathogens.

In conclusion, the results obtained from recent study can provide useful information and have successfully used for identification and distinguish of these two *Eurycoma* species, three *Erythroxylum* species and two *Tinospora* species. Testing

authentication by macroscopic evaluation, microscopic evaluation and AFLP fingerprinting provides useful information for correct identification. The results of this study can serve as a valuable source of important data and will play a significant role in setting of suitable standards for identification of medicinal plant in future study and applications for selecting correct herbal specimens. In addition, the results of this study may be useful in preparation of herbal medicine for these plant species. Although morphological characteristics, microscopic investigation and DNA fingerprinting can be useful for identification of plant species. The combination of various analytical methods in further investigation such as biological tests and chemical composition should be applied for more effectiveness identification and provide supporting evidence for the quality control of medicinal plants.



REFERENCES

1. Falzon, C.C. and A. Balabanova, *Phytotherapy: An Introduction to Herbal Medicine*. Primary Care: Clinics in Office Practice, 2017. **44**(2): p. 217-227.
2. Luangpirom, N., *Thai traditional medicine development: The proposed development model of modern Thai traditional medicine*. Asian Journal of Pharmaceutical Sciences, 2016. **11**(1): p. 87-88.
3. Organization, W.H., *Guidelines for the appropriate use of herbal medicines.*, ed. 88. 1998.
4. E.N., R., K.P. Namdeo, and P.K. Samal, *Standardization strategies for herbal drugs-an overview*. Research Journal of Pharmacy, 2008. **1**(4): p. 310-312.
5. Mukherjee, P., *Quality control of herbal drugs: an approach to evaluation of botanicals*, ed. n. ed. 2008, New Delhi: Business horizons publisher.
6. Evans WC, Trease, and Evans, *Pharmacognosy*, ed. t. ed. 2009: WB Saunders Elsevier Science Ltd.
7. Kanlayavattanakul M, et al., *Pharmacognostic specification of Naringi crenulata stem wood*. Journal of Health Research, 2009. **23**(2): p. 65-69.
8. Manohan, R., C. Palanuvej, and N. Ruangrunsi, *Pharmacognostic specifications of five root species in Ben-Cha-Moon-Yai remedy: Thai traditional medicine remedy*. Pharmacognosy Journal, 2013. **5**(2): p. 46-55.
9. Roonyamarai W, et al., *Microscopic and molecular analyses of selected Morinda species in Thailand*. . Asian J Tradit Med, 2011. **6**(3): p. 118-126.
10. Venkatesh S, et al., *Pharmacognostical studies on Dodonaea viscosa leaves*. Journal of Pharmacy Practice., 2008. **2**(4): p. 84-88.
11. Ibrahim, J.A., O. Makinde, and N.N. Ibekwe, *Pharmacognostic, Physicochemical Standardization and Phytochemical Analysis of leaves of Cultivated Crotalaria lachnosema Stapf*. Journal of Applied Pharmaceutical Science, 2012. **2**(9): p. 67-70.
12. Kuo, P.-C., et al., *Cytotoxic and antimalarial constituents from the roots of Eurycoma longifolia*. Bioorganic & Medicinal Chemistry, 2004. **12**(3): p. 537-544.

13. Chan, K.-L., et al., *Antiplasmodial studies of Eurycoma longifolia Jack using the lactate dehydrogenase assay of Plasmodium falciparum*. Journal of Ethnopharmacology, 2004. **92**(2-3): p. 223-227.
14. Kanchanapoom, T., et al., *Canthin-6-one and β -carboline alkaloids from Eurycoma harmandiana*. Phytochemistry, 2001. **56**(4): p. 383-386.
15. Ahmad, W., I. Jantan, and B.N. A., *Tinospora crispa (L.) Hook. f. & Thomson: A Review of Its Ethnobotanical, Phytochemical, and Pharmacological Aspects*. Frontiers in Pharmacology, 2016. **7**(59): p. 1-19.
16. Joshi K, et al., *Molecular markers in herbal drug technology*. Frontier in Pharmacology, 2004. **87**(2): p. 65-159.
17. Anand Patwardhan, Samit Raya, and A. Roy, *Molecular Markers in Phylogenetic Studies-A Review*. Journal of Phylogenetics & Evolutionary Biology, 2014. **2**(2): p. 1-9.
18. Kurt W, et al., *DNA Fingerprinting in plants: Principles, methods and application*, ed. t. ed. 2005: CRC Press.
19. Pourmohammad, A., *Application of molecular markers in medicinal plant studies*. Agriculture and Environment, 2013. **5**: p. 80-90.
20. SU, R., C. K, and Y. HH, *Review on a Traditional Herbal Medicine, Eurycoma longifolia Jack (Tongkat Ali): Its Traditional Uses, Chemistry, Evidence-Based Pharmacology and Toxicology*. Molecules, 2016. **21**(3): p. 1-31.
21. Bhat, R. and A.A. Karim, *Tongkat Ali (Eurycoma longifolia Jack): A review on its ethnobotany and pharmacological importance*. Fitoterapia, 2010. **81**(7): p. 669-679.
22. Miyake, K., et al., *Quassinoids from Eurycoma longifolia*. Journal of Natural Products, 2009. **72**(12): p. 2135-214.
23. Mahfudh, N. *Eurycomanone exert antiproliferative activity via apoptosis in hela cells*. in *International Conference on Mathematics and Natural sciences (ICMNS)*. 2006. Bandung, Indonesia.
24. Wang, M., et al., *Isolation of new polyacetylenes from the roots of Eurycoma longifolia via high-speed counter-current chromatography*. Journal of Chromatography B, 2017. **1055-1056**: p. 39-44.

25. Meng, D., et al., *Four new quassinoids from the roots of Eurycoma longifolia Jack*. *Fitoterapia*, 2014. **92**: p. 105-110.
26. Low, B.-S., P.K. Das, and K.-L. Chan, *Standardized quassinoid-rich Eurycoma longifolia extract improved spermatogenesis and fertility in male rats via the hypothalamic–pituitary–gonadal axis*. *Journal of Ethnopharmacology*, 2013. **145**(3): p. 706-714.
27. BS, L., et al., *Physico-chemical effects of the major quassinoids in a standardized Eurycoma longifolia extract (Fr 2) on the bioavailability and pharmacokinetic properties, and their implications for oral antimalarial activity*. *Natural Product Communications*, 2011. **6**(3): p. 41-337.
28. Farouk, A. and A. Benafri, *Antibacterial activity of Eurycoma longifolia Jack. A Malaysian medicinal plant*. *Saudi Medical Journal*, 2007. **28**(9): p. 1422-1424.
29. Tran, T., et al., *NF-KB inhibitors from Eurycoma longifolia*. *Journal of Natural Products*, 2014. **77**(3): p. 483-488.
30. Husen, R., A.H.L. Pihie, and M. Nallappan, *Screening for antihyperglycaemic activity in several local herbs of Malaysia*. *Journal of Ethnopharmacology*, 2004. **95**(2–3): p. 205-208.
31. Chayan, P., et al., *Clinical Study of Chanta-lee-la Herbal Household Remedy*. *Journal of Thai Traditional and Alternative Medicine*, 2008. **6**(2): p. 212-218.
32. LBS, K., et al., *Cytotoxic and antimalarial constituents of the roots of Eurycoma longifolia*. *Journal of Natural Products*, 1991. **54**: p. 1360-1367.
33. S, H., et al., *Screening of selected indigenous plants of Cambodia for antiplasmodial activity*. *Journal of Ethnopharmacology*, 2006. **107**: p. 12-18.
34. Kanchanapoom, T., et al., *Quassinoids from Eurycoma harmandiana*. *Phytochemistry*, 2001. **57**(8): p. 1205-1208.
35. Bieri, S., et al., *Cocaine distribution in wild Erythroxylum species*. *Journal of Ethnopharmacology*, 2006. **103**(3): p. 439-447.
36. Rivier, L., *Analysis of alkaloids in leaves of cultivated Erythroxylum and characterization of alkaline substances used during coca chewing*. *Journal of Ethnopharmacology*, 1981. **3**(2): p. 313-335.

37. Johnson, E.L. and C.D. Foy, *Biomass accumulation and alkaloid content in leaves of Erythroxylum coca and Erythroxylum novogranatense var. novogranatense grown in soil with varying pH*. Journal of Plant Physiology, 1996. **149**(3): p. 444-450.
38. Brock, A., et al., *Calystegines in wild and cultivated Erythroxylum species*. Phytochemistry, 2005. **66**(11): p. 1231-1240.
39. Casale, J.F., J.R. Mallette, and L.M. Jones, *Chemosystematic identification of fifteen new cocaine-bearing Erythroxylum cultigens grown in Colombia for illicit cocaine production*. Forensic Science International, 2014. **237**: p. 30-39.
40. Novák, M., C.A. Salemink, and I. Khan, *Biological activity of the alkaloids of Erythroxylum coca and Erythroxylum novogranatense*. Journal of Ethnopharmacology, 1984. **10**(3): p. 261-274.
41. Hegnauer, R., *Chemotaxonomy of Erythroxylaceae (including some ethnobotanical notes on old world species)*. Journal of Ethnopharmacology, 1981. **3**(2): p. 279-292.
42. K, T., et al., *Acetophenone Diglycosides from Erythroxylum cambodianum*. Chemical and Pharmaceutical Bulletin, 2005. **53**(5): p. 579—581
43. T, S., O. A, and R. H, *Cuneatoside, a new megastigmane diglycoside from Erythroxylum cuneatum Blume.Kanchanapoom*. Journal of Asian Natural Products Research, 2006. **8**(8): p. 747-751.
44. Praman, S., et al., *Hypotensive and cardio-chronotropic constituents of Tinospora crispa and mechanisms of action on the cardiovascular system in anesthetized rats*. Journal of Ethnopharmacology, 2012. **140**(1): p. 166-178.
45. Ruan, C.-T., et al., *Hypoglycemic action of borapetoside A from the plant Tinospora crispa in mice*. Phytomedicine, 2013. **20**(8): p. 667-675.
46. Noor, H. and S.J.H. Ashcroft, *Pharmacological characterisation of the antihyperglycaemic properties of Tinospora crispa extract*. Journal of Ethnopharmacology, 1998. **62**(1): p. 7-13.
47. Haque, M.A., I. Jantan, and S.N. Abbas Bukhari, *Tinospora species: An overview of their modulating effects on the immune system*. Journal of Ethnopharmacology, 2017. **207**: p. 67-85.

48. Praman, S., et al., *Effects of an n-butanol extract from the stem of Tinospora crispa on blood pressure and heart rate in anesthetized rats*. Journal of Ethnopharmacology, 2011. **133**(2): p. 675-686.
49. Ruan, C.-T., et al., *Borapetoside C from Tinospora crispa improves insulin sensitivity in diabetic mice*. Phytomedicine, 2012. **19**(8): p. 719-724.
50. Chavan, T., et al., *Satwa from three Tinospora species exhibits differential hepatoprotective activity against repeated acetaminophen dosing in rats*. Journal of Pharmacy Research, 2013. **6**(1): p. 123-128.
51. Zhao Z, et al., *Authentication is fundamental for standardization of Chinese medicines*. Planta Medica, 2006. **72**(10): p. 865-874.
52. AJ, E. and M. LH, *An introduction to Plant Anatomy*, ed. n. ed. 1974, New York: McGraw-Hill.
53. Muller UG and W. LL, *AFLP genotyping and fingerprinting*. Trends in Ecology & Evolution, 1999. **14**: p. 389-340.
54. Liu, Z.J., *Chapter 19 - Amplified Fragment Length Polymorphism (AFLP)*, in *Stock Identification Methods*. 2005, Academic Press: Burlington. p. 389-411.
55. P, V., et al., *AFLP: a new techniques for DNA fingerprinting*. Nucleic Acids Research, 1995. **23**: p. 4407-4417.
56. El-Esawi, M.A., et al., *AFLP analysis of genetic diversity and phylogenetic relationships of Brassica oleracea in Ireland*. Comptes Rendus Biologies, 2016. **339**(5): p. 163-170.
57. de Faria-Tavares, J.S., et al., *Genetic relationships among accessions of mandacaru (Cereus spp.: Cactaceae) using amplified fragment length polymorphisms (AFLP)*. Biochemical Systematics and Ecology, 2013. **48**: p. 12-19.
58. Chao, C.-C.T., P.S. Devanand, and J. Chen, *AFLP analysis of genetic relationships among Calathea species and cultivars*. Plant Science, 2005. **168**(6): p. 1459-1469.
59. Techaprasan, J., S. Klinbunga, and T. Jenjittikul, *Genetic relationships and species authentication of Boesenbergia (Zingiberaceae) in Thailand based on*

- AFLP and SSCP analyses*. *Biochemical Systematics and Ecology*, 2008. **36**(5): p. 408-416.
60. Johnson, E.L., et al., *Identification of Erythroxylum taxa by AFLP DNA analysis*. *Phytochemistry*, 2003. **64**(1): p. 187-197.
 61. Bassam BJ, Caetano-Anollés G, and G. PM, *Fast and sensitive silver staining of DNA in polyacrylamide gels*. *Analytical Biochemistry*, 1991. **196**(1): p. 80-83.
 62. Organization, W.H.O., *Quality control methods for herbal materials*, ed. W.H.O.Q.c.m.f.h.m.G.W.P. 2011. 2011, Geneva: WHO Press.
 63. Chattopadhyay, N. and R. Maurya, *Herbal Medicine*, in *Reference Module in Biomedical Sciences*. 2015, Elsevier.
 64. Alves, I.A.B.S., et al., *Simaroubaceae family: botany, chemical composition and biological activities*. *Revista Brasileira de Farmacognosia*, 2014. **24**(4): p. 481-501.
 65. Ortiz RDC, Kellogg EA, and W. V, *Molecular phylogeny of the Moonseed family (Menispermaceae): implications for morphological diversification*. *American Journal of Botany*, 2007. **94**: p. 1425-1438
 66. Rooneyamarai W, et al., *Microscopic and molecular analyses of selected Morinda species in Thailand*. *Asian Pacific Journal of Tropical Medicine*, 2011. **6**(3): p. 118-126.
 67. Issaravanich S, et al., *Microscopic, molecular and scopolamine content evaluations of Datula Metel L. Var. Metel and D. Metel L. Var. Fastuosa in Thailand*. *Research Journal of Pharmaceutical, Biological and Chemical Sciences*, 2013. **4**(2): p. 1109-1121.
 68. Sihanat, A., et al., *Leaf constant numbers of selected Cassia species in Thailand*. *Bulletin of Health, Science and Technology*, 2015. **13**(2): p. 8-16.
 69. Tarang, A. and A.B. Gashti, *The power of microsatellite markers and AFLPs in revealing the genetic diversity of Hashemi aromatic rice from Iran*. *Journal of Integrative Agriculture*, 2016. **15**(6): p. 1186-1197.
 70. Sarin, B., J.P.M. Clemente, and A. Mohanty, *PCR-RFLP to distinguish three Phyllanthus sp., commonly used in herbal medicines*. *South African Journal of Botany*, 2013. **88**: p. 455-458.

71. Kasture, A., R. Krishnamurthy, and K. Rajkumar, *Genetic variation in the endangered Indian sweet flag (Acorus calamus L.) estimated using ISSR and RAPD markers*. Journal of Applied Research on Medicinal and Aromatic Plants, 2016. **3**(3): p. 112-119.
72. Jena, S.N., et al., *Genetic diversity and population structure of the mangrove lime (Merope angulata) in India revealed by AFLP and ISSR markers*. Aquatic Botany, 2015. **120**: p. 260-267.
73. Lucchini, V., *AFLP: a useful tool for biodiversity conservation and management*. Comptes Rendus Biologies, 2003. **326**: p. 43-48.
74. De Wet, H., M. Struwig, and B.E. Van Wyk, *Taxonomic notes on the genera Tiliacora and Tinospora (Menispermaceae) in southern Africa*. South African Journal of Botany, 2016. **103**: p. 283-294.
75. Ang, H.H., et al., *Quassinoids from Eurycoma longifolia*. Phytochemistry, 2002. **59**(8): p. 833-837.
76. Singh, K., et al., *Assessment of genetic diversity in Tinospora cordifolia by Inter Simple Sequence Repeats (ISSR) and Expressed Sequence Tagged- Simple Sequence Repeats (ETS-SSR)*. International Journal of Pharmacy and Pharmaceutical Sciences, 2014. **6**(10): p. 520-524.
77. Karihaloo, J.L., *DNA Fingerprinting Techniques for Plant Identification*, in *Plant Biology and Biotechnology: Volume II: Plant Genomics and Biotechnology*, B. Bahadur, et al., Editors. 2015, Springer India: New Delhi. p. 205-221.
78. Aichi-Yousfi, H., et al., *Genetic diversity and population structure of six species of Capparis in Tunisia using AFLP markers*. Comptes Rendus Biologies, 2016. **339**(11): p. 442-453.
79. Ghosh, S., P. Majumder, and S. Sen Mandi, *Species-specific AFLP marker for identification of Zingiber officinale, Z. montanum and Z. zerumbet [Zingiberaceae]*. Genetics and Molecular Research, 2011. **10**(1): p. 218-229.

APPENDIX

TableA1 Determination of stomatal number and stomatal index of *Erythroxylum novogranatense*

No.	ST Full	ST Half	ST SUM	ST x4	EP Full	EP Half	EP SUM	EP x4	S+E	SI
1	28	3	31	124	235	58	293	1172	1296	9.57
2	30	5	35	140	258	61	319	1276	1416	9.89
3	28	3	31	124	243	55	298	1192	1316	9.42
4	25	5	30	120	238	65	303	1212	1332	9.01
5	33	5	38	152	253	65	318	1272	1424	10.67
6	25	10	35	140	233	63	296	1184	1324	10.57
7	35	5	40	160	239	53	292	1168	1328	12.05
8	30	5	35	140	237	63	300	1200	1340	10.45
9	27	8	35	140	269	50	319	1276	1416	9.89
10	30	3	33	132	298	55	353	1412	1544	8.55
11	28	5	33	132	275	62	337	1348	1480	8.92
12	30	8	38	152	255	58	313	1252	1404	10.83
13	25	13	38	152	256	60	316	1264	1416	10.73
14	33	3	36	144	261	57	318	1272	1416	10.17
15	35	3	38	152	258	55	313	1252	1404	10.83
16	25	8	33	132	253	63	316	1264	1396	9.46
17	30	3	33	132	260	62	322	1288	1420	9.30
18	38	3	41	164	293	55	348	1392	1556	10.54
19	27	5	32	128	235	64	299	1196	1324	9.67
20	32	3	35	140	285	63	348	1392	1532	9.14
21	30	8	38	152	288	58	346	1384	1536	9.90
22	28	3	31	124	283	55	338	1352	1476	8.40
23	33	3	36	144	293	53	346	1384	1528	9.42
24	32	3	35	140	255	69	324	1296	1436	9.75
25	28	5	33	132	240	63	303	1212	1344	9.82
26	23	5	28	112	293	52	345	1380	1492	7.51
27	30	3	33	132	305	55	360	1440	1572	8.40
28	27	3	30	120	253	63	316	1264	1384	8.67
29	28	5	33	132	265	54	319	1276	1408	9.38
30	30	5	35	140	260	62	322	1288	1428	9.80
			Min	112					Min	7.51
			Max	164					Max	12.05
			Mean	137.6					Mean	9.69
			SD	12.46					SD	0.93

Table A2 Determination of stomatal number and stomatal index of *Erythroxylum cambodianum*

No.	ST Full	ST Half	ST SUM	ST x4	EP Full	EP Half	EP SUM	EP x4	S+E	SI
1	23	8	31	124	120	35	155	620	744	16.67
2	25	3	28	112	118	40	158	632	744	15.05
3	20	7	27	108	110	43	153	612	720	15.00
4	20	5	25	100	105	38	143	572	672	14.88
5	20	3	23	92	105	33	138	552	644	14.29
6	23	3	26	104	118	35	153	612	716	14.53
7	23	2	25	100	103	38	141	564	664	15.06
8	13	8	21	84	110	31	141	564	648	12.96
9	25	5	30	120	113	33	146	584	704	17.05
10	17	5	22	88	100	45	145	580	668	13.17
11	18	8	26	104	117	33	150	600	704	14.77
12	20	5	25	100	115	32	147	588	688	14.53
13	28	3	31	124	120	35	155	620	744	16.67
14	23	5	28	112	110	30	140	560	672	16.67
15	22	8	30	120	110	40	150	600	720	16.67
16	28	3	31	124	112	33	145	580	704	17.61
17	23	5	28	112	135	35	170	680	792	14.14
18	25	3	28	112	120	30	150	600	712	15.73
19	25	5	30	120	120	41	161	644	764	15.71
20	23	13	36	144	125	38	163	652	796	18.09
21	22	10	32	128	110	43	153	612	740	17.30
22	25	3	28	112	125	39	164	656	768	14.58
23	20	5	25	100	107	38	145	580	680	14.71
24	25	3	28	112	133	33	166	664	776	14.43
25	28	5	33	132	118	43	161	644	776	17.01
26	23	5	28	112	100	40	140	560	672	16.67
27	22	8	30	120	110	38	148	592	712	16.85
28	23	8	31	124	100	37	137	548	672	18.45
29	25	3	28	112	105	32	137	548	660	16.97
30	20	5	25	100	105	40	145	580	680	14.71
			Min	84					Min	12.96
			Max	144					Max	18.45
			Mean	111.87					Mean	15.70
			SD	13.31					SD	1.43

Table A3 Determination of stomatal number and stomatal index of *Erythroxylum cuneatum*

No.	ST Full	ST Half	ST SUM	ST x4	EP Full	EP Half	EP SUM	EP x4	S+E	SI
1	25	3	28	112	103	45	148	592	704	15.91
2	23	8	31	124	108	43	151	604	728	17.03
3	23	13	36	144	100	38	138	552	696	20.69
4	28	8	36	144	110	40	150	600	744	19.35
5	18	10	28	112	83	45	128	512	624	17.95
6	20	5	25	100	93	33	126	504	604	16.56
7	15	5	20	80	83	38	121	484	564	14.18
8	22	3	25	100	95	37	132	528	628	15.92
9	20	5	25	100	103	43	146	584	684	14.62
10	25	3	28	112	100	38	138	552	664	16.87
11	22	3	25	100	115	41	156	624	724	13.81
12	23	5	28	112	118	35	153	612	724	15.47
13	28	5	33	132	115	40	155	620	752	17.55
14	30	8	38	152	110	35	145	580	732	20.77
15	30	5	35	140	120	33	153	612	752	18.62
16	23	10	33	132	113	38	151	604	736	17.93
17	25	8	33	132	123	40	163	652	784	16.84
18	25	10	35	140	112	40	152	608	748	18.72
19	33	8	41	164	120	50	170	680	844	19.43
20	33	10	43	172	128	43	171	684	856	20.09
21	28	5	33	132	120	37	157	628	760	17.37
22	27	7	34	136	123	42	165	660	796	17.09
23	35	2	37	148	135	41	176	704	852	17.37
24	28	5	33	132	123	35	158	632	764	17.28
25	35	3	38	152	130	43	173	692	844	18.01
26	27	10	37	148	124	38	162	648	796	18.59
27	28	8	36	144	115	40	155	620	764	18.85
28	33	5	38	152	143	36	179	716	868	17.51
29	28	8	36	144	123	45	168	672	816	17.65
30	33	3	36	144	118	40	158	632	776	18.56
			Min	80					Min	13.81
			Max	172					Max	20.77
			Mean	131.20					Mean	17.55
			SD	21.69					SD	1.73

Table A4 Determination of stomatal number and stomatal index of *Tinospora crispa*

No.	ST Full	ST Half	ST SUM	ST x4	EP Full	EP Half	EP SUM	EP x4	S+E	SI
1	45	6	51	204	325	40	365	1460	1664	12.26
2	46	5	51	204	311	39	350	1400	1604	12.72
3	41	3	44	176	298	41	339	1356	1532	11.49
4	38	4	42	168	295	33	328	1312	1480	11.35
5	54	2	56	224	315	38	353	1412	1636	13.69
6	42	5	47	188	317	37	354	1416	1604	11.72
7	49	3	52	208	309	39	348	1392	1600	13.00
8	41	5	46	184	290	39	329	1316	1500	12.27
9	45	3	48	192	311	43	354	1416	1608	11.94
10	39	4	43	172	303	33	336	1344	1516	11.35
11	41	4	45	180	301	37	338	1352	1532	11.75
12	41	3	44	176	305	35	340	1360	1536	11.46
13	52	4	56	224	309	41	350	1400	1624	13.79
14	52	3	55	220	318	37	355	1420	1640	13.41
15	41	8	49	196	282	41	323	1292	1488	13.17
16	56	3	59	236	327	40	367	1468	1704	13.85
17	52	4	56	224	320	41	361	1444	1668	13.43
18	40	7	47	188	313	37	350	1400	1588	11.84
19	44	4	48	192	312	32	344	1376	1568	12.24
20	34	5	39	156	292	37	329	1316	1472	10.60
21	48	3	51	204	305	38	343	1372	1576	12.94
22	45	6	51	204	312	34	346	1384	1588	12.85
23	33	6	39	156	283	33	316	1264	1420	10.99
24	48	3	51	204	306	42	348	1392	1596	12.78
25	37	7	44	176	312	36	348	1392	1568	11.22
26	36	7	43	172	311	35	346	1384	1556	11.05
27	40	5	45	180	295	45	340	1360	1540	11.69
28	40	2	42	168	301	37	338	1352	1520	11.05
29	41	2	43	172	322	34	356	1424	1596	10.78
30	35	6	41	164	285	38	323	1292	1456	11.26
			Min	156					Min	10.60
			Max	236					Max	13.85
			Mean	190.40					Mean	12.13
			SD	21.65					SD	0.97

Table A5 Determination of stomatal number and stomatal index of *Tinospora baenzigeri*

No.	ST Half	ST SUM	ST x4	EP Full	EP Half	EP SUM	EP x4	S+E	SI
1	3	4	16	150	30	180	720	736	2.17
2	2	4	16	143	31	174	696	712	2.25
3	3	6	24	174	26	200	800	824	2.91
4	4	8	32	170	33	203	812	844	3.79
5	1	6	24	142	29	171	684	708	3.39
6	3	9	36	147	32	179	716	752	4.79
7	2	9	36	170	26	196	784	820	4.39
8	1	9	36	172	32	204	816	852	4.23
9	4	13	52	166	25	191	764	816	6.37
10	3	13	52	172	29	201	804	856	6.07
11	1	12	48	162	27	189	756	804	5.97
12	1	13	52	163	34	197	788	840	6.19
13	3	16	64	156	29	185	740	804	7.96
14	2	16	64	169	34	203	812	876	7.31
15	2	17	68	164	27	191	764	832	8.17
16	1	17	68	152	23	175	700	768	8.85
17	1	18	72	150	29	179	716	788	9.14
18	3	21	84	143	30	173	692	776	10.82
19	1	20	80	129	27	156	624	704	11.36
20	3	23	92	149	26	175	700	792	11.62
21	1	22	88	140	32	172	688	776	11.34
22	2	24	96	147	30	177	708	804	11.94
23	3	26	104	132	37	169	676	780	13.33
24	4	28	112	127	36	163	652	764	14.66
25	1	26	104	140	26	166	664	768	13.54
26	2	28	112	126	35	161	644	756	14.81
27	5	32	128	140	29	169	676	804	15.92
28	2	30	120	152	32	184	736	856	14.02
29	0	29	116	149	32	181	724	840	13.81
30	1	31	124	160	32	192	768	892	13.90
		Min	16					Min	2.17
		Max	128					Max	15.92
		Mean	70.67					Mean	8.83
		SD	34.75					SD	4.32

Table B1 Determination of Loss on drying / Total ash / Acid-insoluble ash of *Eurycoma logifolia* Jack

Source	No	W. of crucible and crude drug			Loss on drying			Total Ash			Acid insoluble ash		
		W. of crucible	W. of crude drug	Total	W hrs 14	W loss	%LOD	W of cru+Ash	W of Ash	%Total Ash	Cru+dissolve	W Ash	%AIA
1	1	30.1271	3.0002	33.1273	32.8817	0.2456	8.19	30.1867	0.0596	1.99	30.1532	0.0261	0.87
Chiang Mai	2	28.1745	3.0001	31.1746	30.9388	0.2358	7.86	28.2327	0.0582	1.94	28.2001	0.0256	0.85
	3	29.7503	3.0002	32.7505	32.5195	0.2310	7.70	29.8079	0.0576	1.92	29.7759	0.0256	0.85
2	4	32.4481	3.0003	35.4484	35.1880	0.2604	8.68	32.5251	0.0770	2.57	32.4753	0.0272	0.91
Nakhon Sawan	5	33.5771	3.0003	36.5774	36.3306	0.2468	8.23	33.6545	0.0774	2.58	33.6035	0.0264	0.88
	6	31.9437	3.0005	34.9442	34.6868	0.2574	8.58	32.0201	0.0764	2.55	31.9666	0.0229	0.76
3	7	29.2767	3.0006	32.2773	32.1129	0.1644	5.48	29.33	0.0533	1.78	29.2929	0.0162	0.54
Nakhon Pathom	8	33.5150	3.0002	36.5152	36.3592	0.1560	5.20	33.5692	0.0542	1.81	33.533	0.0180	0.60
	9	30.9941	3.0007	33.9948	33.8393	0.1555	5.18	31.0504	0.0563	1.88	31.013	0.0189	0.63
4	10	30.3314	3.0001	33.3315	33.1103	0.2212	7.37	30.401	0.0696	2.32	30.3487	0.0173	0.58
Uthai Thani	11	28.5849	3.0004	31.5853	31.3727	0.2126	7.09	28.6534	0.0685	2.28	28.6037	0.0188	0.63
	12	31.9877	3.0008	34.9885	34.7885	0.2000	6.66	32.0571	0.0694	2.31	32.0062	0.0185	0.62
5	13	32.6658	3.0016	35.6674	35.5006	0.1668	5.56	32.7314	0.0656	2.19	32.6939	0.0281	0.94
Ratchaburi	14	30.6275	3.0017	33.6292	33.4666	0.1626	5.42	30.6968	0.0693	2.31	30.6584	0.0309	1.03
	15	29.3967	3.0013	32.3980	32.2258	0.1722	5.74	29.4636	0.0669	2.23	29.4259	0.0292	0.97
6	16	33.9529	3.004	36.9569	36.7400	0.2169	7.22	33.9867	0.0338	1.13	33.9555	0.0026	0.09
Rayong	17	30.2159	3.0047	33.2206	33.0023	0.2183	7.27	30.2519	0.0360	1.20	30.2258	0.0099	0.33
	18	33.0092	3.0044	36.0136	35.7878	0.2258	7.52	33.0465	0.0373	1.24	33.0144	0.0052	0.17
7	19	28.8015	3.0079	31.8094	31.5856	0.2238	7.44	28.8382	0.0367	1.22	28.8061	0.0046	0.15
Kalasin	20	28.8623	3.0075	31.8698	31.6453	0.2245	7.46	28.8982	0.0359	1.19	28.871	0.0087	0.29
	21	30.1634	3.0053	33.1687	32.9385	0.2302	7.66	30.1997	0.0363	1.21	30.1677	0.0043	0.14
8	22	29.5056	3.0062	32.5118	32.2720	0.2398	7.98	29.5585	0.0529	1.76	29.5171	0.0115	0.38
Nong Khai	23	29.0386	3.0068	32.0454	31.8034	0.2420	8.05	29.0925	0.0539	1.79	29.0499	0.0113	0.38
	24	30.7965	3.0066	33.8031	33.5644	0.2387	7.94	30.8505	0.0540	1.80	30.8072	0.0107	0.36
9	25	30.3603	3.0059	33.3662	33.1100	0.2562	8.52	30.4305	0.0702	2.34	30.3829	0.0226	0.75
Ubonratchathani	26	35.5042	3.0060	38.5102	38.2589	0.2513	8.36	35.5741	0.0699	2.33	35.5273	0.0231	0.77
	27	31.9053	3.0055	34.9108	34.6540	0.2568	8.54	31.9737	0.0684	2.28	31.9301	0.0248	0.83
10	28	28.7078	3.007	31.7148	31.4786	0.2362	7.86	28.7696	0.0618	2.06	28.7319	0.0241	0.80
Surat Thani	29	30.0526	3.0076	33.0602	32.8144	0.2458	8.17	30.1151	0.0625	2.08	30.0749	0.0223	0.74
	30	29.8017	3.0075	32.8092	32.5844	0.2248	7.47	29.8651	0.0634	2.11	29.8273	0.0256	0.85
11	31	32.1862	3.0057	35.1919	34.9314	0.2605	8.67	32.2563	0.0701	2.33	32.2057	0.0195	0.65
Nakhon Si Thammar	32	28.5912	3.0059	31.5971	31.3444	0.2527	8.41	28.6622	0.0710	2.36	28.612	0.0208	0.69
	33	31.2863	3.0054	34.2917	34.0312	0.2605	8.67	31.3558	0.0695	2.31	31.3043	0.0180	0.60
12	34	29.4011	3.0075	32.4086	32.1583	0.2503	8.32	29.4716	0.0705	2.34	29.4374	0.0363	1.21
Chaokrompoe	35	32.767	3.0073	35.7743	35.5395	0.2348	7.81	32.8353	0.0683	2.27	32.8038	0.0368	1.22
	36	29.8842	3.0079	32.8921	32.6422	0.2499	8.31	29.9540	0.0698	2.32	29.918	0.0338	1.12
13	37	30.346	3.0075	33.3535	33.1266	0.2269	7.54	30.3835	0.0375	1.25	30.3576	0.0116	0.39
Vejpongso	38	28.8962	3.0074	31.9036	31.6930	0.2106	7.00	28.9330	0.0368	1.22	28.9137	0.0175	0.58
	39	32.4819	3.0088	35.4907	35.2827	0.2080	6.91	32.5192	0.0373	1.24	32.4921	0.0102	0.34
14	40	30.0546	3.0059	33.0605	32.8138	0.2467	8.21	30.1205	0.0659	2.19	30.0892	0.0346	1.15
Hua Heng	41	28.1735	3.0057	31.1792	30.9478	0.2314	7.70	28.2365	0.0630	2.10	28.2048	0.0313	1.04
	42	29.3700	3.0052	32.3752	32.1272	0.2480	8.25	29.434	0.0640	2.13	29.4024	0.0324	1.08
15	43	32.5315	3.0027	35.5342	35.3002	0.2340	7.79	32.5967	0.0652	2.17	32.5572	0.0257	0.86
Sapandam	44	33.1933	3.0028	36.1961	35.9834	0.2127	7.08	33.2549	0.0616	2.05	33.2193	0.0260	0.87
	45	29.2907	3.0029	32.2936	32.0795	0.2141	7.13	29.3546	0.0639	2.13	29.3162	0.0255	0.85

Table B2 Determination of water-soluble extractive of *Eurycoma longifolia* Jack

Sources	No.	W.of Crude drug	W.of beaker	W.of extractable matter+beakers	W.of extractable matter	% yeild
1	1	5.0013	30.6456	30.6995	0.0539	5.388599
Chiang Mai	2	5.0012	29.0963	29.1403	0.044	4.398944
	3	5.0015	29.7755	29.8304	0.0549	5.488353
2	4	5.0016	32.3516	32.3937	0.0421	4.208653
Nakorn Sawan	5	5.002	32.4761	32.5202	0.0441	4.408237
	6	5.0025	28.9706	29.0125	0.0419	4.187906
3	7	5.0039	32.093	32.1456	0.0526	5.2559
Nakorn Patom	8	5.0028	32.6675	32.7269	0.0594	5.936675
	9	5.0069	29.2173	29.2728	0.0555	5.542352
4	10	5.0078	29.2508	29.3135	0.0627	6.260234
Uthai Thani	11	5.0092	29.8169	29.8786	0.0617	6.158668
	12	5.0081	29.4366	29.4969	0.0603	6.020247
5	13	5.0032	30.0397	30.088	0.0483	4.826911
Ratchaburi	14	5.0051	32.043	32.0928	0.0498	4.974926
	15	5.002	29.2855	29.3324	0.0469	4.688125
6	16	5.0092	31.5445	31.5996	0.0551	5.49988
Rayong	17	5.0064	29.2737	29.3258	0.0521	5.20334
	18	5.0056	29.1732	29.2186	0.0454	4.534921
7	19	5.0039	32.386	32.4409	0.0549	5.485721
Kalasin	20	5.0046	30.6279	30.6868	0.0589	5.884586
	21	5.0055	32.4955	32.5501	0.0546	5.454001
8	22	5.0025	29.1772	29.2333	0.0561	5.607196
Nong Khai	23	5.0047	32.4967	32.5539	0.0572	5.714628
	24	5.0077	29.6457	29.7104	0.0647	6.460052
9	25	5.0044	29.6832	29.7344	0.0512	5.115498
Ubon Ratchathani	26	5.0061	30.358	30.4006	0.0426	4.254809
	27	5.0065	29.0084	29.0537	0.0453	4.524119
10	28	5.002	32.8305	32.8714	0.0409	4.088365
Surat Thani	29	5.0048	29.0594	29.1008	0.0414	4.136029
	30	5.0044	31.4857	31.5186	0.0329	3.287107
11	31	5.0015	30.5722	30.6108	0.0386	3.858842
akhon Si Thammar	32	5.0014	32.3754	32.4256	0.0502	5.018595
	33	5.0016	32.4475	32.4954	0.0479	4.788468
12	34	5.0013	32.1546	32.2061	0.0515	5.148661
Chaokrapoe	35	5.0019	32.4294	32.4811	0.0517	5.168036
	36	5.0014	33.0349	33.0827	0.0478	4.778662
13	37	5.0019	29.1066	29.1391	0.0325	3.248765
Vejpongsoot	38	5.0026	29.4281	29.463	0.0349	3.488186
	39	5.0027	32.8087	32.8455	0.0368	3.678014
14	40	5.003	29.3744	29.4259	0.0515	5.146912
Hua Heng	41	5.0048	45.5858	45.6406	0.0548	5.474744
	42	5.0039	54.0706	54.1225	0.0519	5.185955
15	43	5.0012	32.7205	32.7577	0.0372	3.719107
Sapandam	44	5.0012	29.1611	29.1994	0.0383	3.829081
	45	5.0014	31.5113	31.5557	0.0444	4.438757

Table B3 Determination of ethonol-oluble extractive of *Eurycoma longifolia* Jack

Sources	No.	W.of Crude drug	W.of beaker	W.of extractable matter+beakers	W.of extractable matter	% yeild
1	1	5.0028	28.0624	28.0859	0.0235	2.348685
Chiang Mai	2	5.0035	32.7101	32.7327	0.0226	2.258419
	3	5.0033	32.2001	32.2231	0.023	2.298483
2	4	5.0015	30.1019	30.114	0.0121	1.209637
	5	5.0029	30.9932	31.0052	0.012	1.199304
Nakorn Sawan	6	5.0027	32.2235	32.2343	0.0108	1.079417
	7	5.0029	29.986	30.0041	0.0181	1.808951
Nakhon Pathom	8	5.0028	32.5534	32.563	0.0096	0.959463
	9	5.0032	29.2083	29.2254	0.0171	1.708906
4	10	5.0034	30.0157	30.0425	0.0268	2.678179
	11	5.0024	33.1358	33.1571	0.0213	2.128978
Uthai Thani	12	5.0015	29.0185	29.0461	0.0276	2.759172
	13	5.0015	29.5306	29.5428	0.0122	1.219634
Ratchaburi	14	5.0017	30.5824	30.5948	0.0124	1.239579
	15	5.0016	31.9901	32.0033	0.0132	1.319578
6	16	5.0033	31.2377	31.2475	0.0098	0.979354
	17	5.0035	29.1517	29.1635	0.0118	1.179175
Rayong	18	5.0021	31.5815	31.5935	0.012	1.199496
	19	5.0005	32.759	32.7858	0.0268	2.679732
7	20	5.003	29.2521	29.2796	0.0275	2.748351
	21	5.0031	29.1865	29.2103	0.0238	2.378525
8	22	5.0017	30.9163	30.9372	0.0209	2.08929
	23	5.0036	29.1921	29.1995	0.0074	0.739468
Nong Khai	24	5.0022	30.4962	30.5135	0.0173	1.729239
	25	5.0025	33.1089	33.1284	0.0195	1.949025
9	26	5.001	31.3267	31.3453	0.0186	1.859628
	27	5.0014	29.6186	29.6225	0.0039	0.389891
10	28	5.0027	30.3305	30.3457	0.0152	1.51918
	29	5.0025	33.0271	33.0422	0.0151	1.509245
Surat Thani	30	5.0023	28.9633	28.9781	0.0148	1.47932
	31	5.0011	29.3999	29.4132	0.0133	1.329707
11	32	5.0024	30.1285	30.1409	0.0124	1.239405
	33	5.002	31.357	31.37	0.013	1.29948
12	34	5.0023	29.1172	29.1352	0.018	1.799172
	35	5.0018	30.2953	30.3125	0.0172	1.719381
Chaokrompoe	36	5.0025	30.528	30.5463	0.0183	1.829085
	37	5.0016	30.684	30.7025	0.0185	1.849408
13	38	5.0008	29.2944	29.3127	0.0183	1.829707
	39	5.001	31.5643	31.5841	0.0198	1.979604
14	40	5.0018	31.2399	31.2579	0.018	1.799352
	41	5.0022	30.517	30.5346	0.0176	1.759226
Hau Heng	42	5.0019	30.7094	30.7286	0.0192	1.919271
	43	5.0025	30.2154	30.2218	0.0064	0.63968
15	44	5.0024	30.5249	30.5398	0.0149	1.489285
	45	5.002	29.4402	29.4423	0.0021	0.209916



VITA

Mr. Somdet Katib was born on January 10, 1986 in Chiang Kham District, Phayao Province, Thailand. He got a Bachelor's degree of Applied Thai Traditional Medicine (Applied Thai Traditional Medicine), second class honor from School of Health Science, Mae Fah Luang University, Thailand in 2008.

Publication

Katib, S., Ruangrunsi, N., Palanuvej, C., Chareonsap, PP., Rungsihirunrat, K.

Macroscopic-Microscopic Characteristics and AFLP Marker for Identification of *Tinospora criapa* and *Tinospora baenzigeri* endemic to Thailand. *Journal of Health Research*. 2015;31(2):143-149.

Oral presentation

Katib, S., Ruangrunsi, N., Palanuvej, C., Chareonsap, PP., Rungsihirunrat, K.

Macroscopic and Microscopic Identification and Phylogenetic Relationship of Selected *Tinospora* Species Endemic to Thailand. The 1st Mae Fah Luang University International Conference 2016 on Advance in Medical and Health Sciences and Kaleidoscope of Traditional and Complementary Medicine. 23-25 November 2016. Mae Fah Luang University, Chiang Rai, Thailand.

Scholarships

1. The scholarships for the Ph.D. programme, Mae Fah Luang University.
2. The 90th Anniversary of Chulalongkorn University Fund (Ratchadaphiseksomphot Endowment Fund).