

CHAPTER I INTRODUCTION

Because of the non-renewable nature of petroleum-based energy resources, their increasing demand has never met the realistic supply and tends to outrun the resource itself. Accompanied with the rise in greenhouse emissions caused by the combustion processes, the global warming is getting more serious. Therefore the new environmentally-friendly energy resources have been receiving much attention in order to reduce the global problems, and fuel cells turn out to be a promising solution.

1.1 Fuel Cells

Fuel cells are a device generating electricity with cleanest and high efficiency. Since there is no combustion during the operation, there are none of the pollutants. For systems planned to use hydrogen directly, they produce only electricity, water and heat.

The most common classification of fuel cells is by the type of electrolyte used in the cells. The five major types of fuel cells are alkaline fuel cell (AFC), polymer electrolyte membrane fuel cell (PEMFC), phosphoric acid fuel cell (PAFC), molten carbonate fuel cell (MCFC), and solid oxide fuel cell (SOFC). Table 1.1 provides a comparison between various fuel cells.

Table 1.1 Types of fuel cells [1]

Type	AFC	PEMFC	PAFC	MCFC	SOFC
Electrolyte	Alkaline solution	Polymer	Phosphoric acid	Molten carbonate	Oxide
Charge carrier	OH^-	H^+	H^+	CO_3^-	O^{2-}
Operating Temp. (°C)	70-90	70-200	180-200	650-700	800-1000
Fuel	H_2	H_2	H_2	H_2, CO	Hydrocarbon, H_2, CO
Efficiency (%)	30	40-50	40-50	50-60	50-60



1.2 Solid Oxide Fuel cells (SOFCs)

SOFCs are devices that electrochemically convert chemical energy into electrical energy directly without the need of combustion. They are all-solid-state system and high operating temperatures (up to 1000°C). The major advantage of SOFCs over other fuel cells is the fuel adaptability. SOFCs can be run on a variety of fuels such as hydrogen, natural gas, diesel, gasoline, methane, butane, etc, while other fuel cells operate with pure hydrogen.

1.2.1 Operation of SOFCs

The SOFC single cell is constructed with dense electrolyte which is sandwiched between a porous anode and a porous cathode, as shown in Figure 1.1. During the SOFC operation, fuel is fed to the anode, where an oxidation reaction takes place and releases electrons to the external circuit, whereas oxidant, normally oxygen or air, is fed to the cathode. Considering the electrode reactions, the cathodic reaction is the electrochemical reaction of gaseous oxygen into oxide ion while the dissociation of gaseous H_2 takes place on the anode. The resulting products include water, carbon dioxide, heat and electrons. In order to minimize voltage losses and maximize power densities, kinetics of reaction, ionic and molecular transport must be taken into account.

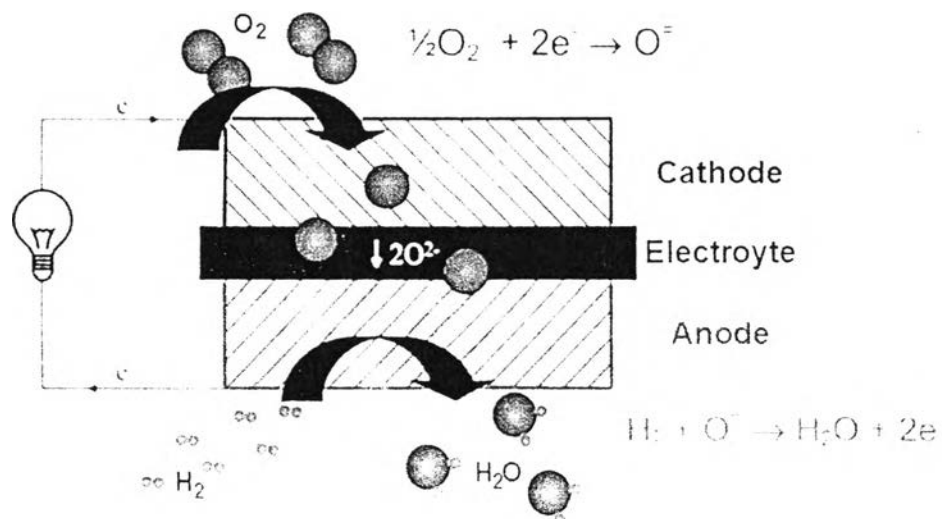

Figure 1.1 SOFC operation scheme [2]



1.2.2 Materials in SOFCs

The problem of SOFC operated at intermediate temperature (600-800°C) is the decline of performance because of low ionic conductivity of electrolyte and strong cathode polarization. To solve this problem, the alternative electrode and electrolyte materials are considerable to be used. Therefore, it is necessary to select materials which have the properties such as conducting property and thermal expansion property for the requirement of each component of SOFC.

1.2.2.1 Electrolyte

The requirements of electrolytes material are high ionic conductivity, low electronic conductivity, stable in both reducing and oxidizing atmosphere over a wide range of oxygen partial pressure, and good thermal and mechanical properties. The electrolyte materials commonly used for SOFC are yttria-stabilized zirconia (YSZ), gadolinium- or samarium-doped ceria (GDC or SDC) and strontium, magnesium-doped lanthanum gallate (LSGM).

Each electrolyte offers advantages and disadvantages. YSZ, the most popular electrolyte, is now being used at high-temperature operating condition due to its good ionic conductivity. Since, it shows poor conductivity at lower temperature, another electrolyte operates at lower temperature are considerable interest. For example, ceria doped with rare earth metals has higher ionic conductivity and lower activation energy than YSZ, but the main problem of this material is the reduction of Ce^{4+} to Ce^{3+} at low oxygen partial pressure resulting in the introduction of electronic conductivity which decreases the cell efficiency [3]. LSGM, the perovskite oxide electrolyte, is stable without electronic conductivity in a wide range of oxygen partial pressures. It also shows high ionic conductivity at intermediate temperature compared to YSZ. Nevertheless, the high cost of Ga_2O_3 becomes an obstacle for the commercialization prospects of LSGM. The comparative conductivity of YSZ, GDC and LSGM are showed in Figure 1.2.



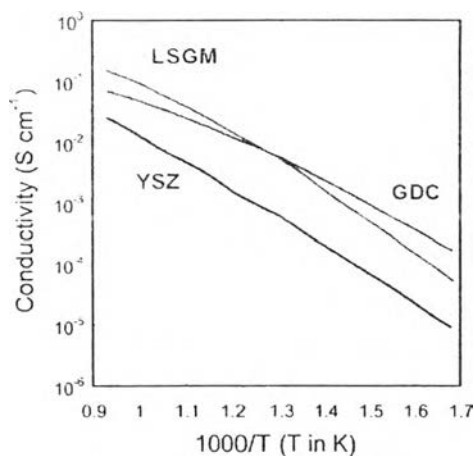

Figure 1.2 Conductivity of YSZ, GDC and LSGM [4]

Moreover the choice of electrolyte materials is also limited by thermal expansion coefficient (TEC). The TEC value of electrolyte must be matched to the electrode in order to avoid cracking. The TEC values for YSZ, GDC and LGSM are listed in Table 1.2.

Table 1.2 Thermal expansion coefficients of various electrolytes

Electrolyte	TEC ($1/^\circ\text{C}$)
YSZ	10.3×10^{-6} (30-1000°C) [5]
GDC	12.4×10^{-6} (30-1000°C) [6]
LSGM	9.78×10^{-6} (25-1000°C) [7]

1.2.2.2 Anode

Transition metals are good candidates as anode materials in SOFC. They may be classified with respect to H_2 oxidation rate as follows:



Among all transition metals, Ni is a popular choice of anode material because of its high catalytic activity and relatively low cost. However the high TEC value of nickel is a problem for using with YSZ electrolyte. The solution is by using the composite anode between nickel oxide and YSZ to give Ni-YSZ cermet. This composite anode provides both good ionic and electronic conductivity (from YSZ and Ni) and shows stable performance with H_2 fuel. However direct use of

hydrocarbon fuel leads to a strong adsorption of H₂S on the Ni particles resulting in the enhancement of the degree of activation polarization and performance loss [8]. Thus many alternatives have been proposed to overcome this problem such as using copper instead of nickel in the cermet and the development of novel anode materials.

Anode material requirements for SOFC can be summarized as follow:

- High catalytic activity for oxidation reaction of fuel gases
- Stability in low oxygen partial pressures
- Good chemical stability against the electrolyte and interconnect at high temperatures
- Tolerance to carbon cracking or sulfur impurities when using hydrocarbon fuels

1.2.2.3 Cathode

Generally, the main reaction occurring at the cathode is the reduction of gaseous oxygen into oxide ion. The mechanism of the reaction can be described as follow [9]:

- i) Oxygen surface adsorption and dissociation by breaking the covalent bond of O₂ molecules
- ii) Reduction of O species into oxide ions, O²⁻
- iii) Oxide ion transfer within the bulk cathode
- iv) Oxide ion transport across the cathode/electrolyte interface

The oxygen reduction reaction plays a crucial role in the kinetics of SOFCs due to the major contribution to the activation polarization. Therefore, lots of research has gained much attention to the development of SOFC cathode material in order to reduce this polarization.

The choice of this material can be summarized as follows [10]:

- Chemical stability during cell operation
- High electronic conductivity
- Thermal expansion match with other cell components
- Minimum reactivity with electrolyte
- Sufficient porosity to facilitate transport of oxygen molecule



Conventional cathode materials used in SOFC are lanthanum-based perovskite materials, $\text{La}_{1-x}\text{Sr}_x\text{MnO}_3$ (LSM). They are only electronic conductors having high electronic conductivity, good stability and moderate thermal expansion coefficients (TEC) compatible to common electrolyte such as YSZ, which make LSM considered as the state-of-the-art cathode materials for SOFCs operating at high temperature (~ 1000 °C). However, the reduction of oxygen of this kind of cathode is limited to a narrow region called three-phase boundary (TPB) where air, electrode and electrolyte are in contact, as shown in Figure 1.3. Therefore, in order to extend the electrochemically active region from the limited TPB, mixed ionic and electronic conductors (MIECs) are required. Perovskite-type mixed ionic-electronic conducting oxides including simple perovskites, double ordered perovskites and Ruddlesden-Popper phases, have been widely studied as potential cathodes for IT-SOFC.

(a) Pure electronic conductor

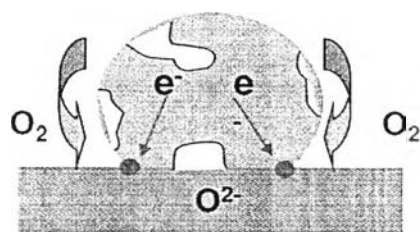

Electrochemically active in the TPB, requires very high temperatures (LSM)

(b) MIECs

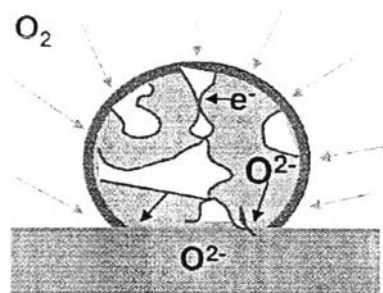

Great enhancement of the active area. Reduction of the working temperature.

Figure 1.3 Active areas for oxygen reduction reaction [11]

The desired properties and processing requirements for SOFC single cell component are summarized in Table 1.3.

Table 1.3 Micro-structural and property of SOFC component [12]

	Anode	Electrolyte	Cathode
Microstructure	Porous, many TPBs, stable to sintering	Dense, thin, free of cracks and pinholes.	Porous, many TPBs, stable to sintering.
Electrical	Electronically and preferably ionically conductive.	Ionically but not electronically conductive.	Electronically and preferably ionically conductive.
Chemical	Stable in fuel atmosphere; preferably also stable in air for redox tolerance. Catalytic for oxidation and performing but not for carbon deposition.	Stable in both oxidizing and reducing environment. Minimal reduction and resulting electronic conductivity in reducing conditions.	Stable in air environments. Catalytic for oxygen reduction. Resistance to performance loss caused by chromium deposition.
Thermal expansion	Compatible with other layers, especially electrolyte.	Compatible with other layers, especially structural support layer.	Compatible with other layers, especially electrolyte.
Chemical compatibility	Minimal reactivity with electrolyte and interconnect.	Minimal reactivity with anode and cathode.	Minimal reactivity with electrolyte and interconnect.

1.3 Perovskite

Materials based on simple perovskite such as LaCoO_3 , BaCoO_3 or LaFeO_3 have attracted extensive attention due to the possible use as cathode materials for IT-SOFC. Their general formula is defined as ABX_3 where A (alkaline or alkaline earth metal) is a large cation in twelve fold coordination of X atoms, B (transition metal) is a smaller cation in octahedral coordination of X atoms. The Ideal perovskite structure is cubic and consists of a framework of corner-sharing BX_6 octahedral with the A cation located at the body center of the cube as shown in Figure 1.4. The



combination of perovskite (ABX_3) and rock salt (AX) framework results in a complex structural type, Ruddlesden-Popper (RP) structure.

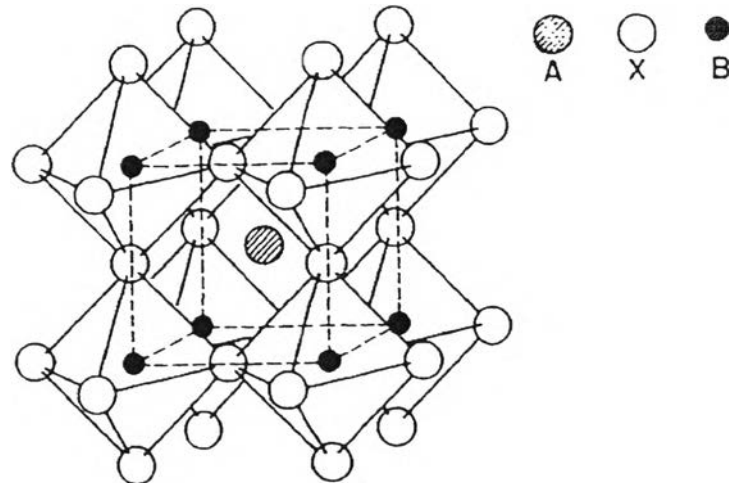

Figure 1.4 The perovskite structure (ABX_3) [13]

The K_2NiF_4 structure having the chemical formula A_2BX_4 is the first member of the RP series $(AX)(ABX_3)_n$ for $n \geq 1$. This structure has a cubic perovskite $(ABX_3)_n$ layer alternating with an insulating rock salt AX layer along the c axis [14], as depicted in Figure 1.5. A repeat distance in layers leads to an ideal tetragonal structure with the space group $I4/mmm$. When the K_2NiF_4 structure tends to stoichiometric, the octahedra can be tilted to relieve structural stresses in the system. However, the oxygen interstitials occurring on the rock salt layer prevent the tilting of octahedra, leading to the various phases of the K_2NiF_4 structure.

Several recent studies have highlighted A_2BO_4 oxides because these oxides can accommodate oxygen excess by the incorporation of interstitial oxygen (mainly in the rock salt layer) or generate lots of oxygen vacancy (mainly in the perovskite layer). This seems to improve the oxygen transport properties compared to simple perovskite.



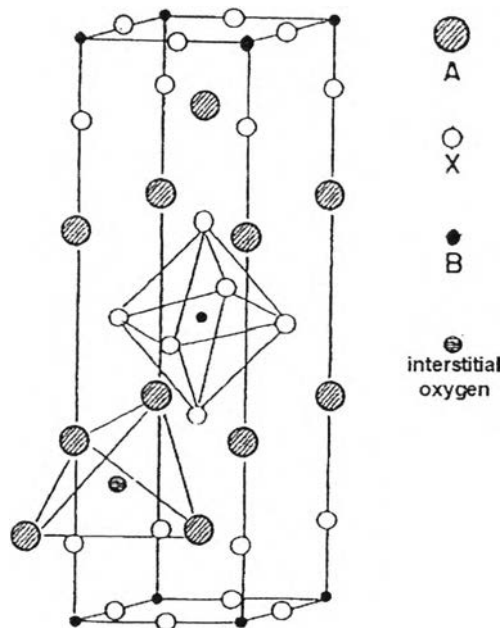

Figure 1.5 The A_2BO_4 structure showing the location of an interstitial oxygen atom [15]

Perovskites exhibit a wide range of magnetic and electrical behavior because many different ions can be combined into the structure so long as electrical neutrality is preserved. The Goldschmidt's tolerance factor (t) [16] as expressed in equation 1.1 is used to determine the degree of a combination of cations and anions which are feasible based on bond distances.

$$t = \frac{(r_A + r_O)}{\sqrt{2} \times (r_B + r_O)} \quad (1.1)$$

where r_A , r_B and r_O represent the ionic crystal radii of A-site cation, B-site cation and oxygen ion, respectively. The derivation of the tolerance factor is presented in Figure 1.6.

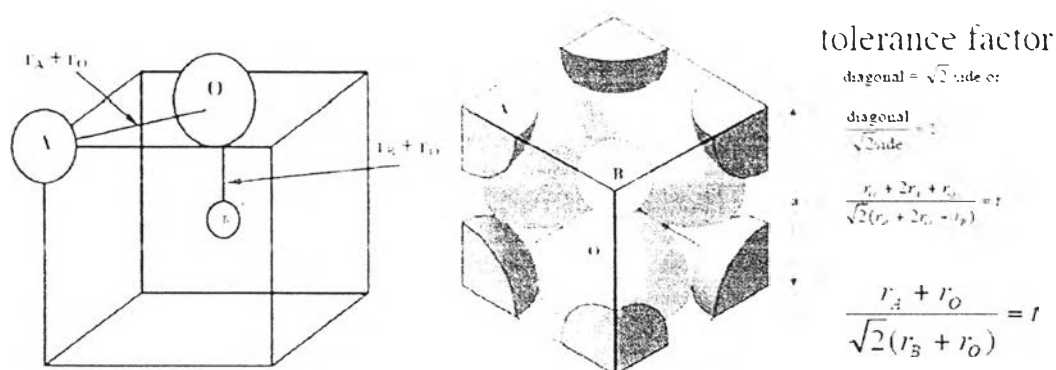

Figure 1.6 Derivation of the tolerance factor [17]

If $0.75 < t < 1.0$, the ions selected should be able to form a perovskite structure. When $t=1$, there are no stresses in the system, the perovskite is an ideal cubic. The cubic structure can be maintained with $0.95 < t < 1.04$, while $0.75 < t < 0.9$ low-symmetry orthorhombic or tetragonal structure will be obtained.

1.4 Electrical conductivity

The electrical conductivity (σ) [18] is one significant factor in the cathode performance. It can be calculated from the equation:

$$\sigma = nq\mu \quad (1.2)$$

Where n is the charge carrier concentration (cm^{-3}), q is the charge (in coulombs), and μ is the mobility of the charge carrier ($\text{cm}^2 \text{s}^{-1} \text{V}^{-1}$). The unit of σ is normally expressed in $\text{S} \cdot \text{cm}^{-1}$.

For perovskite oxides, their electrical conductivity is composed of two mechanisms, electronic and ionic conduction, because there are both electronic holes and oxygen vacancies appeared in the crystal structure. Generally, the electronic conduction is much higher than ionic conduction, thus the electrical conductivity values obtained are used to determine the electronic conductivity.

The electronic conductivity in perovskite oxides related to mobile charge carriers (excess electrons/electron holes) along the B-O-B chains. The electron/hole exchange causes by the overlapping of the orbitals of oxide ion and adjacent B-site cation as displayed in Figure 1.7. The higher the concentration of the mobile charge

carriers is, the higher the conductivity obtains. Generally, the generation of mobile charge carrier is by the replacement of trivalent cations with divalent cations at the A site. This leads to the reduction of total positive charge in the structure. Thus the increase in valence of the B cation (electronic compensation) or the generation of oxygen vacancies (ionic compensation) is occurred. However, the appearance of each type of charge compensation is undesirable because it is related to many factors including the temperature, the oxygen partial pressure, the type and concentration of dopants, the microstructure, etc.

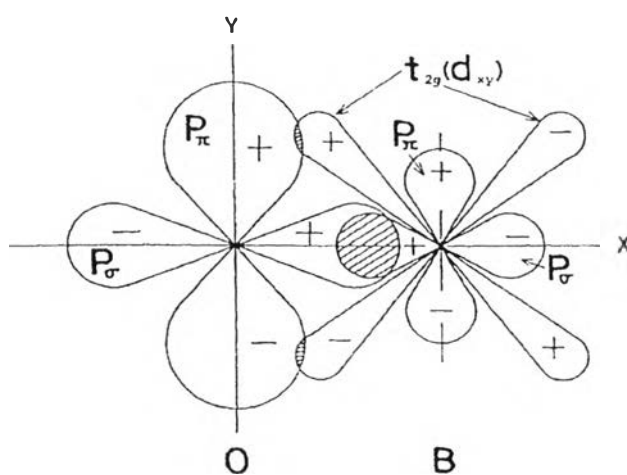

Figure 1.7 Covalent bonds between anionic p orbital and t_{2g} orbital of B-site cation [19]

For ionic conductivity, it is not only affected by the formation of oxygen vacancies and interstitial oxygen, it is also dependent on the critical radius (r_{cr}) [16], as expressed in equation 1.3. This factor corresponds to the maximum ionic radius of mobile ion to pass through the saddle point.

$$r_{cr} = \frac{a_0 \left(\frac{3}{4} a_0 - \sqrt{2} r_B \right) + r_B^2 - r_A^2}{2(r_A - r_B) + \sqrt{2} a_0} \quad (1.3)$$

where r_A and r_B are the ionic radius of the A ion and B ion, respectively, and a_0 is the crystal parameter. The critical radius is normally less than 1.10 Å which is smaller than the ionic radius of oxygen ion.

The saddle point for oxygen ion migration is formed by two A-site cations and one B-site cation. The migration of the oxygen ion is by jumping from one site to the adjacent vacancy along the anion octahedral edge (Figure 1.8).

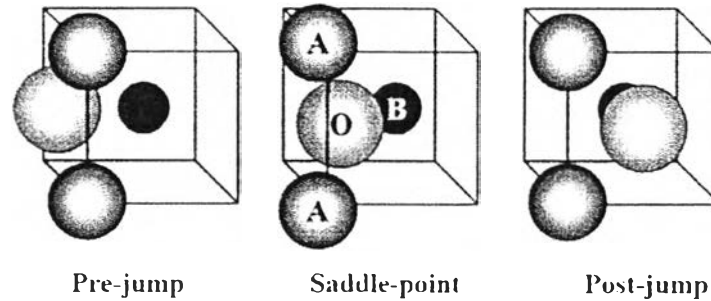

Figure 1.8 The migration of the oxygen ion passes through the saddle point [19]

1.5 Current-Voltage characterization

Figure 1.9 shows a current-voltage (I-V) curve in SOFC. Normally, the actual cell voltage is less than theoretical reversible voltage. The decrease of the cell voltage under current load depends on current density and many factors such as electrode or electrolyte materials, microstructure of the electrodes, temperature, etc. The difference between the theoretical reversible voltage and the actual cell voltage gives a polarization loss or over-potential (η) [20]. In the fuel system, there are three polarization losses:

- Activation polarization (η_{Act})
- Ohmic polarization (η_{Ohm})
- Concentration polarization (η_{Con})

The output power density, P is expressed as the product of cell voltage and current density:

$$P = iE \quad (1.4)$$



It can be seen from this equation that the power density equals zero at very low and very high current densities. Therefore the maximum power density is obtained between these two extremes (Figure 1.10).

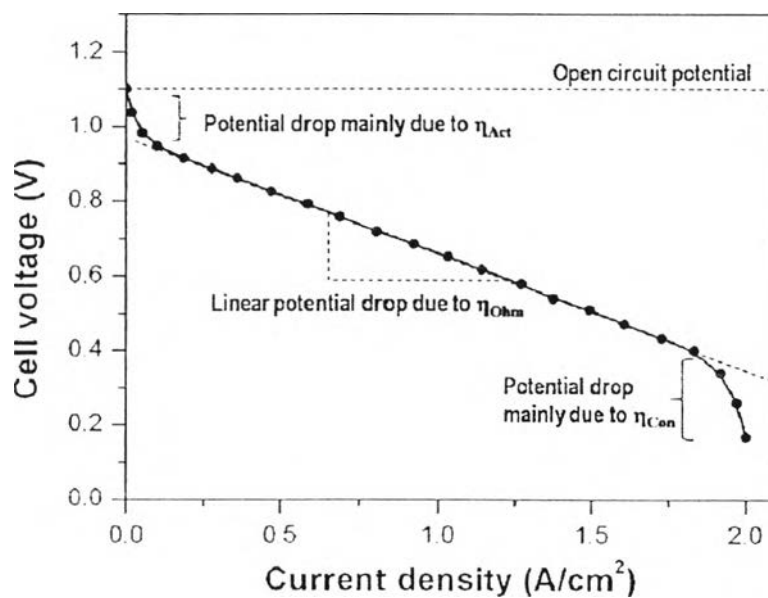

Figure 1.9 Characteristics of a typical current-voltage curve in SOFC [21]

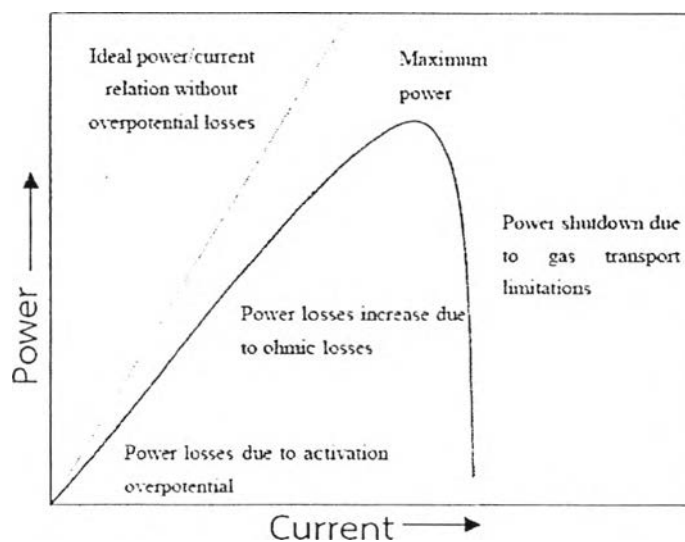

Figure 1.10 Typical power/current relation [21]

1.6 Electrochemical Impedance Spectroscopy (EIS) characterization

EIS is used to determine the polarization resistance in this study. It is measured by applying a small signal AC voltage over a wide frequency range and collecting the output current. The impedance (Z) is the ratio of the applied sinusoidal voltage and the resulting sinusoidal current, as related to Ohm's Law [22] in equation 1.5.

$$z = \frac{E(\omega)}{I(\omega)} = \frac{E_0 \cos(\omega t)}{I_0 \cos(\omega t - \varphi)} = Z_0(\cos \varphi + j \sin \varphi) \quad (1.5)$$

Data obtained from the experiment are displayed in the form of Nyquist plot as shown in Figure 1.11. The x and y axes of this plot are the real and the imaginary parts of impedance, respectively. Moreover the circuit elements consisting of capacitor, resistor and inductance are used to describe some physical aspects of the system.

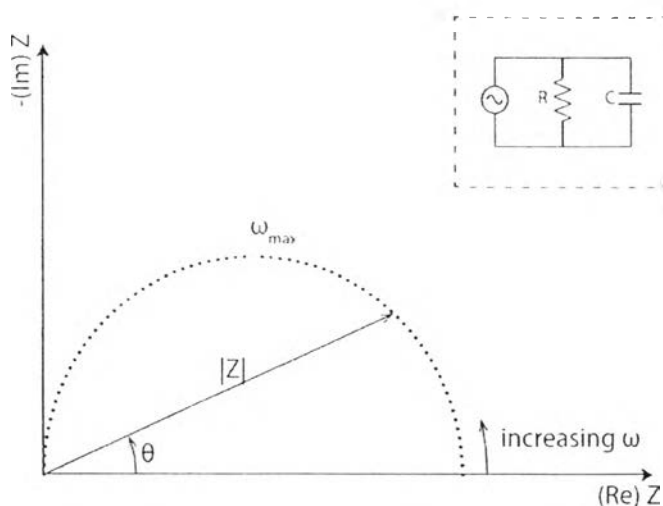

Figure 1.11 Schematic of a Nyquist plot [23]

1.7 Literature reviews

Solid oxide fuel cells (SOFCs) are the energy sources of current interest because they offer high power efficiency and low production of pollutants. To reduce its drawback in high temperature operation (800-1000°C), new cathode

materials with high electro-catalytic activity for IT-SOFC (600-800°C) have been developed.

The K_2NiF_4 -type or A_2BO_4 oxides, a two dimensional layered structure of insulating rock-salt (AO) separated by cubic perovskite (ABO_3) layers, have been widely studied because of their excellent mixed conductivity and catalytic activity. There are a lot of publications concerning the properties of this kind of cathode. La_2NiO_4 , one of the K_2NiF_4 -type oxides, is an interesting material which exhibits high mixed oxide ionic and electronic conductivity. It has high thermal stability and good catalytic activity. However there are many researchers trying to improve its properties. The partial substitution of metal ions on La_2NiO_4 shows a positive effect on the cathode performance, for example, substitution with Co ions 10 mole percent at the B-site and Sr ions 40 mole percent at the A-site can improve ionic and electronic conductivity [24, 25], respectively. Therefore, the development of $La_{1.6}Sr_{0.4}NiO_4$ (LSN), $La_{1.6}Sr_{0.4}Ni_{0.9}Co_{0.1}O_4$ (LSNC) and $La_2Ni_{0.9}Co_{0.1}O_4$ (LNC) is of interest in this work.

Cherry et al. [26] studied on $La_{1-x}(AE)_xCoO_3$ (AE =Ca, Mg, Sr, Ba). They found that substitution of $LaCoO_3$ with Ca and Sr, the oxygen vacancies were easy generated compared to substitution with Mg and Ba. These vacancies facilitated ionic conductivity.

Yang et al. [27] reported that substitution with Sr had an influence on the sintering densification and electrical conductivity of Pr_2NiO_4 . As Sr content increased, the compounds became denser and their electrical conductivity increased. However, the limitation of Sr addition in $Pr_{2-x}Sr_xNiO_4$ was less than $x=0.8$.

Zhao et al. [28] studied the polarization resistance (R_p) of $La_{2-x}Sr_xCo_{0.8}Ni_{0.2}O_4$ -GDC composite. The results showed that the introduction of Sr at the A-site had an effect on the reduction of R_p . Doping with Sr 80 mole percent, the R_p was 26 times lower than the R_p of the undoped one which implied to the increasing of electron hole when Sr-doping level was increased.

Shen et al. [29] studied the electrical conductivity of Ca-doped La_2NiO_4 . They found that Ca doping promoted the elongation of La-O bond length providing more space in La_2O_2 rock salt layers which facilitate the migration of oxide ion. Moreover, the activation energy of oxide ion migration and the amount of excess oxygen decreased with increasing Ca content. These lead to the high ionic conductivity. In case of electronic conductivity, it increased with Ca-doping level by charge compensation of the oxidation of Ni^{2+} to Ni^{3+} .



Ding et al. [30] investigated the thermal expansion and electrochemical performance of $\text{La}_{0.7}\text{AE}_{0.3}\text{CuO}_3$ (AE=Ca, Sr, Ba). It was found that Ca-containing composition had the highest electrical conductivity and the lowest thermal expansion coefficient (TEC). Moreover, the electrochemical activity was also enhanced.

Chen et al. [31] reported that the oxygen permeation flux of $\text{Ba}_{0.4}\text{Co}_{0.4}\text{Fe}_{0.4}\text{Zn}_{0.2}\text{O}_3$ did not decrease during the experimental operation of 100 hours. The reason was doping with zinc, which had a constant oxidation state of +2, avoided the reduction of $\text{Co}^{3+}/\text{Co}^{2+}$ or $\text{Fe}^{3+}/\text{Fe}^{2+}$.

Park et al. [32] studied the electrochemical behavior of $\text{Ba}_{0.5}\text{Sr}_{0.5}\text{Co}_{0.2-x}\text{Zn}_x\text{Fe}_{0.8}\text{O}_3$. They found that substitution with zinc improved the thermal stability and minimized the Co^{4+} loss in the structure. These resulted in the decrease of R_p value and high performance.

Kostoglou et al. [33] examined the oxygen nonstoichiometry of $\text{Pr}_{1-x}\text{Sr}_x\text{Co}_{0.2}\text{B}_{0.8}\text{O}_3$ (PSC, B= Mn, Fe) by thermogravimetric analyses. They found that the loss of lattice oxygen in Fe-doped PSC was easily created, indicating the resistivity of the oxidation of Fe from Fe^{3+} to Fe^{4+} . Moreover, the magnitude of oxygen loss also increased with increasing the Sr content.

Petitjean et al. [34] investigated the oxygen transport properties of $(\text{La}_{0.8}\text{Sr}_{0.2})(\text{Mn}_{1-y}\text{Fe}_y)\text{O}_3$. They found that the oxygen diffusion via oxygen vacancy was enhanced by iron substitution because of the increase in oxygen vacancy concentration. On the other hand, the electronic conductivity was decreased resulting from the decrease in the concentration of available hopping site which limited the electrical conduction.

Miyoshi et al. [35] studied on Fe-doped $\text{Pr}_2\text{Ni}_{0.8}\text{Cu}_{0.2}\text{O}_4$ for oxygen-permeating membranes. They found that replacing Ni with Fe led to the increase in excess amount of oxygen, resulting in the enhancement of oxygen permeation rate, especially at low temperature. The highest oxygen permeation rate was achieved for $\text{Pr}_2\text{Ni}_{0.75}\text{Cu}_{0.2}\text{Fe}_{0.05}\text{O}_4$.

From the literatures, the substitution of Ca, Fe and Zn ions can promote the conducting properties of perovskite oxides. Therefore the purpose of this work is to improve such properties of $\text{La}_{1.6}\text{Sr}_{0.4}\text{NiO}_4$ (LSN), $\text{La}_{1.6}\text{Sr}_{0.4}\text{Ni}_{0.9}\text{Co}_{0.1}\text{O}_4$ (LSNC) and $\text{La}_2\text{Ni}_{0.9}\text{Co}_{0.1}\text{O}_4$ (LNC) including electrical conductivity and oxygen permeation by substitution of Ca, Fe and Zn ions, for an alternative cathode material in IT-SOFCs.



1.8 The objectives of this thesis

- 1.3.1 To synthesize K_2NiF_4 -type cathode materials substituted with Ca, Fe and Zn as below:
- $(La_{0.8}Sr_{0.2})_{2-x}Ca_xNiO_4$ (LSN- Ca_x , $x=0-0.5$)
 - $(La_{0.8}Sr_{0.2})_{2-x}Ca_xNi_{0.9}Co_{0.1}O_4$ (LSN- Ca_x , $x=0-0.5$)
 - $La_{2-x}Ca_xNi_{0.9-y}Co_{0.1}(Fe,Zn)_yO_4$ (LNCf- Ca_x and LNCZ- Ca_x , $y=0-0.2$, $x=0-0.7$)
- 1.3.2 To characterize the prepared compounds for phase structure, surface morphology and conducting property.
- 1.3.3 To measure the electrochemical performance of the selected compounds which perform good electrical conductivity by single cell test.

