

Occupational hazard identification and health risk assessment of  
volatile organic compounds exposure in plastic recycling plants  
in Thailand: Case studies of polypropylene and polyethylene

Mr. Muhammed Ayaj Ansar

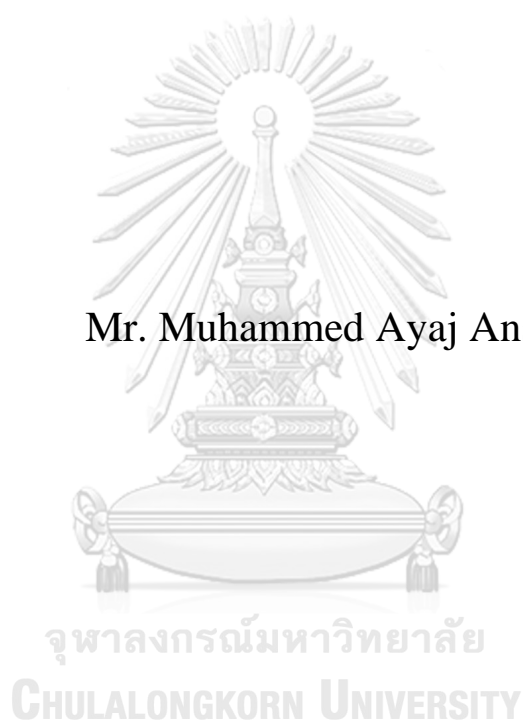

A Thesis Submitted in Partial Fulfillment of the Requirements  
for the Degree of Master of Science in Hazardous Substance and  
Environmental Management  
Inter-Department of Environmental Management  
GRADUATE SCHOOL  
Chulalongkorn University  
Academic Year 2019  
Copyright of Chulalongkorn University

การประเมินความเสี่ยงด้านอาชีวอนามัยและความเสี่ยงต่อสุขภาพจากการรับสัมผัสสารอินทรีย์  
ระเหยง่ายจากกระบวนการรีไซเคิลขยะพลาสติกชนิด โพลีเอธิลีนและโพลีโพรพิลีนในประเทศไทย



วิทยานิพนธ์นี้เป็นส่วนหนึ่งของการศึกษาตามหลักสูตรปริญญาวิทยาศาสตรมหาบัณฑิต  
สาขาวิชาการจัดการสารอันตรายและสิ่งแวดล้อม สหสาขาวิชาการจัดการสิ่งแวดล้อม

บัณฑิตวิทยาลัย จุฬาลงกรณ์มหาวิทยาลัย

ปีการศึกษา 2562

ลิขสิทธิ์ของจุฬาลงกรณ์มหาวิทยาลัย

Thesis Title	Occupational hazard identification and health risk assessment of volatile organic compounds exposure in plastic recycling plants in Thailand: Case studies of polypropylene and polyethylene
By	Mr. Muhammed Ayaj Ansar
Field of Study	Hazardous Substance and Environmental Management
Thesis Advisor	Assistant Professor Suthirat Kittipongvises, Ph.D.
Thesis Co Advisor	Pummarin Khamdahsag, Ph.D.

---

Accepted by the GRADUATE SCHOOL, Chulalongkorn University in  
Partial Fulfillment of the Requirement for the Master of Science

..... Dean of the GRADUATE  
SCHOOL  
(Assistant Professor THUMNOON NHUJAK, Ph.D.)

THESIS COMMITTEE

..... Chairman  
(Associate Professor EKAWAN LUEPROMCHAI,  
Ph.D.)

..... Thesis Advisor  
(Assistant Professor Suthirat Kittipongvises, Ph.D.)

..... Thesis Co-Advisor  
(Pummarin Khamdahsag, Ph.D.)

..... Examiner  
(Assistant Professor PENRADEE CHANPIWAT, Ph.D.)

..... External Examiner  
(Associate Professor Laksana Laokiat, Ph.D.)

จุฬาลงกรณ์มหาวิทยาลัย  
CHULALONGKORN UNIVERSITY

มูฮัมหมัด อายาจ อันซาร์ : การประเมินความเสี่ยงด้านอาชีวอนามัยและความเสี่ยงต่อสุขภาพจากการรับสัมผัสสารอินทรีย์ระเหยง่ายจากกระบวนการรีไซเคิลขยะพลาสติกชนิดโพลีเอทิลีนและโพลีโพรพิลีนในประเทศไทย. (Occupational hazard identification and health risk assessment of volatile organic compounds exposure in plastic recycling plants in Thailand: Case studies of polypropylene and polyethylene) อ.ที่ปรึกษาหลัก : ผศ. ดร.สุทธิรัตน์ กิตติพงษ์วิเศษ, อ.ที่ปรึกษาร่วม : ดร.กมลรินทร์ คำเดชศักดิ์

การรีไซเคิลขยะพลาสติกของสถานประกอบการขนาดเล็กอาจพบสิ่งคุกคามในสภาพแวดล้อมการทำงานและก่อให้เกิดความเสี่ยงด้านอาชีวอนามัยด้านต่างๆ อย่างหลีกเลี่ยงไม่ได้ วัตถุประสงค์ของการศึกษาค้นคว้าครั้งนี้ ได้แก่ การระบุและประเมินความเสี่ยงต่อสุขภาพในกระบวนการรีไซเคิลขยะพลาสติก โดยเฉพาะการรับสัมผัสสารอินทรีย์ระเหยง่ายและเสนอแนะแนวทางการควบคุมความเสี่ยงและยกระดับความปลอดภัยในสถานที่ปฏิบัติงาน ผลการศึกษา พบว่า ความร้อน เสียง และ ไอระเหยสารประกอบอินทรีย์ระเหยง่ายจัดเป็นประเภทสิ่งคุกคามที่สำคัญและก่อให้เกิดความเสี่ยงสูงในกระบวนการรีไซเคิลขยะพลาสติกของสถานประกอบการขนาดเล็ก ทั้งนี้ ผลการประเมินสภาวะการทำงานเกี่ยวกับความร้อนพบว่าระดับความร้อนในพื้นที่ปฏิบัติงานหลายสถานประกอบการพบค่าสูงเกินค่ามาตรฐานตามลักษณะของ “งานหนัก” ที่ระบุไว้ในกฎกระทรวงแรงงาน ซึ่งไม่ควรเกินอุณหภูมิเวดบัลด์โกลบ 30 องศาเซลเซียส โดยค่าความร้อนที่ตรวจพบแตกต่างกันขึ้นอยู่กับชนิดขยะพลาสติกและลักษณะโรงงานอย่างมีนัยสำคัญทางสถิติ ( $p < 0.05$ ) ขณะเดียวกัน ผลการตรวจวัดไอระเหยสารประกอบอินทรีย์ระเหยง่ายในกระบวนการรีไซเคิลขยะพลาสติกชนิดโพลีเอทิลีนและโพลีโพรพิลีน พบเฉพาะเฮกเซนและโทลูอีนในพื้นที่การผลิตของสถานประกอบการกรณีศึกษา ซึ่งมีความเข้มข้นระหว่าง 627 – 1,175 ไมโครกรัมต่อลูกบาศก์เมตร และ 292 – 451 ไมโครกรัมต่อลูกบาศก์เมตร ตามลำดับ โดยตรวจพบความเข้มข้นของสารประกอบอินทรีย์ระเหยง่ายในกระบวนการหลอมพลาสติกชนิดโพลีโพรพิลีนสูงกว่าโพลีเอทิลีน ขณะเดียวกัน ผลการประเมินความเสี่ยงต่อสุขภาพชนิดไม่ก่อให้เกิดโรคมะเร็งจากการรับสัมผัสไอระเหยของสารเฮกเซนและ โทลูอีนในกระบวนการหลอมขยะพลาสติกทั้งในกระบวนการรีไซเคิลขยะพลาสติกชนิดโพลีเอทิลีนและโพลีโพรพิลีน พิจารณาทั้งค่าสัดส่วนความเสี่ยงอันตราย (Hazard Quotient: HQ) และ ดัชนีบ่งชี้อันตราย (Hazard Index: HI) มีค่าน้อยกว่า 1 แสดงว่าการรับสัมผัสสารดังกล่าวยังไม่มีความเสี่ยงต่อสุขภาพ อย่างไรก็ดี ในสถานการณ์ที่สถานประกอบการมีการหลอมพลาสติกชนิดโพลีโพรพิลีนเพียงชนิดเดียวอาจส่งผลให้ค่า HQ และ HI มีค่ามากกว่า 1 หรือเกิดความเสี่ยงต่อสุขภาพจากการรับสัมผัสไอระเหยจากทั้งสารเฮกเซนและโทลูอีนจากกระบวนการผลิต ผลการศึกษาวินิจฉัยครั้งนี้เสนอแนะให้มีการจัดการและควบคุมความเสี่ยงเพื่อนำไปสู่ความปลอดภัยของผู้ปฏิบัติงาน โดยเฉพาะกลุ่มที่ต้องรับสัมผัสไอระเหยสารประกอบอินทรีย์ระเหยง่ายและความร้อนในกระบวนการหลอมขยะพลาสติกอย่างเหมาะสมต่อไป

สาขาวิชา	การจัดการสารอันตรายและสิ่งแวดล้อม	ลายมือชื่อนิสิต .....
ปีการศึกษา	2562	ลายมือชื่อ อ.ที่ปรึกษาหลัก .....
		ลายมือชื่อ อ.ที่ปรึกษาร่วม .....

# # 6187543620 : MAJOR HAZARDOUS SUBSTANCE AND ENVIRONMENTAL MANAGEMENT

KEYWORD Plastic waste recycling, Polypropylene, Polyethylene, Volatile organic compounds, Health risk assessment, Hazard identification

D: Muhammed Ayaj Ansar : Occupational hazard identification and health risk assessment of volatile organic compounds exposure in plastic recycling plants in Thailand: Case studies of polypropylene and polyethylene. Advisor: Asst. Prof. Suthirat Kittipongvises, Ph.D. Co-advisor: Pummarin Khamdahsag, Ph.D.

Mechanical recycling in small scale plastic recycling plants in Thailand with mechanical and thermal driven stages may lead to various occupational hazards. This study aimed to improve occupational safety and health (OSH) by reducing these risks to acceptable levels from hazard identification and risk assessments which were mainly associated with indoor volatile organic compounds (VOCs) exposure. Accordingly, heat, noise, and VOCs were identified as potential hazards in the hazard identification from four selected small-scale plastic recycling plants in Thailand with polypropylene (PP) and polyethylene (PE) recycling practices. In exposure assessment, almost all the exposure levels of heat stress exceeded the Thai OSH regulation limit of 30°C for heavy workers, which was not acceptable according to the risk evaluation in the preliminary study. Also, these values showed a significant difference ( $p < 0.05$ ) among the recycling plants and recycling practices. In VOC analysis, only hexane and toluene were detected in the indoor air at concentrations ranged from 627  $\mu\text{g}/\text{m}^3$ -1175  $\mu\text{g}/\text{m}^3$  and 292  $\mu\text{g}/\text{m}^3$ -451  $\mu\text{g}/\text{m}^3$  respectively. Here, high concentrations of hexane and toluene were detected at PP extrusion compared to PE. Hence, the non-cancer hazard quotients (HQs) and hazard indices (HIs) for exposed workers were high in PP comparative to PE, although all HIs and HQs were below 1.0 for all recycling practices. Still, there is a probability for non-cancer risk likely to affect the workers only from hexane at all recycling practices as related HIs and HQs values exceed 0.1. However, in the comparison scenario, the non-cancer risk could be expected as the estimated HQs and HIs were above 1.0 for hexane and toluene, if a particular plant may only recycle PP without PE. In conclusion, workers assigned at the processing line from extrusion to pelletizing (especially extruder) were the group of workers at higher risk from VOCs and heat. The implementation of relevant safety measures was highly recommended to minimize these identified risks.

Field of Study:	Hazardous Substance and Environmental Management	Student's Signature .....
Academic Year:	2019	Advisor's Signature .....
		Co-advisor's Signature .....

## ACKNOWLEDGEMENTS

Foremost, I would like to express my sincere gratitude to my advisor, Asst. Prof. Suthirat Kittipongvises for her immense support and guidance throughout these two years of my master's degree which led to a successful master's thesis. Also, I am grateful for my co adviser, Dr. Pummarin Khamdahsag and my committee members Assoc. Prof. Ekawan Luepromchai, Asst. Prof. Penradee Chanpiwat, Assoc. Prof. Laksana Laokiat for their valuable comments and suggestion on this thesis.

Also, I would like to express my sincere gratitude to IP-HSM, Graduate School, Chulalongkorn University for providing 'full scholarship of H.M. the King Bhumibhol Adulyadej's 72nd Birthday Anniversary Scholarship and Scholarship for graduate students to support this study.

Muhammed Ayaj Ansar

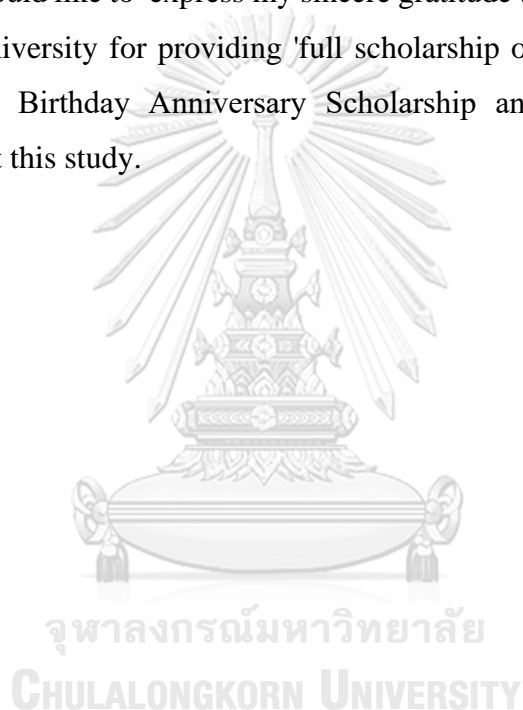

# TABLE OF CONTENTS

	<b>Page</b>
.....	iii
ABSTRACT (THAI) .....	iii
.....	iv
ABSTRACT (ENGLISH).....	iv
ACKNOWLEDGEMENTS.....	v
TABLE OF CONTENTS.....	vi
LIST OF TABLES.....	xi
LIST OF FIGURES .....	xiii
LIST OF ABBREVIATIONS.....	1
CHAPTER 1 INTRODUCTION.....	3
1.1. Background.....	3
1.2 Problem statement of this research.....	6
1.3 Objectives .....	7
1.4 Scope of the study.....	7
CHAPTER 2 LITERATURE REVIEW.....	9
2.1 Thermoplastic.....	9
2.1.1 Polypropylene.....	9
2.1.2 Polyethylene .....	9
2.2 Mechanical recycling: secondary recycling.....	10
2.2.1 Existing technologies applied in mechanical recycling plants.....	11
2.2.2 Extrusion and Pelletizing.....	12
2.3 Occupational safety and health (OSH) .....	13
2.3.1 OSH regulatory framework in Thailand.....	13
2.3.2 Occupational safety and health program in Thailand.....	13
2.4 OSH conditions in relation to Heat, Noise and Light.....	14

2.4.1 Heat .....	14
2.4.2 Noise.....	15
2.4.3 Light .....	15
2.5 Hazard identification and risk assessment for SSEs.....	16
2.5.1 Hazard identification .....	17
2.5.2 Occupational hazard identification and risk assessment in PSW recycling facilities .....	18
2.6 VOCs emission from the melting process of plastics .....	18
2.6.1 Emissions from PSW recycling plants: the case of PP and PE.....	18
2.6.2 VOC species emitted in PP and PE melting.....	20
2.6.3 Indoor sampling in previous studies.....	21
2.7 Human health effects: Inhalation exposure .....	21
2.7.1 Non-Carcinogenic Effect.....	22
2.7.2 Carcinogenic Effect.....	22
2.8 HRA: PSW recycling plants .....	23
2.8.1 Occupational exposure limits .....	23
2.8.2 Non-cancer risk .....	24
2.8.3 Cancer risk.....	24
CHAPTER 3 RESEARCH METHODOLOGY .....	25
3.1 Case studies .....	25
3.2 Site survey and preliminary study .....	27
3.2.1 Hazard Identification .....	27
3.2.2 Exposure Assessment .....	28
3.2.2.1 Heat stress.....	28
Environmental parameters measurement.....	28
Heat stress measurement.....	29
3.2.2.2 Noise level .....	31
3.2.2.3 Light .....	32
3.2.3 Risk evaluation and estimation.....	34



3.2.3.1 Risk matrix method .....	34
3.2.4 OSH data interpretation .....	35
3.3 Indoor quantitative VOC analysis .....	36
3.3.1 Air Sampling and analytical method .....	36
3.3.1.1 Sampling at sites .....	36
3.3.1.2 Extraction of samples .....	39
3.3.1.3 Quantitative analysis .....	40
3.3.1.4 VOC emission profile and analysis .....	41
3.4 Human health risk assessment of indoor VOC exposure .....	41
3.4.1 Calculation of mean concentration of VOCs exposed to workers .....	41
3.4.2 Estimate risk characterization criteria .....	42
3.4.3 Occupational exposure limits (OEL) for workers .....	43
3.4.4 Cancer risk for workers .....	44
3.4.5 Non-cancer risk for workers .....	45
3.4.5.1 Hazard quotient .....	45
3.4.5.2 Hazard Index .....	45
3.4.6 Cumulative estimate risk characterization .....	46
3.4.7 Assumptions and limitations for HRA .....	46
CHAPTER 4 RESULTS AND DISCUSSION .....	48
4.1 Site survey .....	48
4.1.1 Plant A .....	48
4.1.1.1 Production process .....	48
4.1.1.2 Description of infrastructure facilities and working environment .....	49
4.1.1.3 Resource consumption .....	51
4.1.2 Plant B .....	51
4.1.2.1 Production process .....	52
4.1.2.2 Description of infrastructure facilities and working environment .....	53
4.1.2.3 Resource consumption .....	55
4.1.3 Plant C .....	55

4.1.3.1 Production process .....	55
4.1.3.2 Description of infrastructure facilities and working environment	56
4.1.4 Plant D .....	58
4.1.4.1 Production process .....	58
4.1.4.2 Description of infrastructure facilities and working environment	59
4.2 Preliminary Study .....	61
4.2.1 Hazard identification .....	61
4.2.2 Exposure Assessment .....	64
4.2.2.1 Heat stress.....	64
Environmental Parameters.....	64
Heat stress index .....	65
4.2.2.2 Noise level .....	69
4.2.2.3 Illuminance (light) .....	70
4.2.2.4 Volatile Organic Compounds (VOC's) .....	71
4.2.3 Risk Evaluation and Estimation.....	72
4.2.3.1 Risk matrix method .....	72
4.3 VOC emissions from PSW extrusion process .....	75
4.3.1 Initial step in quantitative analysis of VOC analysis .....	75
4.3.2 Quantitative analysis of toluene and hexane .....	76
4.4 Occupational health risk assessment of VOC exposure .....	80
4.4.1 Occupational exposure limits .....	80
4.4.2 Non-cancer risk .....	81
4.4.2.1 Hazard quotient (HQ).....	81
4.4.2.2 Hazard Index (HI).....	84
4.4.3 Cancer Risk .....	87
4.4.4 Uncertainty analysis .....	88
4.5 The possible factors that affect the overall outcome of the study .....	89
4.6 Recommendations: Possible safety measures for risk management.....	91
4.6.1 Heat hazard.....	91

4.6.1.1 Engineering controls.....	92
4.6.1.2 Administrative controls .....	93
4.6.2 Chemical hazards (VOC) .....	94
4.6.2.1 Engineering controls.....	94
4.6.3 Noise hazard (only for future reference) .....	95
4.6.3.1 Engineering controls.....	96
CHAPTER 5 CONCLUSIONS .....	99
REFERENCES .....	104
Appendix A.....	111
Appendix B .....	112
Appendix C .....	113
VITA.....	114

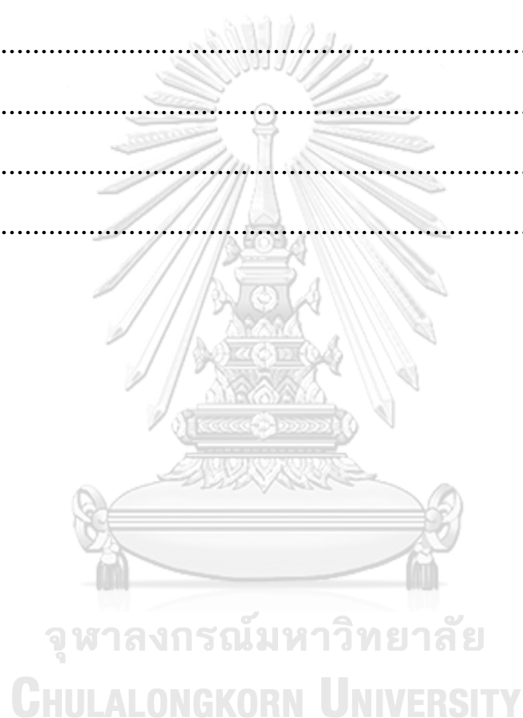

## LIST OF TABLES

	<b>Page</b>
Table 2.1 Major VOC compounds emitted at PP and PE recycling plants (He et al., 2015) .....	20
Table 2.2 Sampling and analytical procedures for the determination of VOCs in air .21	
Table 2.3 IARC’s degree of evidence for cancer risk effects for chemical compounds .....	23
Table 3.1 Comparison of similarities and differences among selected plastic recycling plants .....	26
Table 3.2 Threshold limit values for occupational heat stress measurements (ACGIH) (Heat Stress and Strain: TLV® Physical Agents 7th Edition Documentation 2017) ..31	
Table 3.3 Action limit values for occupational heat stress measurements (ACGIH) (Heat Stress and Strain: TLV® Physical Agents 7th Edition Documentation 2017) ..31	
Table 3.4 Probability levels for risk evaluation and estimation ("Regulation of Department of Industrial Works. Re: Criteria for hazard identification, risk assessment, and establishment of risk management plan B.E. 2543 ", 2000) .....	34
Table 3.5 Severity levels for risk evaluation and estimation (Ramesh et al., 2017)....35	
Table 3.6 Sampling plan for each recycling plant .....	36
<i>Table 3.7 Recycling practices conducted at each recycling plant on sampling days ..37</i>	
Table 3.8 NIOSH standard methods for air sampling and analysis of VOCs.....38	
Table 3.9 GC-FID condition for NIOSH 1500 and 1501 methods.....40	
Table 3.10 GC-FID condition for NIOSH 2541 method .....	41
Table 4.1 Environmental parameters and heat stress index of recycling plants .....	65
Table 4.2 Screening of calculated & measured WBGT values (oC) with ACGIH standards .....	67
Table 4.3 Determined severity and probability levels for the identified hazards .....	73
Table 4.4 Evaluated risk levels for all identified hazards in plastic recycling plants ..74	
Table 4.5 Risk level guideline ("Regulation of Department of Industrial Works. Re: Criteria for hazard identification, risk assessment, and establishment of risk management plan B.E. 2543 ", 2000) .....	74

Table 4.6 Indoor air concentrations of selected volatile organic compounds.....76



## LIST OF FIGURES

	<b>Page</b>
Figure 2.1 Molecular structure of PP.....	9
Figure 2.2 Molecular structure of PE.....	10
Figure 2.3 Complete recycling scheme of mechanical recycling plant (sorting (1); shredding (2); washing with or without cleaning agents (3); drying (4); mixing silos (5); agglutination (product with fine thickness); (6) Extrusion (7); pelletizing (8))....	12
Figure 2.4 Schematic overview of extrusion and pelletizing (National Study Plastic Recycling Sector, 2008).....	12
Figure 2.5 Risk matrix of the shredding system in a plastic recycling plant (Cioca et al., 2018) .....	18
Figure 2.6 Percentage contribution of groups of VOCs emitted in different PSW recycling workshops during extrusion processes (He et al., 2015).....	19
Figure 3.1 Overall framework of this research .....	25
Figure 3.2 Scope of the study .....	26
Figure 3.3 The generalized layout to represent all recycling plant for WBGT inspection points for heat stress exposure assessment.....	30
Figure 3.4 The WBGT inspection point at the extrusion process (abdominal level) in one of a recycling plant.....	30
Figure 3.5 The generalized layout to represent all recycling plant for Noise level inspection points for noise survey.....	32
Figure 3.6 Light measurement of a room with a single middle light (Assessment of light from work).....	33
Figure 3.7 Light measurement of a Single Row of Individual Luminaires (Assessment of light from work).....	33
Figure 3.8 Sampling procedure for indoor quantitative VOC analysis of plastic recycling plants .....	37
Figure 3.9 Placement of the sampling apparatus for VOC concentrations at breathing zone of workers at extruder machine .....	39
Figure 3.10 Extraction procedure of indoor quantitative VOC analysis of plastic recycling plants .....	40

Figure 3.11 Real-time scenario for quantitative health risk characterization of VOCs emitted from plastic recycling plants .....	43
Figure 4.1 Process flow diagram of plastic recycling plant A .....	49
Figure 4.2 Infrastructure facilities and working conditions of the Main workstation in plastic recycling plant A .....	50
Figure 4.3 Schematic layout of the plastic recycling plant A .....	50
Figure 4.4 Process flow diagram of plastic recycling plant B .....	52
Figure 4.5 Schematic layout of the plastic recycling plant B .....	53
Figure 4.6 Infrastructure facilities and working conditions of the Main workstation in plastic recycling plant B.....	54
Figure 4.7 Process flow diagram of Plant C .....	56
Figure 4.8 Infrastructure facilities and working conditions of the Main workstation in plastic recycling plant C.....	57
Figure 4.9 Schematic layout of the plastic recycling plant C .....	57
Figure 4.10 Schematic layout of the plastic recycling plant D .....	60
Figure 4.11 Infrastructure facilities and working conditions of the Main workstation in plastic recycling plant C.....	60
Figure 4.12 Several areas and process inspected under the hazard identification: (A) Extrusion; (B) Shredding; (C) VOCs emission from extruders; (D) Warehouse .....	62
Figure 4.13 Heat stress values ( $^{\circ}\text{C}$ ) at extrusion and MWS of plastic recycling plants .....	66
Figure 4.14 Noise levels at different stages of plastic recycling plant .....	69
Figure 4.15 Illuminance at different stages of plastic recycling plant.....	71
Figure 4.16 Mean concentration of hexane, toluene, and TVOCs exposed to workers within 8h working shift in PP and PE recycling practices during extrusion processes of plastic recycling plants .....	78
Figure 4.17 The occupational exposure indexes ( $E_i$ ) assessment of hexane, toluene, and TVOCs exposed to workers in PP and PE recycling practices (Real-time scenario) during extrusion processes of plastic recycling plants.....	80
Figure 4.18 Non-cancer hazard quotients of hexane and toluene exposed to workers in PP and PE recycling practices (Real-time scenario) during extrusion processes of plastic recycling plants.....	82

Figure 4.19 Non-cancer hazard quotients of hexane and toluene exposed to workers in PP and PE recycling practices (comparison scenario) during extrusion processes of plastic recycling plants.....	83
Figure 4.20 Estimated non-cancer hazard index of hexane and toluene separately that exposed to workers in PP and PE recycling practices (real-time situation) during extrusion processes of plastic recycling plants .....	85
Figure 4.21 Non-cancer hazard index from both hexane and toluene exposed to workers in PP and PE recycling practices (real-time situation) during extrusion processes of plastic recycling plants .....	86
Figure 4.22 Non-cancer hazard index from both hexane and toluene exposed to workers in PP and PE recycling practices (comparison scenario) during extrusion processes of plastic recycling plants .....	87
Figure 4.23 Schematic diagram of an extruder with the installation of heat insulation cover (or blanket).....	92
Figure 4.24 Schematic diagram of an extruder for appropriate placement of the fume extraction system's inlets.....	95
Figure 4.25 Schematic diagram of a shredder .....	96
Figure 4.26 Schematic diagram of an extruder.....	97
Figure 4.27 Schematic diagram of a pelletizer .....	98



## LIST OF ABBREVIATIONS

ACGIH	American Conference of Industrial Hygienists
AL	Action Limit
ASHRAE	American Society of Heating, Refrigerating and Air-Conditioning Engineers
BHT	Butylated hydroxytoluene
CAF	Cloth adjustment factor
CDI	Chronic daily intake
HDPE	High-Density Polyethylene
HI	Hazard Index
HRA	Health Risk Assessments
HQ	Hazard quotient
IARC	International Agency for Research on Cancer
ILO	International Labour Organization
IR	Inhalation rate
IRIS	Integrated Risk Information System
LCA	Life cycle assessment
LCIA	Life cycle impact assessment
LCR	Lifetime cancer risk
LDPE	Low-Density Polyethylene
LOD	Limit of detection
MPW	Mismanaged Plastic Waste
MWS	Main workstation
NIOSH	National institute occupational safety and health
NOAA	National Oceanic and Atmospheric Administration
NWS	National Weather Service
OEL	Occupational exposure limits
OHSMS	Occupational health and safety management system
OSH	Occupational Safety and Health
OSHA	Occupational safety and health administration
PAE	Phthalate Esters

PAHs	Polycyclic Aromatic Hydrocarbons
PE	Polyethylene
PET	Polyethylene terephthalate
PP	Polypropylene
PS	Polystyrene
PSW	Plastic Solid Waste
PVC	Polyvinyl chloride
QRA	Quantitative Risk Assessment
RfD	Reference dose
RfC	Reference concentration
RH	Relative humidity
RSD	Relative Standard Deviation
SB	Sorbent Enrichment
SE	Solvent Extraction
SF	Slope factor
SSE	Small Scale Enterprises
TLV	Threshold Limit Value
TVOCs	Total VOCs
TWA	Time-weighted average
USEPA	United states Environmental protection agency
VOC	Volatile Organic Compounds
WBGT	Wet Bulb Globe Temperature

# CHAPTER 1

## INTRODUCTION

### 1.1. Background

The exponential growth of global plastic and the associated plastic solid waste (PSW) has increased tremendously in recent decades, its economical price, flexibility to mold, and lightweight being a few of the advantages (Nkwachukwu, Chima, Ikenna, & Albert, 2013). In 2015, the world generated about 300 million metric tons (Mt) of PSW. From the PSW global situation, Lebreton and Andrady (2019) estimated the mismanaged plastic waste (MPW) generation in current waste disposal scenarios from 2015 to 2060. Accordingly, it was estimated that 80 Mt of municipal plastic waste was inadequately disposed into the environment during 2015. Also, Thailand was within the top ten ranks by generating 1.77 Mt of MPW in 2015. Dealing with these enormous MPW remains a challenging task in many countries including Thailand, and the concerns have increased due to their extremely persistent in the natural environment (Geyer, Jambeck, & Law, 2017). The discouragingly stagnant growth in recycling rates and the likely increase in single-use plastic products has impacted the situation negatively. However, several communities have started to realize the importance of the environment and understood the severity of the situation, including the harmful and pernicious effects on wildlife (Isangedighi, David, & Obot, 2018).

Plastic waste has elevated by 12% within Thailand over the last decade, commuting to 2 million tons every year (Wichai-utcha & Chavalparit, 2019). Out of all types of plastics, polyethylene (PE) and polypropylene (PP) contributed approximately 90% of total plastic waste in Thailand (Chira, Taweep, & Praj-Ya, 2018). Due to legislation constraints, high cost, and the poor biodegradability of commonly used petroleum-based plastics, the traditional way of landfilling has become an unacceptable way of disposal (Achilias, Roupakias, Megalokonomos, Lappas, & Antonakou, 2007). As an alternative, incineration has been criticized for generating large amounts of bottom ash and various toxic air pollutants like polycyclic aromatic hydrocarbons (PAHs) (Vejerano, Holder, & Marr, 2013). Therefore, the focus has to be in the recycling of these waste streams with a view to closing loops and grow further into a

'circular economy' way of thinking (Moraga et al., 2019). The recycling, either mechanical or chemical generates secondary raw materials that can be used for their original or other purposes. Hence, the PSW recycling approach is a highly advisable method for resource and energy conservation and waste gas emission reduction (Ignatyev, Thielemans, & Vander Beke, 2014). In that case, plastic waste recyclers play an important role in that plastic waste management network in Thailand. In 2013, the amount of PSW that was recycled by manufacturers in Thailand was approximately 0.77 Mt or 22% of post consumed waste and 0.8 Mt of recyclable PSW from industries (10% from entire production) (Chira et al., 2018).

Out of different types of recycling, the mechanical recycling approach is the commonly practiced recycling approach in small scale recycling plants in Thailand. In the process of mechanical recycling, raw materials subjected to mechanical processes (shredding, pelletizing) and thermal processes (melting/extrusion) to produce pellets as the final product which is used as raw material for plastic manufacturing industries (Al-Salem, Lettieri, & Baeyens, 2009). However, these mechanically and thermally driven stages may lead to various occupational hazards including physical, chemical, etc. (Sari, Syahputri, Rizkya, & Siregar, 2017). Furthermore, Small Scale Enterprises (SSEs) have a more inadequate safety record than large enterprises where the rate of fatal and severe injuries in SSEs (than 50 employees) is double than in larger workshops (more than 200 employees) (Alli, 2008). Compared to large enterprises, the most distinguishable and crucial differences in SSEs such as economic instability without sufficient management conditions and less preparation with minimal assets. Therefore, the ability for working environment improvements is highly present and recommended (Park et al., 2013).

On the other hand, occupational safety and health legislation in most countries including Thailand have exempted SSEs. Hence, most Thai workers belong to the informal economy are exposed to working conditions that are mostly outside regulation (Kelly et al., 2010). Also, according to the chapter 2: clause 23 of current Thai ministerial regulations for occupational safety and health (OSH), businesses that operate with less than 50 employees are not obligated to perform health management or hire a health manager ("Ministerial regulation on the prescribing of standard for administration and management of occupational safety, health and environment ",

2006). Therefore, most small scale PSW recycling plants in Thailand are not implementing any proper OSH management systems (OHSMS) (Phan & Santiponwut, 2004). Under these conditions, it may create a pathway to high-risk situations in the working environment. On this basis, every industry must identify hazards, assess associated risks, and minimize those risks to acceptable levels continued to improve OSH (Cioca et al., 2018).

The process of defining and describing hazards by characterizing their probability of recurrence, the severity of unfavorable consequences including potential losses and injuries can be defined as hazard identification and risk assessment (Suhardi, Laksono, Ayu, Mohd.Rohani, & Ching, 2018). This risk evaluation has been performed using guidelines and standards given by local authorities (L.-J. Zhou, Cao, Yu, Wang, & Wang, 2018). Moreover, occupational hazard identification and risk evaluation is a systematic approach of identifying and analyzing the potential hazards associated with an activity and assigning a level of risk for each hazard as an initial implementation of OSHMS for SSE (Organization, 2011). Often the objective of this type of risk assessment is used to manage priority risks, therefore, a systematic approach is required for an effective outcome than a quantitative approach. Also, occupational hazard identification was carried out to prioritize risks for further application of quantitative risk assessment (QRA) such as health risk assessments (HRA) of chemical hazards (Utembe, Faustman, Matatiele, & Gulumian, 2015).

In the field of HRA, scholars from across the globe have implemented this assessment for many sectors of production over the last two decades. However, only a few studies were reported on the HRA of PSW recycling plants by considering the volatile organic compounds (VOCs) emission at the extrusion process (He et al., 2015). Moreover, the health risk assessment in the PSW recycling sector has not yet become a routine task, and only VOC emission levels were focused on most studies (Huang, Zhou, Hong, Feng, & Tao, 2013). In the mechanical recycling steps, plastic waste is melted and thermally degrade at an above melting temperature only within the melting/extrusion machine which leads to the release various toxic gases including alkanes, alkenes, as well as chlorinated and aromatic hydrocarbons specifically for PP and PE plastics (Patel & Xanthos, 1995). Furthermore, in the case of many developing

countries due to primitive and basic facilities utilized for the extrusion process in most PSW recycling plants preceded to discharge of VOCs are directly into the outside environment without any forced ventilation or adequate treatment (He et al., 2015). Therefore, these VOCs consist of massive hazardous compounds posing health risks to workers and neighboring residents, and it was the main reason to focus the HRA on the exposure of VOCs emission (Colman Lerner, Sanchez, Sambeth, & Porta, 2012; Shan, Rahimnejad, Bahrami, & Farhadian, 2017). These human health effects of VOCs can be classified as either non-cancer or cancer risks (Rumchev, Brown, & Spickett, 2007). The main non-cancer chronic effects of VOCs are sensory, damages to the liver, kidneys, and central nervous system, asthma, and other respiratory effects. According to the WHO, the main cancer effects are lung, blood (leukemia and non-Hodgkin lymphoma), brain, liver, kidney, and biliary tract cancers (Ye et al., 2017). For instance, benzene can induce not only non-cancer risks of hepatotoxicity and aplastic anemia but also cancer risks of acute myelogenous leukemia and lymphoma (Sarma, Kim, & Ryu, 2011). Thus, it is necessary to assess the health effects on the workers exposed to VOCs.

## **1.2 Problem statement of this research**

PSW generation is one of the main issues we face today due to the increase in plastic consumption and the non-degradability of plastic. Different methods are used to manage this waste. Hence, the PSW recycling approach is a highly advisable method for resource and energy conservation and waste gas emission reduction, plastic waste recyclers who recycled at a small-scale level play an important role in the plastic waste management network in Thailand. The mechanical recycling approach is the commonly practiced recycling approach in these small-scale recycling plants in Thailand. However, this recycling process includes a series of mechanically and thermally driven stages that may lead to various occupational hazards including physical, chemical, etc. Regardless, most local small scale PSW recycling plants are not implementing good manufacturing practices and safety protocols due to the unavailability of proper OHSMS, which may lead to high-risk conditions within the working environment. Moreover, it was found that VOCs emitted from recycling plants cause an immense health risk. Therefore, it is especially important to understand and define all occupational health impacts of the plastic recycling practice by primarily focusing on

VOC exposure based on previous findings. Moreover, due to the current working conditions of SSEs in Thailand, the occupational risks due to physical agents like heat and noise might play a crucial role. Despite the above facts, there have been limited researches on the assessment of occupational health risks of plastic waste recycling in Thailand. In this research, the outcomes of human health risk evaluation were applied to formulate risk control and management procedure for small scale plastic recycling plants in Thailand.

### **1.3 Objectives**

The overall objective of this study was to evaluate the occupational health risks of plastic waste recycling in Thailand through occupational hazard identification and human health risk assessment by mainly concentrating on indoor VOC exposure. PP and PE recycling plants were selected as case studies. The following specific objectives were given:

1. To identify occupational hazards and evaluate the risk levels at plastic recycling plants in Thailand.
2. To analyze and characterize the emission of VOC's from PE and PP plastic recycling plants in Thailand.
3. To assess the human health risks of VOC exposure for workers at plastic recycling plants in Thailand using HRA.
4. To provide possible safety implementation recommendations to reduce risks from identified hazards in plastic recycling plants.

### **1.4 Scope of the study**

1. Four plastic waste recycling plants in Samutprakarn and Bangkok province were selected as case studies in this research. Those plants were producing plastic pellets using different plastic resins at 3 different recycling practices. i) PP plastic waste recycling process, ii) only PE plastic waste recycling process, and iii) combination between PP and PE plastic waste recycling process (i.e., processing lines of PP and PE are operated at the same time).

2. The preliminary study was conducted by employing occupational hazard identification and risk evaluation for plastic recycling plants. Prioritized the risk levels to perform further quantitative risk assessments.
3. HRA was carried out as a QRA to quantify the occupational health risk from VOCs exposure at different plastic waste recycling practices.





## CHAPTER 2

### LITERATURE REVIEW

#### 2.1 Thermoplastic

The structure of thermoplastic either linear or branched chain which responsible for its thermal behavior and strength. The melting point of thermoplastic is approximately 120°C – 180°C which changes its solid state into a liquid state (pasty). This type of plastic is very popular as it recyclable and easiness in large scale production. Most commonly generated forms of plastics are liquid or pellet since it has the ability to make various products. Both low-density polyethylene (LDPE) and high-density polyethylene (HDPE), Polystyrene (PS), and Poly-vinyl chloride (PVC) are some of the examples for Thermoplastics.

##### 2.1.1 Polypropylene

Polypropylene is an intense, inflexible, linear hydrocarbon resin and a crystalline thermoplastic made from propene (propylene) monomer. The chemical formula of polypropylene is  $(C_3H_6)_n$  (Figure 2.1) and it belongs to the polymer family of Polyolefin. PP is one of the cheapest plastics available present and it is in the top three among widely used polymers today (Maier & Calafut, 2008).

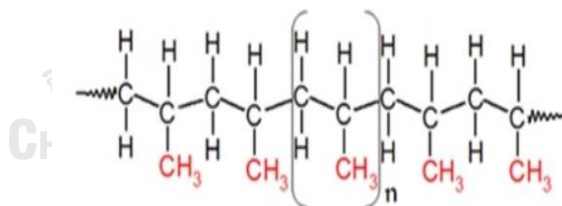

*Figure 2.1 Molecular structure of PP*

PP is a completely recyclable material and some of the products which can be made from recycled polypropylene (rPP) are automobile battery cases, brooms, ice scrapers, signal lights, brushes, etc. One of the major steps in PP recycling is the melting of plastic waste at 250°C temperature (Maier & Calafut, 2008).

##### 2.1.2 Polyethylene

Polythene is a widely manufactured plastic-type in the world that accounts for ten million tons per year. Polythene belongs to the thermoplastic category and it has a flexible crystalline structure with some other important characteristics such as

lightweight and durability. Polyethylene is made by its monomer; ethylene (ethene) polymerization. The chemical formula of Polythene is  $(C_2H_4)_n$  (Figure 2.2).

PE belongs to the polyolefin polymer and is categorized by its density and branching in its structure. LDPE and HDPE are the most common types of polyethylene (Whiteley, Heggs, Koch, Mawer, & Immel, 2000).

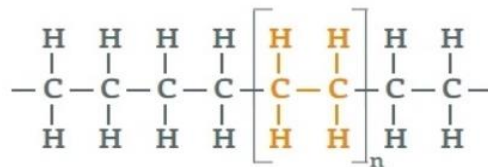

Figure 2.2 Molecular structure of PE

Since LDPE and HDPE are non-biodegradable, it has the highest contribution to the world's plastic waste. However, both LDPE and HDPE are recyclable, and it is used to produce plastics for outdoor applications, compost bins, bottles for non-food items, etc. Even though Polythene in a solid-state is non-toxic, Inhaling and/or absorbance of Polyethylene in vapor/liquid state could be toxic for humans (i.e. during manufacturing processes) (Whiteley et al., 2000).

## 2.2 Mechanical recycling: secondary recycling

Mechanical recycling was established and commercialized in the 1970s all over the world. It is the process of recovering plastic PSW for the re-use in manufacturing plastic products via mechanical means (Delva et al., 2019). It was promoted and commercialized all over the world back in the 1970s. Also, it is one of the pre-eminent technologies used in recycling plastics. In comparison with chemical, physicochemical, or energy recovery recycling, this type of recycling is the most environmentally friendly option (Al-Salem et al., 2009). However, from an economic perspective, it is not the most beneficial option. Plastic waste can be recycled in different ways based on types of polymers, product, and packaging design if the products consist of a single polymer or mixed polymers (Ragaert, 2016). Mechanical recycling of the PSW process can only be done on single-polymer plastic and it is one of the most common methods for recycling of thermoplastic polymers such as PP and PE (Veelaert, Du Bois, Hubo, Karen, & Ragaert, 2017). Several products found in our daily lives come from

mechanical recycling processes, such as grocery bags, pipes, gutters, window and door profiles, shutters, and blinds.

The quality is the main issue that needs to be considered when dealing with mechanically recycled products. In this type of recycling, the more complex and contaminated waste, the more difficult to recycle it mechanically. The separation, washing, and preparation of PSW can make high quality, clear, clean, and homogenous end-products. The industrial PSW generated during the manufacturing process of plastics can be used as a raw material for the mechanical recycling process due to the ability to distinguish the different resin types, lower impurity levels, and the available in large quantities.

### **2.2.1 Existing technologies applied in mechanical recycling plants**

Several treatments and preparation steps need to be considered when recycling PSW using a mechanical process. Mechanical recyclers always attempt to reduce the working hours and the steps of the treatment and preparation process to reduce the cost and energy generation. the costly and energy-intensive process. Usually, the manual sorting of PSW is the first step in the mechanical recycling process. The incoming PSW consists of mixed plastics that are likely contaminated by organic portions (such as food residues) and non-plastic inorganic portions (metals, wood, paper) (Elo, Karlsson, Lydebrant, & Sundin, 2009). In the first place, metals have to be removed from the waste stream, as these can damage the recycling plant's machinery. To obtain a good, recycled product, the plastic waste materials preferably have to be divided into colored and non-colored (transparent) fractions. At last, the different plastic types have to be sorted out. After sorting, PSW size is reduced to either powder or flakes by milling, grinding, or shredding (Zia, Bhatti, & Ahmad Bhatti, 2007). The general PSW recycling process is illustrated in Figure 2.3 (Al-Salem et al., 2009).

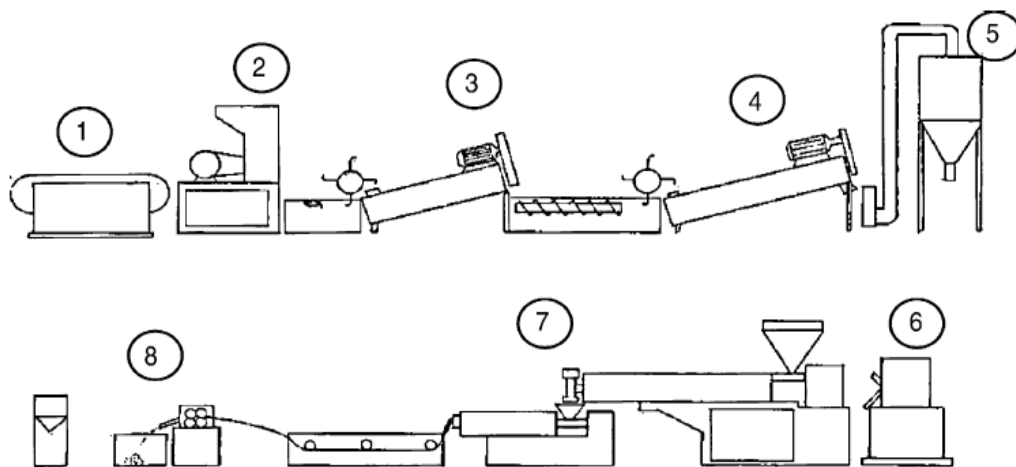

Figure 2.3 Complete recycling scheme of mechanical recycling plant (sorting (1); shredding (2); washing with or without cleaning agents (3); drying (4); mixing silos (5); agglutination (product with fine thickness); (6) Extrusion (7); pelletizing (8))

### 2.2.2 Extrusion and Pelletizing

To produce plastic pellets, shredded materials can be used directly for the pelletizing process. The extrusion machine is crucial in the production of plastic pellets in the pelletizing process. The main functions of the extrusion machine are the mixing of various substances/homogenization, compression, degassing, plasticization, and melt filtration. As the first step of pelletizing, it is required to feed the hopper of the extruder by plastic flakes and these flakes are going through a rotating screw. Figure 2.4 illustrates the overview of the extrusion and pelletizing processes.

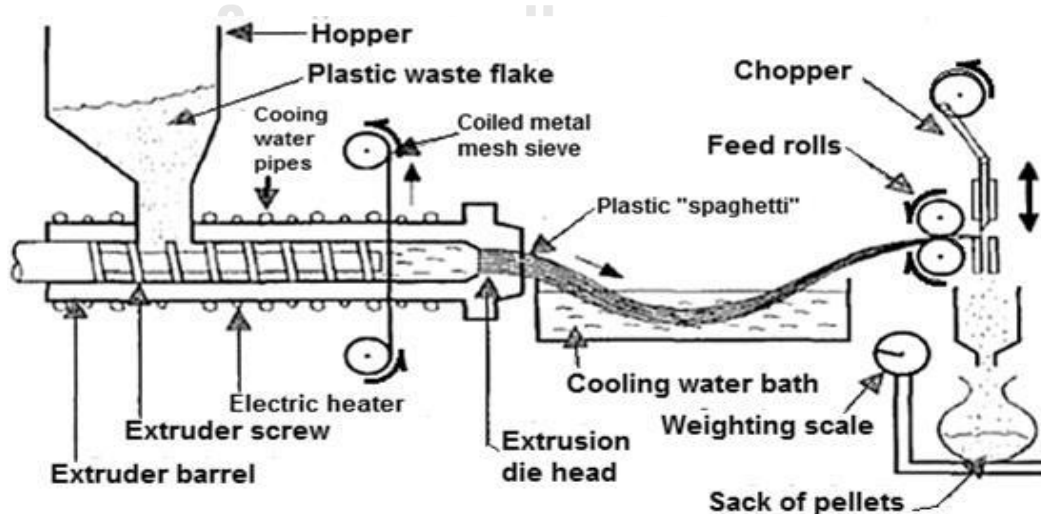

Figure 2.4 Schematic overview of extrusion and pelletizing (National Study Plastic Recycling Sector, 2008)

Then these flakes are pressed through a barrel into the extrusion die head. The temperature of the barrel is controlled by water heaters or air coolers around the barrel. The heat from friction along with the heat cremating from the heating elements causes plasticization (Ragaert, Delva, & Geem, 2017). The filter screen at the end of the die head removes residue wastes and solid particle which generated during the processing. The plastic strings coming out through the extrusion die head will be cooled by allowing these strings to pass through a water bath. The rollers at the end of the water basin support the strings which are strained to move into the pelletizer. At the end of this process, short, uniform, and cylindrical pellets will come out as the pelletizer chops the string by chopper, which now be ready to use as the raw material for plastic manufacturing. The residue can be extruded and feed again to this flow.

## **2.3 Occupational safety and health (OSH)**

### **2.3.1 OSH regulatory framework in Thailand**

Declaration of the “Occupational Safety, Health and Environment Act, B.E. 2554 (A.D. 2011)” (also referred to as “OSH Act”), was a remarkable milestone in the development of OSH law in Thailand which was endorsed by the cabinet resolution in December 2010. This OSH Act has become effective since July 16th, 2011, resulting in the abrogating of Chapter 8 of the Labor Protection Act 1998 and subordinate legislations by default ("Intenational labour Organization," 2016). However, several Ministerial Regulations related to OSH, those issued under Chapter 8 of the Labor Protection Act 1998, are still effective ("Safety and Health at Work Promotion Association (Thailand),").

### **2.3.2 Occupational safety and health program in Thailand**

*“Identify hazards in the workplace and assess the risk associated with them, to design the facility and management program to reduce risks associated with the hazards”* are the two main goals of an organization's OSH program. Also, communicate about identified hazards, assessed risks and appropriate safety measures within all employees is very important. The policy on “Decent Safety and Health for Workers” proposed by The Ministry of Labor to the government to be considered as the National Agenda. Cabinet of Thailand had adopted the resolution to announce this policy as the National OSH Agenda applied for all relevant sectors on December 11, 2007. The

following 7 objectives under this National OSH Agenda has been in effect from 2007 to 2016 ("International Labour Organization," 2016):

1. Ensure that OSH of workers has been promoted under the National Master Plan on Occupational Safety, Health and Environment.
2. Provide a safe working environment for workers in all sectors conforming to the OSH standards.
3. Raise the workers' awareness and enhance knowledge on OSH.
4. Decrease the rate of occupational accidents and injuries.
5. Develop OSH information that is fully accessible by workers.
6. Conduct systematic surveillance on OSH for workers.
7. Create a sustainable safety culture among workers.

The action plan for the above National Agenda has developed the National Master Plan on Occupational Safety, Health and Environment (2012 – 2016). This National Master Plan covers 5 strategies as follows:

- Strategy 1: Promoting labor protection with effective OSH standards
- Strategy 2: Promoting and strengthening the capacity of OSH networks
- Strategy 3: Developing and managing OSH knowledge
- Strategy 4: Developing an OSH data system
- Strategy 5: Developing an efficient mechanism for OSH administration

## **2.4 OSH conditions in relation to Heat, Noise and Light**

### **2.4.1 Heat**

Heat is a major physical hazard that can affect the health of the workers in a workplace and one of the most important and common occupational health problems in workplaces, where improper heat conditions can affect not only the health but also the productivity of workers (Kjellstrom, Holmer, & Lemke, 2009). Exposure to extreme thermal conditions is harmful to health ranging from illnesses to premature death (Tawatsupa et al., 2012). Workers who are exposed often to heat in their workplace have been identified suffering heat exhaustion, heatstroke, heart or lung disease, accidents, kidney disease, and injuries (Tawatsupa, Lim, Kjellstrom, Seubsman, & Sleigh, 2010). This is especially valid for the people who are doing heavy physical labor

as a part of their daily work are at certain risk, because these physical activities trigger heat strain health symptoms. Also, age, body size, pre-existing disease, gender, clothing, the capacity for heat acclimatization, and physical activity category factors can affect the health risks from heat stress (Tawatsupa et al., 2010).

On the other hand, high ambient temperature and humidity in tropical climates may impose higher heat-related occupational health and safety risks to the exposed workers in low-income countries (Venugopal, Chinnadurai, Lucas, & Kjellstrom, 2015). According to the previous researches conducted in Thailand, which is a developing country with a large workforce is usually exposed to heat due to Thailand's climatic conditions including high temperature and humidity. Besides, since low- and middle-income countries are mostly dependent on manual labor, it is important to maintain health and the welfare system for workers to sustained industrial growth. Nevertheless, due to a lack of providing cooling facilities for workers who are working in tropical developing countries has a possibility of confronting health problems caused by exposure to excessive heat (Venugopal et al., 2015).

#### **2.4.2 Noise**

Exposure to noise is one of the most common risk factors in the industrial environment, which impacts worker's health known as "*noise-induced hearing loss*". This illness also is known as "*occupational hearing loss*" which caused by continuous exposure to high sound pressure levels and it is one of the most common illnesses among industrial workers in the European Union which signifies one-third of occupational illnesses in Europe (Fernández, Quintana, Chavarría, & Ballesteros, 2009). Apart from that, noise exposure can cause several other risks for the safety and health of workers. the noise is also including the sound of speak and alarm. The problems of the noise like abnormalities in the vocal cords, loss of voice, and voice could be affected for the workers who have to communicate within noisy background higher than 85dBA noise.

#### **2.4.3 Light**

Lighting is a major factor that is important to the health and safety of the workers in any kind of workplace. This will assist to see and avoid a hazard quicker

and easier. Thus lightning is a compulsory factor in the workplace and the requirement of lightning is determined by the types of hazardous exist in the workplace (KRÁLIKOVÁ, 2015). Apart from that, improper lightning may cause other health problems such as severe headache, migraine, and eyestrain which are also linked with “Sick Building Syndrome”. The major symptoms of sick building syndrome are headaches, irritability, lethargy, and poor concentration. However, exposure to too much light is also a health risk which can cause glare headaches, and stress. Both situations can lead to mistakes at work, weak quality, and low productivity. Most studies recommended that improved productivity and a reduction in errors can be accomplished by good lighting at the workplace (Ismail, Rani, Mohd Makhbul, & Deros, 2007).

## **2.5 Hazard identification and risk assessment for SSEs**

Failure to identify or recognize current hazards, or that could have been expected is one of the root causes of workplace injuries, illnesses, and incidents (Sari et al., 2017). So, it is required to identify hazards actively and continuously to assess and control associated risk with corrective actions on a timely basis, while communicating relevant actions taken and findings with employees. This entire procedure will ensure an OSHMS integrated into work processes (Makin & Winder, 2008). However, SSEs which are usually short on resources can also carry out an effective risk assessment through simple measures including hazard identification, the requirement of a safety data sheet before purchasing products, and adequate training (Arocena & Núñez, 2010). Main efforts are still required to assist SSEs in implementing a cost-effective and practical way of bringing some elements of OSHMS into their OSH practices. Even though most SSEs do not have fully documented OSHMS, but it is able to establish a clear understanding of hazards and risks and effective controls (Champoux & Brun, 2003). Based on the size and technical means of an enterprise, several OSHMS steps could be simplified and adapted as compatible with those enterprises. In this case, the inclusion of simplified forms of risk assessment as an initial step of OSHMS implementation is recommended (Organization, 2011). These are based on basic primary prevention methodologies presented simply for SSEs, though



those insertions are not an exact OSHMS model. Therefore, hazard identification and risk assessment could be included as adapted basic elements of OSHMS.

Terminologies of hazard identification and risk assessment based on Thailand legislation ("Regulation of Department of Industrial Works. Re: Criteria for hazard identification, risk assessment, and establishment of risk management plan B.E. 2543 ", 2000).

- Risk: probability with which a hazardous event occurs and the consequences of the hazardous event.
- Acceptable level of risk: level of risk judged to be outweighed by corresponding benefits or one that is of such a degree that it is considered to pose minimal potential for adverse effects.
- Hazard: an agent or event capable of causing injury or illness from working, damage to property, the environment and public, or combination of all these.

### **2.5.1 Hazard identification**

Hazard identification is the process of identifying possible hazardous in the workplace or in the way of working. First, it is necessary to understand the nature of hazards and it is considered as a primary step of the entire process. People being exposed to hazardous substances, processes, or environment are some of the hazards that workers need to confront in the workplace and it can be categorized into six groups can be divided into six groups (Suhardi et al., 2018);

- Physical hazards: noise, electricity, heat, and cold.
- Chemical hazards such as toxic gases, noxious fumes, and corrosive liquids.
- Ergonomic hazards: height of a workbench, the shape of a vehicle seat, and the length of a control lever.
- Radiation hazards: x-ray radiation machines, high powered lasers, and radioactive materials.
- Psychological hazards: stress from using equipment without proper training or instructions, overwork, or being coerced into using faulty equipment which carries a risk of injury.

- Biological hazards: syringes containing potentially infected blood, specimen containers carrying potentially infected materials such as bacteria.

## 2.5.2 Occupational hazard identification and risk assessment in PSW recycling facilities

Currently, only a few research studies are available on OSH and risk assessment in PSW recycling facilities. Cioca et al. (2018) studied the main differences between a mechanical separation and manual separation of PSW, by assessing the health risk for the workers and conducting cost analysis. The main results showed that there is a possibility for risks due to the sharp waste, injuries, and sanitary danger while doing manual separation. But the quality of the material improved at mechanical separation than manual separation. In the mechanical shredding system of the plant, the risk from noise was significant among biological and other physical hazards (Figure 2.5).

Assessed Risk		Risks									
		Biological	Chemical	Noise	Vibration	Machine	Falling	Falling of Objects	Cuts	Effort	Fire
Operations	Waste charging	2	4	9	4	9	2	3	2	4	2
	Shredding	1	2	9	4	3	4	9	4	2	2
	Waste storage	2	2	6	4	6	2	3	4	4	1
	Waste movement	2	4	6	4	6	2	3	4	4	1
	Clean of the areas	2	4	9	2	9	4	9	6	2	1

Note: green = acceptable; yellow = low; orange = significant; red = high.

Figure 2.5 Risk matrix of the shredding system in a plastic recycling plant (Cioca et al., 2018)

## 2.6 VOCs emission from the melting process of plastics

### 2.6.1 Emissions from PSW recycling plants: the case of PP and PE

Several research studies reported that various toxic pollutants such as VOCs including alkanes, alkenes, chlorinated hydrocarbons, monocyclic aromatic hydrocarbons, Oxygenated VOCs (OVOCs), Chlorinated VOCs, and aldehydes, polycyclic aromatic hydrocarbons (PAHs), and phthalate esters (PAEs) are released during the melting extrusion process (He et al., 2015; Huang et al., 2013; Tsai, Chen, Chang, Chang, & Mao, 2009). He et al. (2015) investigated the pollution profile of volatile organic compounds releasing from plastic waste recycling workshops in a

different type of plastic solid waste, while identified the contribution of VOCs groups in each type of plastic waste (Figure 2.6). The results of the study showed that alkanes, alkenes, monoaromatics, and OVOCs are the main contributors in PP and PE recycling plants.

Alkanes are the most abundant VOCs for polyolefins, contributing 50.8% and 37.5% to the PE and PP recycling VOC emissions, respectively. Although, the TVOCs concentration found at PP and PE is lower compared to VOCs emitted at ABC and PS recycling plants. The low melting temperature of the extrusion process (150–250 °C) in the PE and PP was mainly attributed to the above significant decrease of TVOCs concentrations (Kiran Ciliz, Ekinici, & Snape, 2004). However, researches suggested that due to the aging, long thermal exposure, and the interactions between the additives and recycled PE and PP polymer waste, a fraction of VOCs were still released during the melting extrusion process.

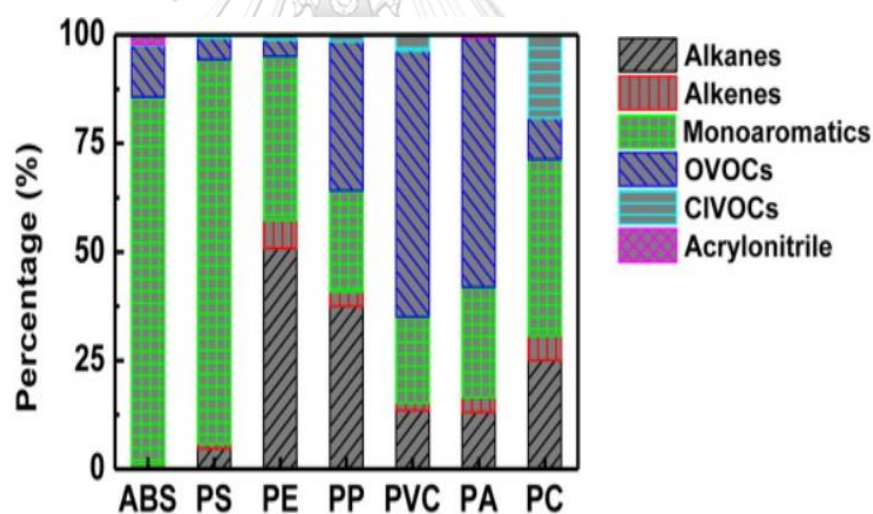

Figure 2.6 Percentage contribution of groups of VOCs emitted in different PSW recycling workshops during extrusion processes (He et al., 2015)

In another study on VOCs emission at PE/PP recycling plants, toluene, acetone, 2-butanone, formaldehyde, and acrolein were the higher-level compounds detected respective hydrocarbons, ketones, and aldehydes at PE production lines, while toluene was the highest respective hydrocarbons from emissions from PP production lines in the same plant (Tsai et al., 2009). As overall from the combination of PP and PE, volatile compounds emitted from the melting processes were mainly hydrocarbons and

ketones. However, referring to the olfactory threshold of individual compounds, ethylbenzene and acrolein in several samples exceeded human olfactory thresholds, and this indicated these compounds played the key roles to contribute the odor inside PE/PP plastic waste recycling plant. Moreover, more complicated, and hazardous compounds could be released into the work and ambient environment from the present melting operation in plastic waste recycling plants. Some researches indicated that the indoor environment is the most significant source of exposure for most VOCs which was highly recommended for HRA (Payne-Sturges, Burke, Breysse, Diener-West, & Buckley, 2004; Tsai et al., 2009). Effective management, therefore, must focus on indoor environments.

### 2.6.2 VOC species emitted in PP and PE melting

He et al. (2015) was compared VOCs emission in between PP and PE and recorded that the TVOC concentration during the PP extrusion was 20.7 times higher than that during the PE extrusion and it was highly noted. Similar results were obtained in the comparison between VOCs emitted in the melting process of virgin PP and LDPE with a lesser magnitude (K. Yamashita et al., 2009). However, there was a considerable difference in VOC species that were determined at PP and PE (Table 2.1) (He et al., 2015).

Table 2.1 Major VOC compounds emitted at PP and PE recycling plants (He et al., 2015)

PP		PE	
Compound	%	Compound	%
cyclopentanone	20.60%	i-pentane	20.4%
styrene	11.20%	n-undecane	13.5%
3-hexanone	10.20%	toluene	10.3%

Such a difference was mainly attributed to the different pyrolytic mechanisms between the two polymers. Chain scission of the macromolecules of PP proceeds along with thermo-oxidative and thermo-mechanical degradation which led to a decrease in the molecular weight by a series of radical reactions: oxidation, fragmentation, disproportionation, etc. (Hinsken, Moss, Pauquet, & Zweifel, 1991). In the case of PE, the formation of more nonvolatile macromolecule has resulted from chain scission with

chain branching and the crosslinking which took place simultaneously. Therefore, higher TVOC concentration and more OVOC were observed in the PP workshop than in the PE workshop (He et al., 2015).

### 2.6.3 Indoor sampling in previous studies

Many research studies were utilized different types of sampling, extraction, and analysis to determine indoor air VOC concentrations. Table 2.2 shows several works of literature, which used active sorbent sampling along with solvent extraction and GC/MS and GC with a flame ionization detector (FID) analysis.

*Table 2.2 Sampling and analytical procedures for the determination of VOCs in air*

Literature Source	Analytes	Sampling	Extraction and Analysis	RSD	LOD
Shanh et al. (2017)	20 VOCs	Indoor, Active, SB, 3.5-4 hr (NIOSH)	SE, GC-FID	nr	0.047-1.4 mg/m <sup>3</sup>
Scheepers et al. (2010)	5 VOCs	Indoor, Active/Passive, SB, 4 hr and 24hr	SE, GC/MS	5	0.85–1.2 µg/m <sup>3</sup>
Yoshida (2009)	18 VOCs	Indoor, Active, SB, 24 hr	GC/MS	0.8–9.3	0.4–1.7 ng/m <sup>3</sup>
Araki et al. (2009)	8 VOCs	Indoor, Active/Passive, SB, 48 hr	SE, GC/MS	nr	0.044–0178 µg/m <sup>3</sup>
Ohura et al. (2009)	9 VOC	Indoor and Outdoor, Active, SB 24 hr	SE, GC/MS	nr	3.6–54 ng/m <sup>3</sup>

*Note.* SB = sorbent enrichment; SE = solvent extraction; nr = not reported; RSD = relative standard deviation; LOD = limit of detection

### 2.7 Human health effects: Inhalation exposure

VOCs may be present in any environment; the exact health effects of this exposure are still unknown (Ralph J Delfino, Gong, Linn, Pellizzari, & Hu, 2003). Nevertheless, current evidence suggests that a substantial number of these VOCs can cause adverse health effects including sensory irritation, respiratory symptoms, and

even cancer. Exposure to VOCs is predominantly through inhalation compared to other exposure pathways (Sarma et al., 2011). Diversity of the health effects that individual VOCs can cause is varied with the diversity of the VOC group, ranging from no known health effects of relatively inert VOCs to highly toxic effects of reactive VOCs (E. Romagnoli, T. Barboni, P. A. Santoni, & N. Chiaramonti, 2014b). The major health effects are sensory, irritation and allergic effects, respiratory effects, and carcinogenic effects, and this range of possible health effects of VOCs is quite broad due to different chemical varieties of VOCs.

### **2.7.1 Non-Carcinogenic Effect**

The major potential non-carcinogenic effects from volatile organic compounds (VOCs) include acute and chronic respiratory effects, allergies, asthma, neurological toxicity, and eye and throat irritation (Rumchev et al., 2007). Buchdahl, Willems, Vander, and Babiker (2000) conducted an epidemiologic study that reported positive associations between cardiovascular health outcomes and ambient hydrocarbon. Also, previous epidemiologic studies reported positive associations between respiratory health outcomes and ambient hydrocarbons, aldehydes, and ketones (Ralph J Delfino et al., 2003; Ralph J. Delfino et al., 2010). Among them, Ralph J. Delfino et al. (2010) showed in a panel of asthmatic children that aldehyde (formaldehyde) and ketone (acetone) were associated with severe asthma symptoms with greater magnitudes compared to hydrocarbons (benzene, toluene, and xylenes) (Romagnoli et al., 2014b).

### **2.7.2 Carcinogenic Effect**

Many VOCs have been classified as either carcinogenic or mutagenic. The substances are categorized according to the weight of available evidence. The categories from the International Agency for Research on Cancer (IARC) include carcinogenic, probably carcinogenic, and possibly carcinogenic to humans under relevant groups (Table 2.3). Under this classification system, formaldehyde, benzene, and vinyl chloride are human carcinogens. Several VOCs including 1,3-butadiene, benzyl chloride, tetrachloroethylene, and trichloroethylene are classified as probable human carcinogens.

*Table 2.3 IARC's degree of evidence for cancer risk effects for chemical compounds*

<b>Group</b>	<b>Definition</b>	<b>No. of compounds identified</b>
Group 1	Carcinogenic to humans	120 agents
Group 2A	Probably carcinogenic to humans	83 agents
Group 2B	Possibly carcinogenic to humans	314 agents
Group 3	Not classifiable as to its carcinogenicity to humans	500 agents

## **2.8 HRA: PSW recycling plants**

The impacts of the plastic extrusion process on human health have been widely investigated by several authors by implementing HRA (He et al., 2015). A previous study observed that one VOC compound concentration exceeded the short-term exposure level limit published by NIOSH, which represented a potential health risk for employees because it was known to be mutagenic and carcinogenic (Tsai et al., 2009). Further researches on health risk assessments for this occupation should be considered. All of the plastic waste recycling plants in this study only used a filter to treat the melting fumes, and this could not efficiently eliminate the gaseous compounds. More efforts to exhaust air pollution control and the use of the personal respiratory protective equipment by employees are strongly recommended in these industries.

### **2.8.1 Occupational exposure limits**

He et al. (2015) found that only in the ABS and PS workshops, the Occupational exposure limit value ( $E_i$ ) for TVOCs was more than 1.0, indicating that workers in these two workshops might suffer from potential health risks from the emitted VOCs. For the other workshops, due to its low TWA–TLV, benzene contributed to the majority of  $E_i$ , accounting for 67.1% and 43.4% of TVOC for  $E_i$  in PE & PP workshops, respectively. But potential health impacts could not be completely ignored through the  $E_i$  values of other workshops were below 1.0.

### 2.8.2 Non-cancer risk

Also, He et al. (2015) were assessed non-cancer effects according to the reference dose values for 31 VOC species. Based on the indoor concentrations, the Hazard Index (HI) with a value of 0.56 for PE and 0.25 for PE workshops which were lower than 1.0, indicating lower risk. In the indoor microenvironment of the PVC and PE recycling workshops, benzene was also the main contributor (accounting for 39.1% and 38.9% of total HIs) with the highest HIs of 0.29 and 0.22, respectively. In the PP workshop, the highest risks were from 1,3,5-trimethyl benzene (0.044), benzene (0.050), and toluene (0.0037). Generally, benzene, toluene, ethylbenzene, styrene, methylene chloride, and trichloroethylene were the major contributors to the chronic health effects in these workshops.

### 2.8.3 Cancer risk

According to the IARC, nine of the investigated VOCs in He et al. (2015) are classified into three cancerogenic categories. The cumulative lifetime cancer risk (LCR) in the indoor microenvironment of the PE accounting for  $5.56 \times 10^{-5}$  and  $3.02 \times 10^{-5}$  in PP workshops. It was noted that the residents have been posed definite cancer risks near the PS, PA, ABS, and PVC recycling workshops when posed a probable risk in other workshops. Out of identified compounds, benzene verified into group 1, trichloroethylene and tetrachloroethylene into group 2A, and ethylbenzene, styrene, methylene chloride, trichloromethane, 1,2-dichloromethane, and acrylonitrile for group 2B. While acrylonitrile, styrene, ethylbenzene, and 1,2-dichloromethane were the major contributors to cancer risks, like tumors of the lungs, liver, kidneys, and brain via inhalation exposure (Ye et al., 2017).



## CHAPTER 3

### RESEARCH METHODOLOGY

This study was conducted to identify occupational hazards and assess health risks associated with VOCs to ensure the safety and health of workers in small scale plastic recycling facilities in Thailand. The research framework used to achieve this task is as follows (Figure 3.1).

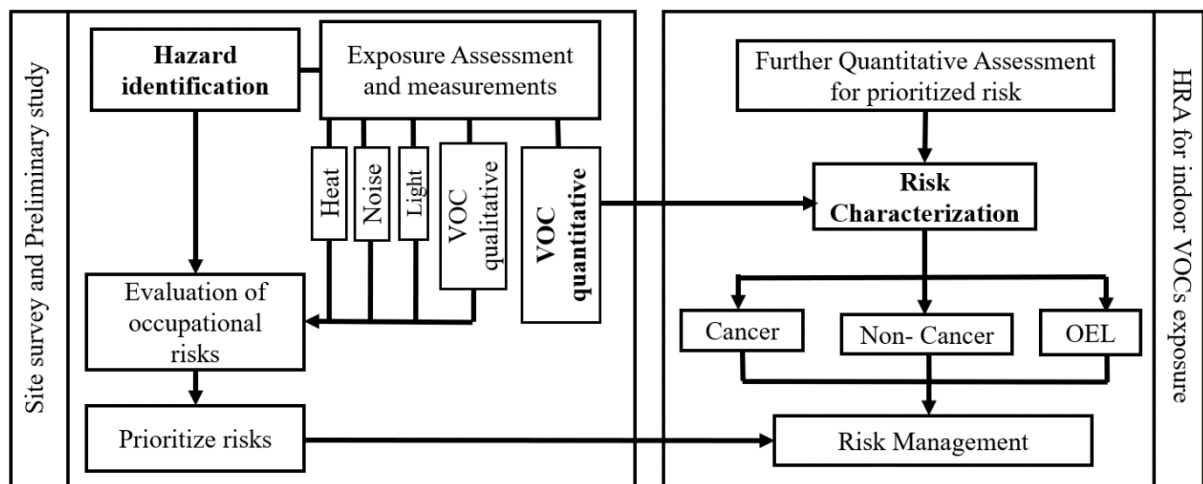

*Figure 3.1 Overall framework of this research*

### 3.1 Case studies

Figure 3.2 shows the two main areas of this study used to accomplish the objectives of this study. Accordingly, four plastic waste recycling factories located in Samutprakarn and Bangkok province were selected as case studies of this research (Table 3.1). Occupational hazard identification and semi-quantitative risk assessment were implemented for all four factories as a preliminary study to evaluate risk levels from identified hazards for further QRA. Based on the outcomes of the preliminary study and previous literature, HRA was implemented only on two selected recycling plants mainly under two recycling practices out of preplanned three practices by considering limitations such as accessibility, factory status, and global pandemic situation. The human health risk from indoor exposure of VOCs at different plastic waste recycling processes was investigated. The details of each plastic plant's layout, common details, and working microenvironment conditions were considered in site survey under the hazard identification.

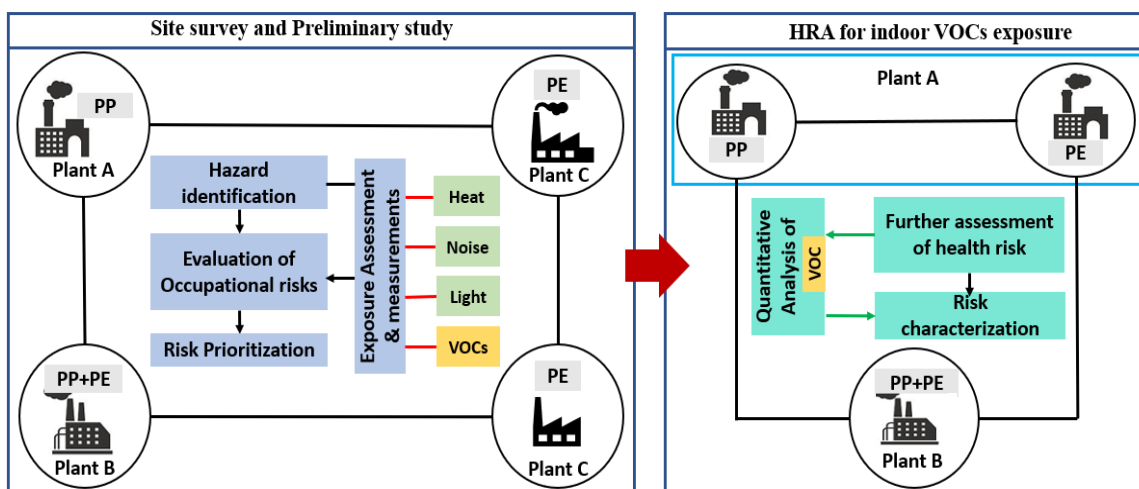

Figure 3.2 Scope of the study

Table 3.1 Comparison of similarities and differences among selected plastic recycling plants

Detail		Plant A	Plant B	Plant C	Plant D
Raw materials/ Product		PP	PP and PE	PE	PE
Capacity (tons/ month)		36 (30%) of PP rest 70% - HDPE	300-400 (PP – 60% & PE – 40%)	210	140
No. of production lines		1	2	1	1
Recycling processes (Additional steps)	Manual sorting	<input checked="" type="checkbox"/>	<input checked="" type="checkbox"/>	<input checked="" type="checkbox"/>	<input checked="" type="checkbox"/>
	Washing	<input checked="" type="checkbox"/>			
	Color sorting	<input checked="" type="checkbox"/>			<input checked="" type="checkbox"/>
	Homogenize	<input checked="" type="checkbox"/>	-		
Extrusion temperature (°C)		220	220-250	180	180
Heavy load handling @main station		Forklift trucks	Manually + Trolleys	Manually + Trolleys	Forklift trucks
Fume extraction systems		Well maintained	Well maintained	Outdated	Absent
PPE		Absent	Absent	Absent	Absent

Registered under factory type 53(5) of Thai Ministry of Industry	Yes	Yes	No	No
--	-----	-----	----	----

### 3.2 Site survey and preliminary study

Preliminary research included occupational hazard identification and occupational risk evaluation for prioritizing risks for further QRA. Exposure assessment was implemented as a crucial step in this entire preliminary research to estimate the magnitude, frequency, and duration of exposure from identified hazards. The results of the preliminary study were used to manage and control potential risks. Therefore, relevant risk evaluations and estimations were carried out to determine potential risks from identified hazards. Accordingly, the checklist method was applied to all recycling plants to inspect for hazards based on Thai regulations of the Department of Industrial works: Criteria for hazard identification, risk assessment, and establishment of the risk management plan, BE 2543, and guidelines given by International labor organization (ILO) ("International labour Organization," 2016; "Regulation of Department of Industrial Works. Re: Criteria for hazard identification, risk assessment, and establishment of risk management plan B.E. 2543 ", 2000). As noted under Thai guidelines, implementation means to design, production process, receiving, storage, transfer, use, transport, raw material, fuel, chemicals or hazardous substances, products and byproducts, operating practice, machinery or equipment used in production, and other activities or conditions in a factory.

#### 3.2.1 Hazard Identification

Hazard is an agent or event capable of causing injury or illness from working, damage to property, the environment, and the public, or a combination of all these. This research study is mainly focused on physical and chemical hazards

A checklist consisted of question-related for implementation to determine whether it has been done according to design standard, operating standard, or the law to bring the inspection result to identify hazards and evaluate the risks. Steps for studying, analyzing, and reviewing the implementation of a factory to identify hazard using the Checklist method were listed as follows:

Step 1: Aspects were set for safety in implementation.

Step 2: Detail description of such aspects to be inspected was outlined by considering the operating procedure, legal matters concerning safety and occupational health, and safety standard.

Specific areas of the worksite premises and activities carried on in those premises were examined for the first two steps. The process outline is given below:

- The worksite plan was accessed.
- A chart was formulated to show the process of production or workflow.
- The worksite was divided into identifiable areas and was numbered. This division was based on the production process or the physical layout of a site.
- Staff in all areas were interviewed to list other potential hazards in the working station and the owners were consulted for the required information.
- Also, other sources of hazard information were utilized to identify hazards.

Step 3: The information in step 2 was used to constitute a checklist for a safety inspection.

Step 4: Accuracy and completeness of the checklist were checked, and it was rechecked by expertise to assure that the checklist covers all aspects concerning existing safety problems.

Step 5: The checklist was used to inspect safety in the implementation of the factory.

Step 6: Results from inspection in assessing risk were used to prioritize risk associated with a potential hazard.

Step 7: Risk management procedure was established according to the risk level determined from the assessment and was filled into the form.

### **3.2.2 Exposure Assessment**

#### **3.2.2.1 Heat stress**

##### ***Environmental parameters measurement***

All the environmental parameters which were given by Quest temp WBGT meter were recorded along with Wet Bulb Globe Temperature (WBGT) readings taken

in heat stress exposure measurements. Accordingly, dry bulb temperature, wet bulb temperature, and relative humidity relative to all WBGT readings were recorded.

### ***Heat stress measurement***

The exposure assessment was carried out according to the American Conference of Industrial Hygienists (ACGIH) and Ministerial regulations of Thailand on OSH (*Heat Stress and Strain: TLV® Physical Agents 7th Edition Documentation 2017*; "Summary Ministerial Regulation on the Prescribing of Standard for Administration and Management of Occupational Safety, Health and Work Environment in Relation to Heat Light and Noise," B.E. 2549 (2006)).

- ACGIH standard: Consist of 5 steps.
- Thai ministerial regulations: Step 1, 3 and 5

#### ***Step 1: Determining Wet Bulb Globe Temperature (WBGT<sub>in</sub>)***

The Indoor Wet Bulb Globe Temperature (WBGT<sub>in</sub>) index was used to represent the heat stress to which an individual is exposed. The WBGT readings were taken by using Quest temp WBGT meter at the main two points within all recycling plants (Figure 3.3). One point was close as possible to workers who had the potential to subject heat stress at the extrusion process (Figure 3.4). The other point was roughly the center of the main workstation (MWS), where many workers were performing their tasks. The first reading was taken after 20 min from a point of inspection. After that, 10 readings were taken from the same point for each one-minute interval to determine the average value. Finally, three regions of the body as head, abdomen, and ankle were selected for the measurement of WBGT based on the standards (ISO, 1989, BS EN, 1994).

Obtained WBGT values were then averaged from the Eq.1. This decision was taken based on the fact that all activities are conducted in the standing posture within all the workplaces. Accordingly, all the measurements were taken at a corresponding height for above mentioned three regions as 0.1, 1.1, and 1.7 m (3 points) above the floor (next to the extrusion line and middle of the main station).

$$\text{WBGT} = (\text{WBGT}_{\text{head}} + (2 \times \text{WBGT}_{\text{abdomen}}) + \text{WBGT}_{\text{ankle}}) / 4 \quad (\text{Eq.1})$$

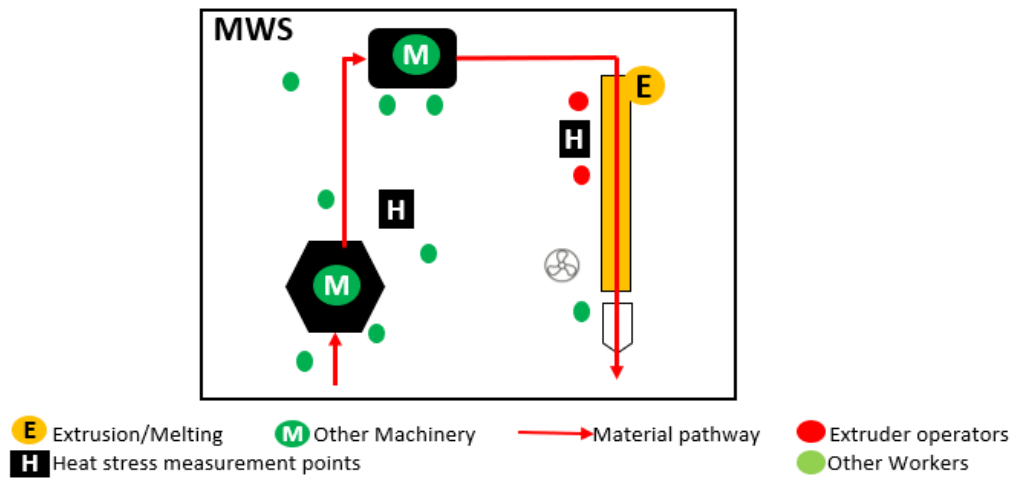

Figure 3.3 The generalized layout to represent all recycling plant for WBGT inspection points for heat stress exposure assessment

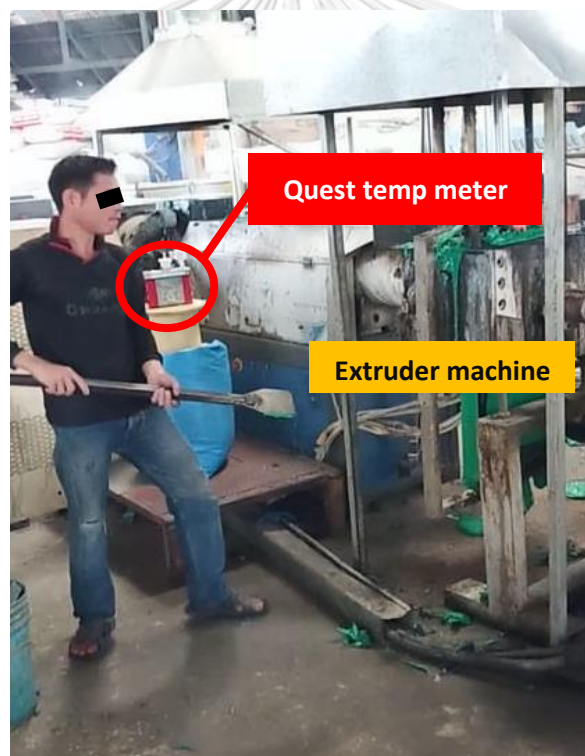

Figure 3.4 The WBGT inspection point at the extrusion process (abdominal level) in one of a recycling plant

**Step 2: Add Clothing Adjustment Factor (CAF) to Determine WBGT Effective**

**Step 3: Determine the Metabolic work rate**

The ACGIH metabolic work rates represent impacts to the body core temperature from the heat produced internally as exertion increases. The work category

was selected from ACGIH standards that best represents the workload. For the Thai standard of ministerial regulation for administration and management of OSH in relation to heat, light, and noise, the metabolic work rate category was selected according to the type of the work done by the worker.

***Step 4: Determine the Threshold Limit Value (TLV) or Action Limit (AL)***

Hazard from heat for an acclimatized worker was presented by TLV temperature and AL is the temperature used for a non-acclimatized worker. TLV or AL was determined by using the standard ACGIH curves.

***Step 5: Screening Criteria for ACGIH TLV and Action Limit for Heat Stress Exposure***

ACGIH's screening criteria for TLV and AL heat stress tables (Table 3.2 and Table 3.3) were used as a screening tool to evaluate whether a heat stress situation exists based on WBGT, workload, and work/rest regimen.

*Table 3.2 Threshold limit values for occupational heat stress measurements (ACGIH) (Heat Stress and Strain: TLV® Physical Agents 7th Edition Documentation 2017)*

% Work	Workload			
	Light	Moderate	Heavy	Very Heavy
75 to 100%	31.0°C	28.0°C	N/A	N/A
50% to 75%	31.0°C	29.0°C	27.5°C	N/A
25% to 50%	32.0°C	30.0°C	29.0°C	28.0°C
0% to 25%	32.5°C	31.5°C	31.5°C	30.0°C

*Table 3.3 Action limit values for occupational heat stress measurements (ACGIH) (Heat Stress and Strain: TLV® Physical Agents 7th Edition Documentation 2017)*

% Work	Workload			
	Light	Moderate	Heavy	Very Heavy
75 to 100%	28.0°C	25.0°C	N/A	N/A
50% to 75%	28.5°C	26.0°C	24.0°C	N/A
25% to 50%	29.5°C	27.0°C	25.5°C	24.5°C
0% to 25%	30.0°C	29.0°C	28.0°C	27.0°C

**3.2.2.2 Noise level**

In the preliminary survey performed at hazard identification, a detailed noise survey was performed as the observations indicated the necessity for more specific monitoring as below (Denisov, 2018):

- SoundPro noise dosimeter was used to all specific information about the noise levels at selected inspection points closer to shredding, extrusion, and pelletizing machinery (Figure 3.5).
- Noise levels were measured at a distance from machinery, where machine operators and other workers are usually operating the machinery and performing their tasks.
- Worker exposure was evaluated and averaged out over an 8-hour workday under the guidelines of ISO 9612: 2009 ((ISO), 2009).
- Usage of appropriate hearing protection is defined for the areas identified as a noise hazard area.

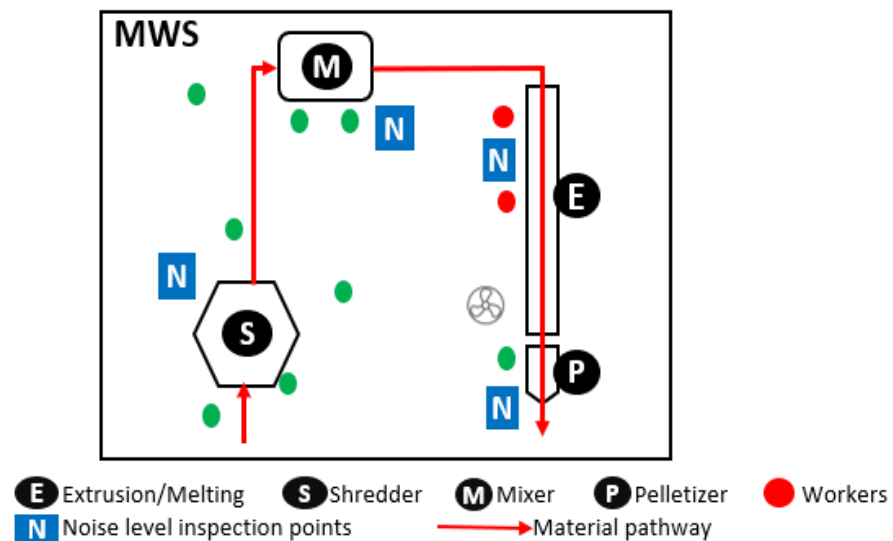

Figure 3.5 The generalized layout to represent all recycling plant for Noise level inspection points for noise survey

### 3.2.2.3 Light

All the light measurements were performed by Light meter 407026. The measurement procedure consisted of the following steps (*Assessment of light from work*);

- 1) A map of the measurement area was created to show the location of the equipment working area, natural light direction, the position of general lighting sets, and lamp spots.



2) Average measurement was taken for two specified areas (Figure 3.6 and Figure 3.7) the average measurement of the area is a measure of the light intensity in general areas within an establishment, such as walkways and utility areas of the production process in which the employee works (Eq.2 and Eq.3).

- I. A single light in the middle of the room (Symmetrically located single luminaire)

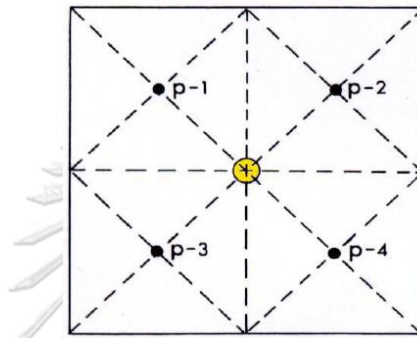

Figure 3.6 Light measurement of a room with a single middle light (Assessment of light from work)

$$\text{Average light} = [p1 + p2 + p3 + p4]/4 \quad (\text{Eq.2})$$

- II. The single row of individual luminaires

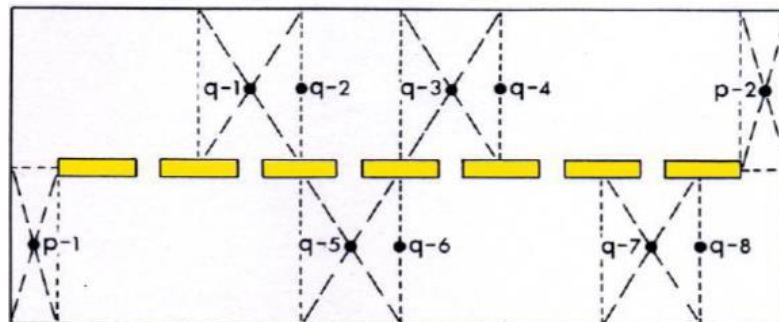

Figure 3.7 Light measurement of a Single Row of Individual Luminaires (Assessment of light from work)

$$\text{Average light} = [Q (N - 1) + P]/N \quad (\text{Eq.3})$$

Where,

N= number of bulbs

The measurement procedure was included,

1. Read all 8 q values and find the average value as Q
  2. Read both p points and find the average value as P
  3. Substituted the Q, P, and N values according to the formula to get the measurement
- 3) Inspection results were compared with standard values. Such as the ministerial regulations on administration and management of OSH and environment in working on heat, light, and sound or global standard.

### 3.2.3 Risk evaluation and estimation

#### 3.2.3.1 Risk matrix method

Risk evaluation was performed as a combination and modification of criteria approved by the Thailand Department of Industrial works and similar occupational study findings (Ramesh, S, & Senthilkumar, 2017; "Regulation of Department of Industrial Works. Re: Criteria for hazard identification, risk assessment, and establishment of risk management plan B.E. 2543 ", 2000). The risk level was set by considering the multiplication product between probability level and severity level of the event affecting workers. The following levels were used to assess the probability (Table 3.4) and severity levels (Table 3.5).

*Table 3.4 Probability levels for risk evaluation and estimation ("Regulation of Department of Industrial Works. Re: Criteria for hazard identification, risk assessment, and establishment of risk management plan B.E. 2543 ", 2000)*

Level	Probability	Description
4	Almost certain	Constant exposure to hazard. Very high probability of damage.
3	Likely	Frequent exposure to hazard. High probability of damage.
2	Possible	Regular or occasional exposure to hazard. Moderate probability of damage.
1	Unlikely	Infrequent exposure to hazard. Low probability of damage.

Table 3.5 Severity levels for risk evaluation and estimation (Ramesh et al., 2017)

Rating	Noise	Heat	Gases
1	75 to 84 dBA	Frequent Perspiration at work	Odor, itching
2	85 to 94 dBA	Heatstroke (Mental or psychological strain or transient Heat Fatigue)	Suffocation, Respiratory tract damage, Eye irritation, sneezing, Temporary Headache
3	95 to 104 dBA	Heat Exhaustion (Fainting, Eye disorder, Nausea), Heat Cramps, Throbbing, Headache	Prolonged exposure, Chronic Respiratory failure, or other occupational diseases
4	≥105dBA	Heat Stroke/ Exhaustion leads to death or permanent damage	Overexposure which may lead to immediate death

### 3.2.4 OSH data interpretation

- Heat exposure: All the final measurements were compared and analyzed along with each plastic recycling practice due to their difference in extrusion/melting temperatures.
- Noise exposure: All the final measurements were compared and analyzed along with selected process stages (closer to machinery) and point of inspection for all 4 plants.
- Light measurement: All the final measurements were compared and analyzed along with all 4 plants.
- The evaluated occupational risk was compared based on current OSH conditions of the recycling plant which mainly reflected the legal status.
- Also, all the heat, noise, and light measurements were compared based on current OSH conditions of the recycling plant which mainly reflected the legal status.

### 3.3 Indoor quantitative VOC analysis

#### 3.3.1 Air Sampling and analytical method

Samples were collected and analyzed under different NIOSH methods for the determination of selected groups of VOCs in the ambient air (*NIOSH Manual of Analytical Methods (NMAM)*, 2016).

##### 3.3.1.1 Sampling at sites

For each plastic recycling practice, a total of 36 samples were collected by considering 8 samples for each subject including duplicates at 4 different times per day (time slots) as to cover 8h working per day (Table 3.6). All the recycling plants have proceeded with the recycling practices of PP and PE based on the monthly schedule or plan. It was defined by the recycling capacity percentage which was specified for each recycling plant. Generally, one recycling practice of either PP or PE (one type of plastic) is recycled within an entire working day and the type of plastic that recycles is changed daily or weekly basis during a month. Table 3.7 shows the recycling practices which was carried out in selected recycling plants during the sampling days.

Table 3.6 Sampling plan for each recycling plant

Subject	NIOSH method	Sorbent tube	No. of samples at each time slot			
			8.00-10.00	10.00-12.00	12.00-14.00	14.00-16.00
Ketones	1300	Zefon ZST-001	2	2	2	2
Hydrocarbon	1500	Zefon ZST-001	2	2	2	2
Aromatic Hydrocarbon	1501	Zefon ZST-001	2	2	2	2
Formaldehyde	2541	XAD-2	2	2	2	2

*Table 3.7 Recycling practices conducted at each recycling plant on sampling days*

Sampling Day	Recycling plant	Recycling practice (the type of plastic) carried out	Any other recycling practice carried or not	Time slots of samplings
Day 01	Plant A	PP	No	4
Day 02	Plant A	PE	No	4
Day 03	Plant B	PP	No	4

Figure 3.8 shows the procedure that was followed in sampling at sites of study. Sorbent tubes, such as charcoal tubes were used for air sampling based on the group of VOCs. According to the NIOSH standards for air sampling (Table 3.8), the sorbent tubes were connected to a personal sampling pump with a flow rate recommended by NIOSH, and sampling lasted for a period to achieve the minimum volume. The connected sorbent tubes with GilAir plus sampling pumps were kept near the breathing zone of workers at extrusion and the high-risk zone which were categorized in hazard identification to obtain the concentration of VOCs inside premises (Figure 3.9). A field blank sample was obtained with each group of samples in the workplace. The samples were sealed properly and were stored under 4<sup>0</sup> C for transportation and storage.

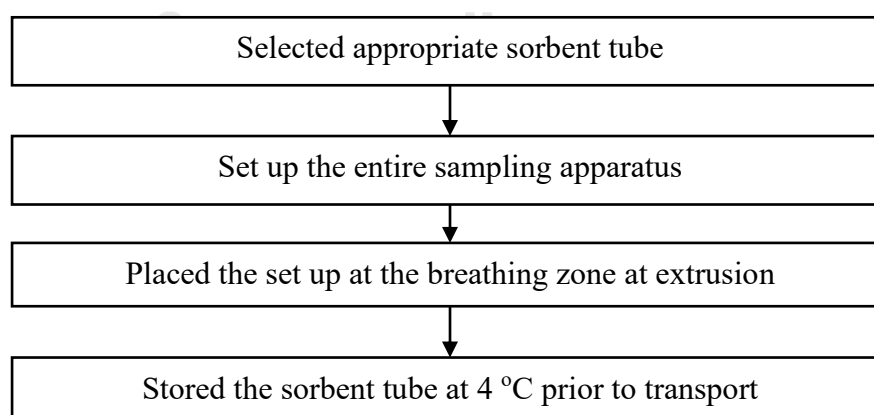
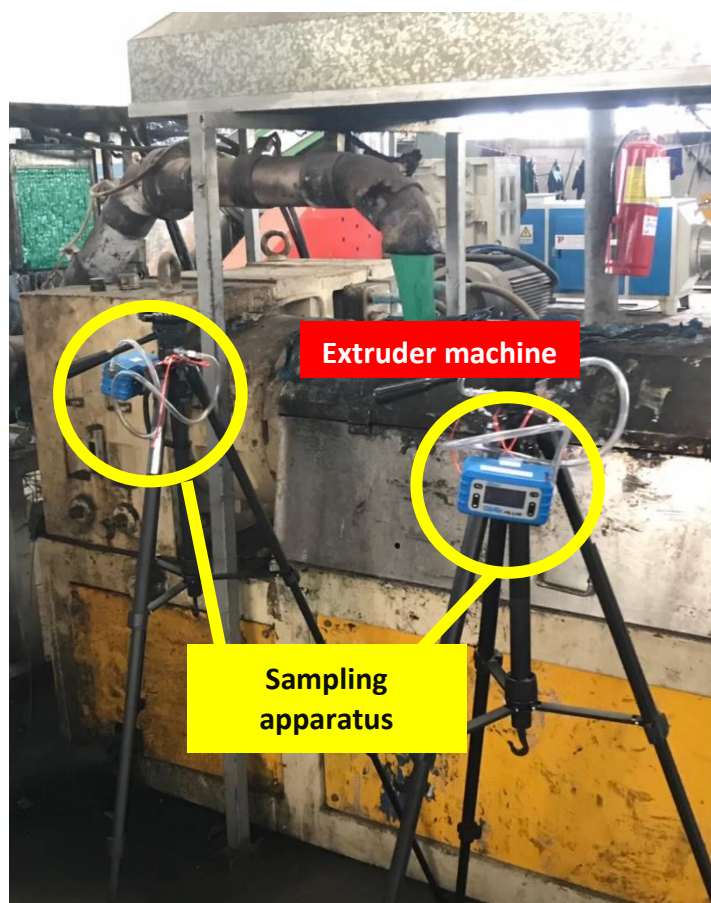

*Figure 3.8 Sampling procedure for indoor quantitative VOC analysis of plastic recycling plants*

Table 3.8 NIOSH standard methods for air sampling and analysis of VOCs

Sampling Method	Group of VOCs	Compounds	Flow rate (L/min)	Volume (L)
NIOSH 1300	Ketones	acetone	0.2	3
		cyclohexanone		
		di-isobutyl ketone		
		2-hexanone		
		methyl isobutyl ketone		
		di-isobutyl ketone		
NIOSH 1500	Hydrocarbons	cyclohexane	0.2	4
		cyclohexene		
		n-decane		
		n-dodecane		
		n-heptane		
		n-hexane		
		methylcyclohexane		
		n-nonane		
		n-octane		
		n-pentane		
		n-undecane		
NIOSH 1501	Aromatic hydrocarbons	benzene	0.2	6
		p-tert-butyl toluene		
		cumene		
		ethylbenzene		
		alpha-methyl styrene		
		beta-methyl styrene		
		toluene		
		o-xylene		
		m-xylene		
		p-xylene		
		styrene		

NIOSH 2541	Formaldehyde		0.1	6
---------------	--------------	--	-----	---



*Figure 3.9 Placement of the sampling apparatus for VOC concentrations at breathing zone of workers at extruder machine*

### 3.3.1.2 Extraction of samples

The procedure that was followed in the preparation of samples is shown in Figure 3.10. In the sample preparation, front and backup sections of sorbent tubes were transferred to vials. Then, sorbent matter was desorbed with chemical solutions with 1 mL of carbon disulfide and standing for at least 30 minutes. The supernatant CS<sub>2</sub> solution was analyzed by chromatography.

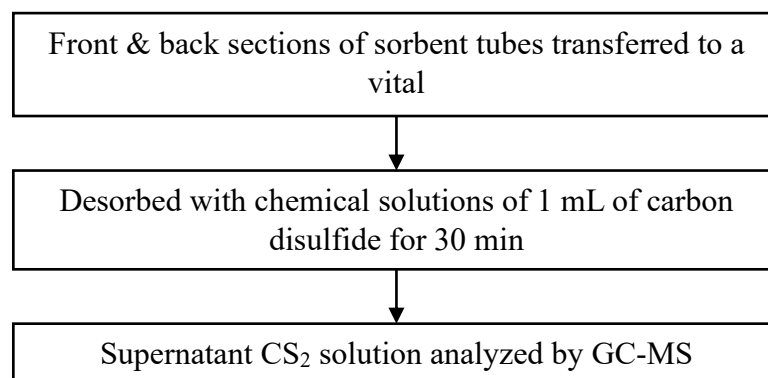

*Figure 3.10 Extraction procedure of indoor quantitative VOC analysis of plastic recycling plants*

### 3.3.1.3 Quantitative analysis

Air samples were qualitatively and quantitatively analyzed by a Gas chromatograph equipped with an FID detector. An Agilent 6890 Gas Chromatograph equipped with a split-split less injector and flame ionization detector (FID). Helium was used as a carrier at a flow rate of  $2.6 \text{ mL min}^{-1}$  (according to NIOSH method). The oven temperature was initially kept at  $40^\circ\text{C}$  for 4 min and gradually increased to  $125^\circ\text{C}$  at a rate of  $10^\circ\text{C min}^{-1}$  and then to  $230^\circ\text{C}$  at a rate of  $70^\circ\text{C min}^{-1}$ . The frontlet temperatures were set at  $250^\circ\text{C}$ . Chromatographic separation was carried out using a fused silica capillary column (30m x 0.32-mm ID; 1- $\mu\text{m}$  film 100% PEG or equivalent). Identical GC-FID conditioned followed for NIOSH 1500 and 1501 methods (Table 3.9), where different conditions for NIOSH 2541 method (Table 3.10)

*Table 3.9 GC-FID condition for NIOSH 1500 and 1501 methods*

Carrier gas	Helium
The flow rate of carrier gas	$2.6 \text{ mL min}^{-1}$
Column	30m x 0.32-mm ID; 1- $\mu\text{m}$ film 100% PEG or equivalent
Inlet temperature	$250^\circ\text{C}$
Initial temperature	$40^\circ\text{C}$
Initial holding time	4 min
Over ramp conditions	1 <sup>st</sup> ramp $10^\circ\text{C min}^{-1}$ to $125^\circ\text{C}$ (hold 1 min) 2 <sup>nd</sup> ramp $70^\circ\text{C min}^{-1}$ to $230^\circ\text{C}$ (hold 1 min)
Run time	16 min
Type of detector	FID
Split ratio	5:1
FID detector temperature	$230^\circ\text{C}$
Injection volume	1 $\mu\text{L}$



*Table 3.10 GC-FID condition for NIOSH 2541 method*

Carrier gas	Helium
The flow rate of carrier gas	2.8574 mL min <sup>-1</sup>
Column	60 m x 250 μm x 0.25 μm
Over ramp temperature	70°C for 2 min then 5°C min <sup>-1</sup> to 150°C for 2 min
Run time	20 min
Type of detector	FID
Temperature injector	250°C
Temperature detector	300°C
Split ratio	5:1
FID detector temperature	230°C
Injection volume	5 μL

### 3.3.1.4 VOC emission profile and analysis

The types of VOCs determined were categorized for each type of recycling plants separately to calculate the percentage of those VOC groups or species upon plastic recycling practice type. Data analysis was performed with SPSS statistical software for all obtained values. A comparison between the mean of VOCs concentration of a group, compound, and/or TVOCs in indoor air (dependable variables) along the plastic recycling practices (independent variable) was carried out by a Tukey test in one-way ANOVA.

### 3.4 Human health risk assessment of indoor VOC exposure

The quantitative analysis was carried out to determine VOC concentrations within the premises as the main aspect of exposure assessment of QRA. Then human risk characterization was performed to determine.

- Occupational exposure limits (OEL) for workers
- Cancer risk for workers
- The non-cancer risk for workers

#### 3.4.1 Calculation of mean concentration of VOCs exposed to workers

The calculation of the mean concentration of a particular kind of VOC exposed to the workers from PP or PE recycling practices of a plastic recycling plant ( $C_{PE}$  or  $C_{PP}$ ) of an 8-hour shift was calculated according to Eq.4.

$$C_{PE \text{ OR } C_{PP}} = (C_{8-10} + C_{10-12} + C_{12-14} + C_{14-16}) / 4 \quad (\text{Eq.4})$$

Where,

$C_{8-10}$  = Indoor concentration of a VOC compound within 8.00am to 10.00am

$C_{10-12}$  = Indoor concentration of a VOC compound within 10.00am to 12.00pm

$C_{12-14}$  = Indoor concentration of a VOC compound within 12.00pm to 14.00pm

$C_{14-16}$  = Indoor concentration of a VOC compound within 14.00 pm to 16.00 pm

### 3.4.2 Estimate risk characterization criteria

After the calculation of mean concentrations, all the risk characterization estimation was performed under two criteria.

1. Real-time situation: Exposure duration from a particular VOC concentration (either toluene or hexane) within a specific recycling plant within a specific period (per month) has varied with the multiple recycling practices (either PP and PE) carried on during that period (Figure 3.11). To avoid the under or overestimation of risk characterization parameters, the mean concentration of a particular VOC of a recycling plant was adjusted or corrected based on the percentage recycling capacity of PP and PE according to the monthly schedule. Then these adjusted concentrations calculated using Eq.5 were used to characterize cancer and non-cancer risks.

$$C_{ad} = ((PP\% \times C_{PP}) + (PE\% \times C_{PE})) / 100 \quad (\text{Eq.5})$$

Where,

$C_{ad}$  = Adjusted mean exposure concentration of a VOC in a recycling plant

PP% = Percentage of production or recycling of PP per month of a plant

PE% = Percentage of production or recycling of PE per month of a plant

$C_{PP}$  = Concentration of a VOC compound released at extrusion of PP

$C_{PE}$  = Concentration of a VOC compound released at extrusion of PE

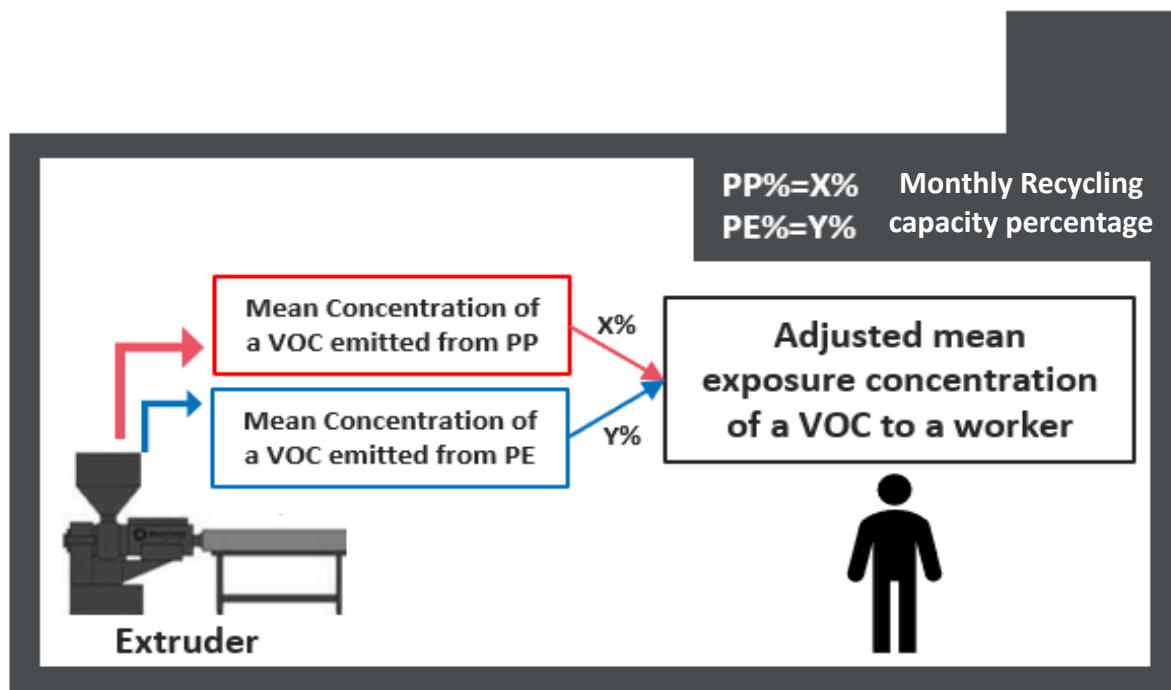

Figure 3.11 Real-time scenario for quantitative health risk characterization of VOCs emitted from plastic recycling plants

2. Comparison scenario: The difference in the non-cancer or cancer risk from VOCs emitted at specific to PP and PE were compared using this scenario. Here, the recycling capacity of 100% for both PP and PE was considered once at each without considering the real-time situation. No adjusted concentration was used in this criterion.

### 3.4.3 Occupational exposure limits (OEL) for workers

The OEL for a human is defined by the European directive, following the ISO and ACGIH, for some hazardous VOCs inhaled by workers (E. Romagnoli, Toussaint Barboni, P. A. Santoni, & N. Chiaramonti, 2014a). ACGIH standards of recommending maximum chemical exposure to workers are updated annually for both acute and chronic health issues. But it is required to mention that these exposure levels are not legally limited or regulated. Here, short-term exposure to workers given by threshold limit values (TLV), and the long-term exposure based on 8 working hours per day according to time-weighted average (TWA) standards. Accordingly, the Eq.6 was used as a simple model of occupational exposure index ( $E_i$ ) assessment based on the VOC data in this study and TLV–TWA.

$$E_i = C_i / (\text{TLV-TWA}_i) \quad (\text{Eq.6})$$

Where  $C_i$  ( $\text{mg m}^{-3}$ ) was the mean concentration or adjusted concentration of a particular VOC in indoor air. In the workshop, VOCs with  $E_i$  above 1.0 are deemed to pose a potential health risk to the employee.

#### 3.4.4 Cancer risk for workers

To quantify the health risks of workers in plastic recycling plants, carcinogens were distinguished from non-carcinogens. The chronic exposure of these carcinogens was concentrated on risk assessment as these chemicals may cause cancer. The inhalation cancer risk for each compound was estimated using the Eq.7.

$$\text{Lifetime cancer risk (LCR)} = \text{Chronic Daily intake (CDI)} \times \text{Slope factor (SF)} \quad (\text{Eq. 7})$$

The SF is the slope of the dose-response curve at very low exposures. The dimension of the SF is expressed as the inverse value of daily intake ( $\text{mg/kg/day}^{-1}$ ) (USEPA). The VOCs, including benzene and other carcinogenic compounds, were considered for quantitative VOC analysis in this study due to the availability of SF, high possibility in formation, and carcinogenic effect. Different parameters were considered in calculating the intake of contaminants, including frequency, duration of exposure, and the bodyweight of the worker. Compounds with LCRs more than  $1 \times 10^{-4}$  will be considered as “definite risk”, between  $1 \times 10^{-5}$  and  $1 \times 10^{-4}$  as “probable risk”, between  $1 \times 10^{-5}$  and  $1 \times 10^{-6}$  as “possible risk” and less than  $1 \times 10^{-6}$  as “negligible risk”. Moreover, the chronic daily intake (in  $\text{mg/kg/day}$ ) was computed according to the Eq.8 for each worker who was categorized as high risk for VOC exposure in recycling practice separately.

$$\text{CDI} = (C_i \times \text{IR} \times \text{ED} \times \text{EF} \times \text{L}) / (\text{BW} \times \text{AT} \times \text{NY}) \quad (\text{Eq.8})$$

where  $C_i$  was the mean concentration or adjusted concentration of a particular VOC in indoor air ( $\text{mg/m}^3$ ). IR is the inhalation rate ( $\text{m}^3/\text{h}$ ), ED denotes the exposure time (h/week), EF represents the exposure frequency (weeks/year), L is the length of exposure (years), BW is the body weight (kg), AT is the average time of lifetime exposure (period over which exposure is average), NY is the number of days per year.

For calculation of risk assessment in the Thailand context, IR values were assumed as 2.5 m<sup>3</sup>/h for adult males and 1.5 m<sup>3</sup>/h for adult females based on the workload category (*U.S. EPA. Exposure Factors Handbook (Final Report) 2011*). However, BW, ED, EF, and L were obtained from interviewing workers and owners (Appendix C). In this case, individual BW, ED, EF, and L were considered for the group of workers who are at the highest risk (e.g: extruder machine operators) and individual values to substitute for Eq.8 to reduce the underestimation of risks. For the lifetime chronic risk, the length of exposure (L) was taken as the number of years that a worker possibly works on the recycling facility from the recruited year until 60 years of age at retirement.

### 3.4.5 Non-cancer risk for workers

#### 3.4.5.1 Hazard quotient

In contrast to the cancer risk, hazard quotient (HQ) was used to express the noncancer risk of workers which is defined as the ratio of the estimated exposure concentration ( $C_i$  in mg/m<sup>3</sup>) of an individual to the RfC (Eq.9) (Shanh et al., 2017). It is the ratio of the potential exposure to a chemical substance and the level at which no adverse effects are expected.

$$\text{Hazard quotient (HQ)} = C_i / \text{RfC} \quad (\text{Eq.9})$$

The RfC values were obtained from the Integrated Risk Information System (IRIS) (USEPA). Adverse noncancer effects are unlikely to affect on workers when the hazard quotient is below 1.0. In other terms, it can be considered to have negligible. But the potential for adverse non-cancer effects increases when  $\text{HQ} \geq 1.0$ , where the magnitude of the illness is not known.

#### 3.4.5.2 Hazard Index

Hazard Index (HI) is the sum of the noncancer effect of a chemical compound that affects the same target organ or organ system. Hence, HI is expressed in terms of summation of all HQs as total noncarcinogenic hazard attributable to exposure to all VOCs through a single exposure pathway (Eq.10) (USEPA).

$$\text{HI} = \sum \text{HQ} \quad (\text{Eq.10})$$

Also, it is defined as the ratio of the estimated chronic daily intake to the RfD via inhalation for all VOCs detected (Eq.11) (Chang, Wei Chi, Li-Xuan, & Chiang, 2010). As with the hazard index, non-cancer health effects for a target organ/system over a specified lifetime of exposure from all the VOC species to a worker could be estimated in contrast to previously calculated HQ. But similar to HQ, an adverse non-cancer effect likely will result when  $HI \geq 1$ . Here, RfD values for inhalation were obtained from the IRIS of USEPA. But in a previous study, HI values for each VOC also calculated without using the summation for the comparative analysis purpose of HIs among different kinds of VOC (He et al., 2015).

$$HI = \sum CDI / RfD \quad (\text{Eq.11})$$

#### 3.4.6 Cumulative estimate risk characterization

In the process of evaluating predicted cumulative health risks from multiple VOCs (TVOCs) detected at a recycling plant, estimate health risks for each VOC were required to summed to obtain from the above models of OEL and cancer risk as in Eq.12 (He et al., 2015). This cumulation risk was not carried out for the HI model as it gives the cumulative risk by its definition.

$$\text{Cumulative cancer or non-cancer risk} = \sum \text{cancer or non-cancer risk of a VOC} (\text{Eq.12})$$

This helped to represent the percentages of each VOC species contribution for cumulative risk. However, It required to assume that there are no synergistic or antagonistic chemical interactions within compounds where it targets the same organ or system with the same effect on humans in the application of these models for cumulative non-cancer or cancer risk assessment (He et al., 2015).

#### 3.4.7 Assumptions and limitations for HRA

Moreover, several assumptions regarding individual exposure were taken into consideration to ease the process of exposure and risk assessment, based on the literature and questionnaire data (Duangduan & Cheevaporn, 2008; Guo, Lee, Chan, & Li, 2004).

Assumption and limitations for overall risk assessment:

1. The exposure route used in this study was only by inhalation and assumption of inhalation rates used for calculation.
2. All data used in this study were taken from all available human and animal studies and the quality of researches was not be determined.
3. The long-term exposure percentage of different VOCs from PP and PE for a worker at the 8h working shift was assumed similar to the monthly recycling capacity percentage (PP% and PE%) of each recycling plant.
4. The VOC concentrations that are taken for a short period is assumed to remain the same for the long-term exposure period for a particular recycling plant.



## **CHAPTER 4**

### **RESULTS AND DISCUSSION**

#### **4.1 Site survey**

##### **4.1.1 Plant A**

The plastic waste recycling plant A is located in Samutprakarn province. Industrial PP waste plastics were used for pelletizing and outcomes used as raw materials in industrial plastic manufacturing. This recycling plant has a manufacturing capacity per month of 36 tons of PP which is accounted for 30% of monthly recycling capacity and rest 70% of recycling capacity occupied by PE plastic recycling practice. Generally, this facility is recycled only one type of plastic (one recycling practice of either PP or PE) within an entire working day and the type of plastic that recycles is changed daily or weekly basis. Apart from that, this establishment is registered as a factory producing plastic products from waste plastic under type 53 (5) of the Ministry of Industry, Thailand.

##### **4.1.1.1 Production process**

This factory consisted of one production line from sorting to pelletizing with the most advancing recycling process compared to all other three recycling plants. The initial sorting of plastics is performed manually at a very basic level. After sorting, plastics are shredded into a smaller size that is easier to be processed. In the washing process, the shredded plastics are cleaned to remove contaminants by using surfactant and then dried. The washing and shredding processes were not carried out all working days. Here, the required amount of plastic for the particular production day was shredded and washed in advance. Shredded plastics or flakes are separated into different colors from a color separation machine. This step is very crucial in maintaining the quality and standards of the final product according to persistence color requirements. After, that color sorted flakes are loaded into vertical mixing silos to homogenize flakes with different physical properties to increase the efficiency of the extrusion process. These homogenized plastic flakes are fed to the screw loader connected with the hopper of the extruder. Compressed and melted plastic flakes screwed to the die head as spaghetti-like plastic strings through a filter screen to remove any solid particles/residue



wastes. Then these strings are cooled by passing them through a water bath. Cooled strings were supported by rollers placed at the end of the water basin is strained into the pelletizer where those strings cut into short, uniform pellets. Finally, pellets are packed and stored at the warehouse. Figure 4.1 shows the process flow diagram of plastic waste recycling of Plant A.

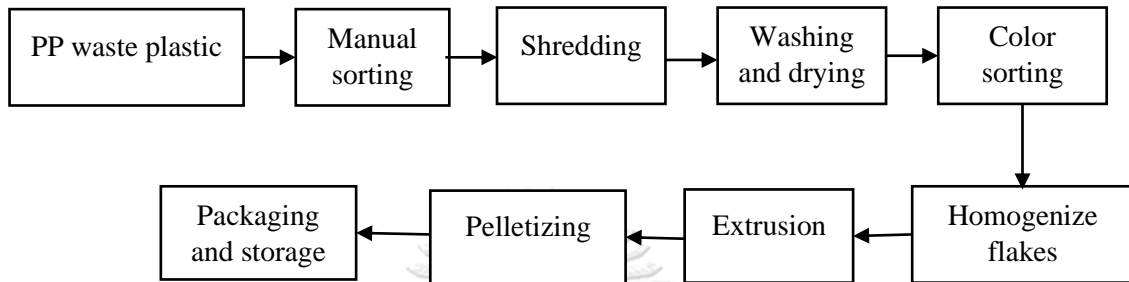

*Figure 4.1 Process flow diagram of plastic recycling plant A*

#### **4.1.1.2 Description of infrastructure facilities and working environment**

The entire recycling facility consists of a large warehouse and MWS, where the recycling processes from sorting to packing take place (Figure 4.2). All the machinery is placed within the MWS by allocating appropriate distances for material handling. Also, those arrangements are facilitated workers to engage in their tasks efficiently. The raw materials are transferred to the main working station (MWS) by a forklift truck and final products are also transferred back to the warehouse in a similar way (Figure 4.3). The pathways of the forklift truck were very clear along with the MWS. Due to the access of the forklift truck to almost all the places within the workplace, the manual handling of heavyweights is very limited. The shredding process is normally performed by two workers who operate the machine at the same time at a distance lesser than one meter. The considerable workforce is required to load and handle sorted plastics into the shredding machines. Also, two workers for operating the vertical mixing silos which require lesser manpower. There is a screw loader connected to the mixing silos to load the flakes. Mechanical pullies are used to transport homogenized flakes towards the extrusion.

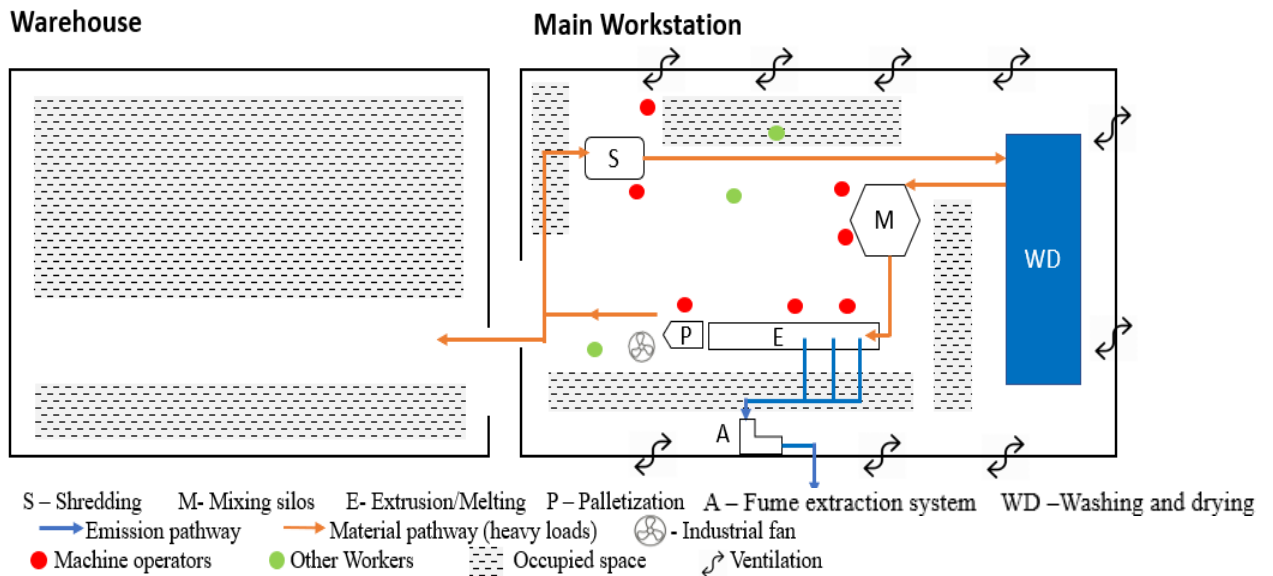

Figure 4.3 Schematic layout of the plastic recycling plant A



Figure 4.2 Infrastructure facilities and working conditions of the Main workstation in plastic recycling plant A

Normally, the extrusion machine is operated by two operators. Equipment similar to a shovel is used to handle the molten plastic within the ongoing process by those operators while standing very closer to the extrusion machine (less than 1m). That type of work requires greater force or energy. Altogether, a maximum of ten workers are worked for a shift (normally 8h) within the MWS and these workers are not usually assigned into one task at a time. Therefore, the majority of workers are

multi-tasking on situation wise. Moreover, the extruder machine was operated only by assigned operators for a shift although he engaged in other tasks related to the same processing line.

The large five air inlets of the fume extraction system are placed above the extrusion machine's openings, where a lot of emissions taking place (Appendix A). It was clear that the fume extraction system intakes a major portion of those emissions from the machine based on observations. Entire air filtration is customized according to the requirement of the recycling plant. Filtered air from the extraction system was released to the outside environment through a chimney. Still, a strong odor and some extent of breathing difficulty were observed at the premises, because of continuous emissions from the extrusion. However, ventilation within the MWS is through outlets on the main door and openings beyond the roof at both sides of the buildings. One industrial fan is placed at extrusion also facilitates ventilation at extrusion. The height of the building was approximately 7 m above ground and made up of steel. However, pelletizing is operated and monitored by one operator, and pellets are filled automatically into the packaging bags with a minimal workforce.

#### **4.1.1.3 Resource consumption**

Plant A consumed approximately overall 63m<sup>3</sup> of water per month. Approximately, 50 m<sup>3</sup> of water used in the production processes including the cleaning. Specifically, the washing process utilized NP9, as detergents, approximately 1 L (for producing 1 ton of recycled plastic pellets). Electricity used in the plastic waste recycling processes is about 8,515 kWh per month. Besides this, forklift trucks consumed diesel and gasoline fuels for transporting recycled plastic products approximately 115 L and 86 L per month, respectively.

#### **4.1.2 Plant B**

The plastic waste recycling plant B is located in Bangkok province. PE and PP waste plastics are used for pelletizing and outcomes used as raw materials in industrial plastic manufacturing. The composition of the types of PE used is not clear, it is a combination of both LDPE and HDPE. Out of all four plants, this plant has the largest manufacturing capacity per month of 300-400 tons, comprising 60% of PP recycling

practice and 40% of PE recycling practice, respectively. In most days, this facility is recycled only one type of plastic (one recycling practice of either PP or PE) within an entire working day and the type of plastic that recycles is changed daily basis. But during certain days it combined both PP and PE recycling practices, by recycling PP on one processing line and PE on other processing lines. Apart from that, this establishment was registered as a factory producing plastic products from waste plastic under type 53 (5) of the Ministry of Industry, Thailand.

#### 4.1.2.1 Production process

This factory consisted of two production lines from shredding to pelletizing comprised with a basic overall production process without washing, color sorting, and homogenizing flakes. Initial sorting of plastics was performed manually to remove unwanted items and debris attached to the plastic raw materials. This recycling plant only receiving plastic waste which was already cleaned by the raw material suppliers. After sorting, plastics are shredded to a smaller size for the convenience in upcoming processes. The shredding process was not carried out every day. Here, the required amount of plastic for the particular production day was shredded in advance. These shredded plastic flakes are fed to the hopper of the extruder. In the extruder, compressed and melted plastic flakes screwed to the die head as spaghetti-like plastic strings through a filter screen to remove any solid particles/residue wastes. Then these strings are cooled by passing them through a water bath. Cooled strings were supported by rollers placed at the end of the water basin is strained into the pelletizer where those strings cut into short, uniform pellets. Figure 4.4 shows the process flow diagram of plastic waste recycling of Plant B.

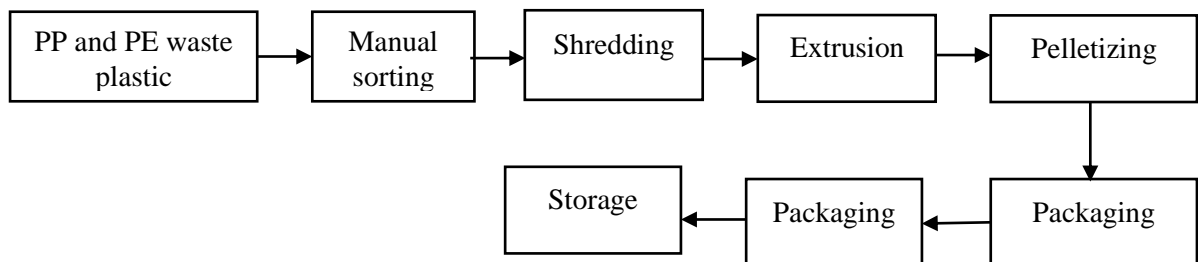

*Figure 4.4 Process flow diagram of plastic recycling plant B*

#### 4.1.2.2 Description of infrastructure facilities and working environment

The entire recycling facility consists of a large warehouse and MWS which was separately partitioned for extrusion. All recycling processes from sorting to packaging has taken place in the main station (Figure 4.5). All the types of machinery are placed within the MWS by allocating appropriate distances for material handling as similar to Plant A. Also, those arrangements are facilitated workers to engage in their tasks efficiently. The raw materials are transferred to the MWS by a forklift truck and final products are also transferred back to the warehouse in a similar way. There is no access to the forklift truck within the MWS. Due to the unavailability of the forklift within the workplace, the handling of heavyweights is done by using trolleys (Figure 4.6). The shredding process is normally performed by four workers to operate two machines at the same time by standing at a distance lesser than one meter next to the machine. The higher workforce is required to load and handle sorted plastics into the shredding machines. Also, machine operators at extrusion are assigned to transport shredded flakes towards the hopper of extrusion machines.

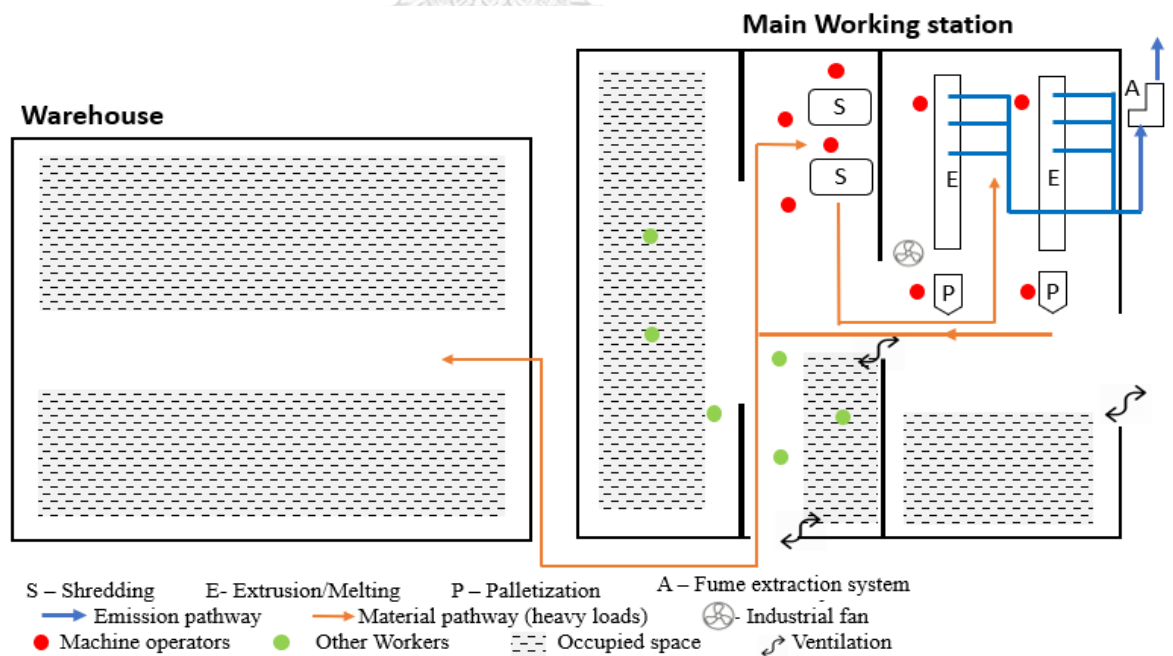

Figure 4.5 Schematic layout of the plastic recycling plant B





*Figure 4.6 Infrastructure facilities and working conditions of the Main workstation in plastic recycling plant B*

Normally, each extrusion machine is operated by one operator. There is some degree of handling of molten plastic within the ongoing process by those operators in the same way as Plant A. Also, they are engaged in the inspection and adjustment of strings while standing very closer to the extrusion machine. That machine operators of extrusion work are performed a heavy workload compared to Plant A. Altogether, a maximum of twelve workers was worked for a shift (normally 8h) within the MWS. Out of these workers, many were not usually assigned to one task at a time except workers at manual sorting and raw material handling. Moreover, the extruder machines are operated only by assigned operators for a shift although he engaged in other tasks related to the same processing line.

The air inlets more than six of the fume extraction system is placed above each extrusion machine openings, where a lot of emissions taken place (Appendix A). Here also, it is observed that the fume extraction system intake major portion of those emissions from machines. Entire fume extraction and filtration are customized according to the requirement of the recycling plant and all inlets are connected to one main inlet which transfers air to the fume extraction systems. Filtered air from the filtration system was released to the outside environment through a chimney. Still, a

strong odor and some extent of breathing difficulty are observed at the premises, because of continuous emissions from the extrusion identical to Plant A. However, ventilation within the MWS is mostly from outlets on side-doors. One industrial fan is placed at extrusion also facilitates ventilation at extrusion. Apart from that only a few exhaust fans are fixed at the roof of the buildings. The MWS was made up of cement and concrete at a height of approximately 8 m above ground. Pelletizing is operated and monitored by one operator and pellets are filled automatically into the packaging bags. Finally, pellets are packed and stored at the warehouse.

#### **4.1.2.3 Resource consumption**

Electricity consumption in the processes of recycled plastic resin production amounted to 90,250 kWh per month. Diesel-powered forklift trucks consumed about 195 L of diesel fuel per month in the transportation process.

#### **4.1.3 Plant C**

The plastic waste recycling plant C is located in Samutprakarn province near to recycling plant A. HDPE waste plastics were used for pelletizing and outcomes used as raw materials in industrial plastic manufacturing. This recycling plant has a manufacturing capacity per 7 tons per day. However, this establishment is not registered as a factory producing plastic products from waste plastic under type 53 (5) of the Ministry of Industry, Thailand

##### **4.1.3.1 Production process**

This factory consisted of one production line from shredding to pelletizing comprised of a basic overall production process without any sorting, washing, color sorting, and homogenizing flakes. This recycling plant is mainly receiving clear HDPE residues as raw materials from industries. Initially, plastics are fed to the hopper of the extruder where shredding has taken place first to reduce the size of raw materials for higher efficiency in extrusion. The shredding process was not carried out every day. Here, the required amount of plastic for the particular production day was shredded in advance. In the extruder, compressed and melted plastic flakes screwed to the die head as spaghetti-like plastic strings through a filter screen to remove any solid particles/residue wastes. Then these strings are cooled by passing them through a water

bath. Cooled strings were supported by rollers placed at the end of the water basin is strained into the pelletizer where those strings cut into short, uniform pellets. Figure 4.7 shows the process flow diagram of plastic waste recycling of Plant C.

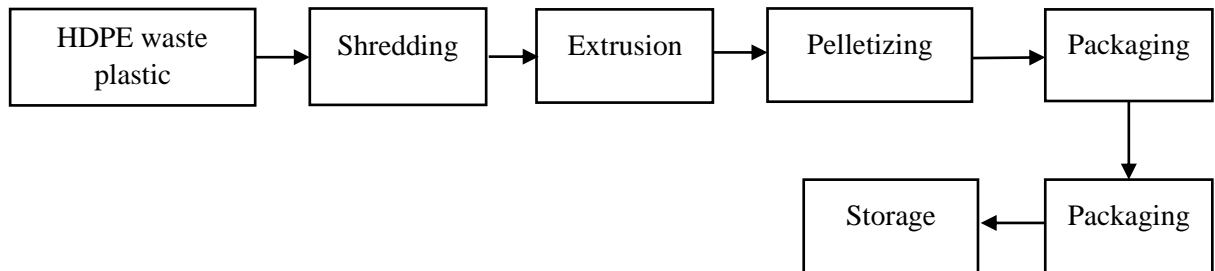

*Figure 4.7 Process flow diagram of Plant C*

#### **4.1.3.2 Description of infrastructure facilities and working environment**

This is the recycling plant with the most compact working space which could be defined as the worst working environment (Figure 4.8). The entire recycling facility consists of a comparatively smaller warehouse than Plant A and B, which is partitioned into two sections for storage and recycling process. In the recycling section, all recycling processes from shredding to packaging taken place (Figure 4.9). All the types of machinery are placed within that section without allocating appropriate distances for material handling. Also, the arrangements of materials and types of machinery are stood as a barrier for workers to engage in their tasks efficiently. The raw materials are transferred manually to the main working section using trolleys and final products are also transferred back to the storage section in a similar way. Due to the unavailability of any mechanical equipment within the workplace, the handling of heavyweights was done manually (Figure 4.8). The shredding process is normally performed by a worker to load the raw materials to a conveyor belt. The lower workforce is required to load and handle sorted plastics into the shredding machines because of the low weight of HDPE bags.





Figure 4.8 Infrastructure facilities and working conditions of the Main workstation in plastic recycling plant C

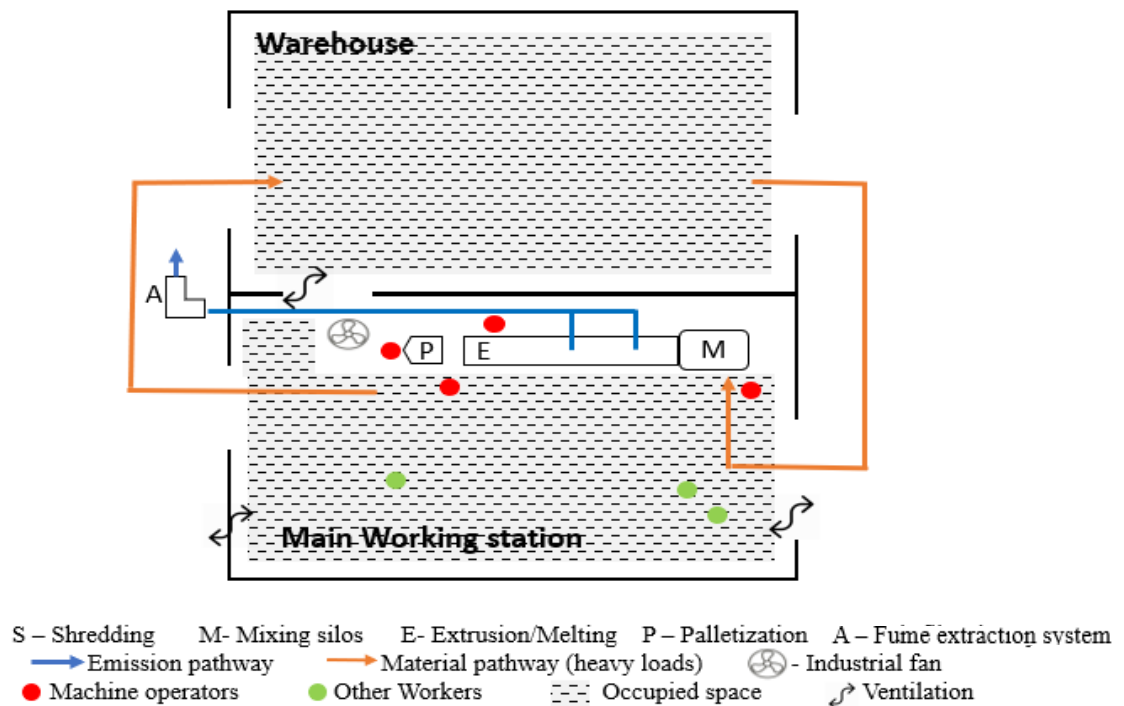

Figure 4.9 Schematic layout of the plastic recycling plant C

Normally, the extrusion machine is operated by two operators. There is the handling of molten plastic within the ongoing process by those operators in the same way as Plant A. Also, they are engaged in the inspection and adjustment of strings while standing very closer to the extrusion machine. That machine operators of extrusion work are performed a heavy workload compared to Plant A and B. Altogether, a

maximum of seven workers was worked for a shift (normally 8h) within the MWS and these workers were not usually assigned into one task at a time. Moreover, the extruder machine was operated only by assigned workers for a shift although he engaged in other tasks related to the same processing line.

The large air inlet of an outdated fume extraction system is placed above extrusion machine openings, where a lot of emissions taken place. Here, it was not observed that the fume extraction system intake a major portion of those emissions from machines due to visible fumes or emissions that are highly spreading all over the place. Filtered air from the filtration system was released to the outside environment through a chimney. Therefore, a strong odor and high extent of breathing difficulty were observed at the premises, because of continuous emissions leakage from the extrusion and inadequate ventilation compared to both Plant A and B. Moreover, ventilation within the MWS is mostly by outlets on side-doors. One industrial fan is placed at extrusion also facilitates ventilation at extrusion. The MWS is made up of steel at a height of approximately 4 m above ground. However, pelletizing is operated and monitored by one operator, and pellets are filled automatically into the packaging bags. Finally, pellets are packed and stored at the warehouse.

#### **4.1.4 Plant D**

The plastic waste recycling plant A is located in Bangkok province near to recycling plant D. HDPE waste plastics were used for pelletizing and outcomes used as raw materials in industrial plastic manufacturing. However, this establishment was not registered as a factory producing plastic products from waste plastic under type 53 (5) of the Ministry of Industry, Thailand.

##### **4.1.4.1 Production process**

This factory consisted of one production line from shredding to pelletizing with a basic overall production process without any sorting, washing, color sorting, and homogenizing flakes as similar to Plant C.

#### **4.1.4.2 Description of infrastructure facilities and working environment**

The entire recycling facility has consisted of a comparatively smaller warehouse than Plant A and B, which is partitioned to two sections for storage and recycling processes like Plant C. In the recycling section, all recycling processes from sorting to packing take place (Figure4.10). All the types of machinery are placed within that section with allocating some distances for material handling. This recycling plant is not as compact as Plant C. The raw materials are transferred using a forklift truck to the main working section and final products are also transferred back to the storage section in a similar way. The shredding process is normally performed by a worker to load the raw materials to a conveyor belt. The lower workforce is required to load and handle sorted plastics into the shredding machines because of the low weight of HDPE bags and light raw materials.

Normally, the extrusion machine is operated by two operators. There is some handling of molten plastic within the ongoing process by those operators in the same way as Plant A. Also, they are engaged in the inspection and adjustment of strings while standing very closer to the extrusion machine (Figure4.11). That machine operators of extrusion work are performed a heavy workload compared to Plant A and B. Altogether, a maximum of six workers was worked for a shift (normally 8h) within the MWS and these workers were not usually assigned into one task at a time. Moreover, the extruder machine was operated only by assigned workers for a shift although he engaged in other tasks related to the same processing line.

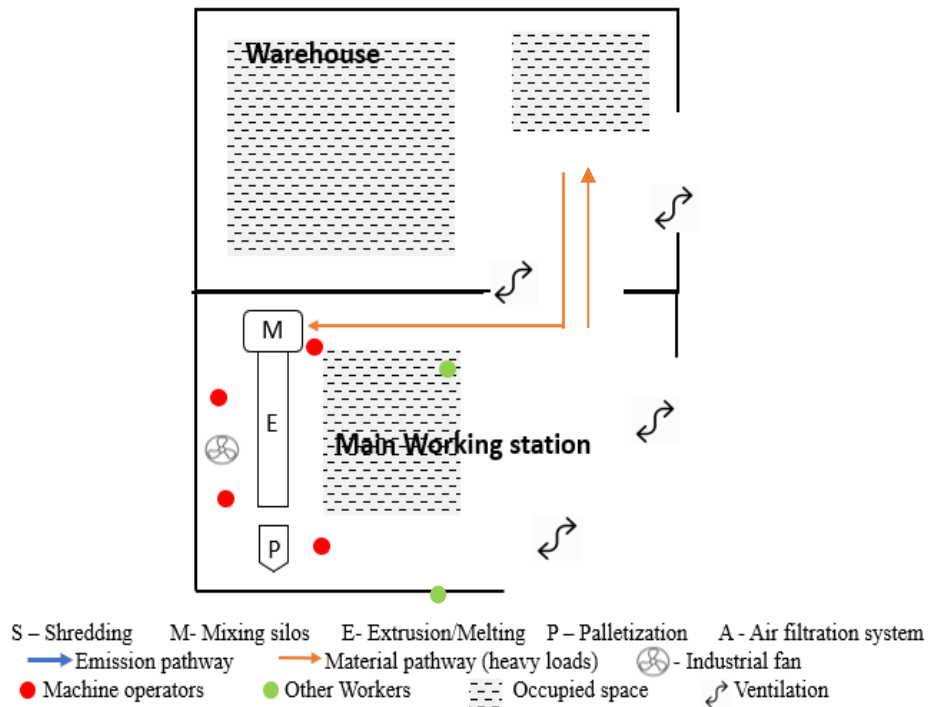

Figure 4.10 Schematic layout of the plastic recycling plant D



Figure 4.11 Infrastructure facilities and working conditions of the Main workstation in plastic recycling plant C

There is no fume extraction system installed for the extrusion machine. Here, it was observed a lot of visible fumes or emissions are highly spread all over the place. Therefore, a strong odor and some extent of breathing difficulty were observed at the

premises, because of the absence of a fume extraction system and low ventilation compared to both Plant A and B. Moreover, ventilation within the MWS is mostly from the open side of the factory. One industrial fan was placed at extrusion also facilitate ventilation at extrusion. The MWS was made up of steel at a height of approximately 6 m above ground. Nevertheless, pelletizing is operated and monitored by one operator, and pellets are filled into the packaging bags. Finally, pellets are packed and stored at the warehouse.

## **4.2 Preliminary Study**

In preliminary studies of this research work mainly consisted of three stages

1. Hazard identification
2. Exposure measurement and assessment
3. Occupational risk evaluation

### **4.2.1 Hazard identification**

Hazard Identification procedure was carried out for all four recycling plants from the initial stage of recycling to the final stage. This entire procedure was executed within the site survey study by focusing on the various hazards of different equipment's and process which were examined in that survey. As the initial step of this entire hazard identification procedure, the checklist method was used to review the design standard, operating standard, and safety regulations to identify the nature of the hazard at each process and equipment. Here, worksite plans and process flow diagrams were accessed in the site survey study used to divide all worksite areas into two major stations as the MWS and warehouse. All the recycling practices from sorting to the packaging were included in the MWS for the convenience in exposure and risk assessment, which was followed by the hazard identification step.

Physical and chemical hazards were the main two groups of hazards identified in this step other than ergonomic and biological hazards. Accordingly, heat and noise were categorized as the major physical hazards and VOC was categorized as the only chemical hazard. Figure 4.12 shows several areas and processes which was inspected under the hazard identification procedure within different recycling plants. It was observed that the heat released from extruders which were operating at a temperature range of 180 °C to 250 C directly exposed extruder operators who were operating the machinery in the long run.



Here, melted plastic at the above temperature and heaters in the extruder were the sources of heat that transmitting through the extruder barrel to the outside temperature by convection. Higher temperature readings than outside temperature were reported at the extruders as a result of this heat release, though these types of machinery were equipped with heat insulators. Also, none of the employees were dressed in suitable protective wear against the heat. However, a similar situation was experienced with noise hazards. Here, high loudness was observed at all the shredding machinery where shredder operators were directly exposed to that noisiness without any protective wear. Apart from the above two physical hazards, inadequate illumination levels or light intensities were observed at some crucial locations within facilities which will create a possibility to occur occupational accidents.



*Figure 4.12 Several areas and process inspected under the hazard identification: (A) Extrusion; (B) Shredding; (C) VOCs emission from extruders; (D) Warehouse*

Other than physical hazards, VOCs emitted from the extruders was determined as the main chemical hazard from plastic recycling plants. The visible fumes emitted at the extruder machinery resulted in a certain degree of breathing difficulty and odor nuisance within the premises even though fume extraction systems were installed for those

emitted fumes. Also, it was observed that these sensations were fairly unbearable with the long stay inside the factories. Furthermore, it was determined that all workers within the MWS with the inclusion of the extruder were exposed to emitted VOCs, as these emissions were from the indoor sources.

The usage of industrial waste plastic instead of municipal waste plastic as the raw material relieves the occupational risk from biological hazards at the manual sorting process. According to Cioca et al. (2018), manual sorting of municipal plastic waste posed a higher occupational risk to workers at sorting stations due to contaminations of pathogens from plastic surfaces. Apart from that, higher usage of forklifts and trolleys in handling heavyweights during the recycling procedure minimized the possibility of occupational risk from ergonomic hazards. It was stated that in previous research, a significant risk was assessed on workers who were handling of waste manually within the recycling premises compared to workers who were handling by mechanical aids (Cioca et al., 2018).

Furthermore, staff in all areas was interviewed to list other potential hazards in the working station and consultation of owners for the required information that supportive of the final results. In this case, the unavailability of any detailed health and safety audits and records in all plants was highlighted, as any of these establishments were not eligible for the implementation of relevant OSHMS under Thai laws and regulations based on the small-scale establishment criteria. Also, it was examined that workers do not have the knowledge and skills to successfully identify not only emerging and hidden hazards but also obvious hazards. Under these conditions, hazard identification training for employees is just one example of a proactive response to organizational risk management in support of workplace risk management (Bahn, 2013).

As an outcome of the hazard identification procedure, it was decided to determine and assess the exposure levels and occupational risk of each hazard for every plant. Furthermore, it was concluded that exposure levels at each plant comprise different values due to many factors such as recycling capacity, infrastructure facilities, machinery, process variations, product variation &, etc. Apart from that, it was identified that the machine operators in all the plants were the potential group of

workers subjected to the highest risks compared to other workers due to direct exposure to hazards from machinery.

## **4.2.2 Exposure Assessment**

### **4.2.2.1 Heat stress**

Heat exposure measurements and assessments were carried out among workers in the extrusion process and the MWS for all selected recycling plants. Heat stress indices were used to assess the heat stress which workers exposed at each recycling plant along with the environmental parameters.

#### ***Environmental Parameters***

The results of the environmental parameters were taken at the abdominal level as tabulated in Table 4.1, where it showed that most measured environmental parameters are higher than the standards for indoor thermal comfort conditions. Relative humidity (RH) of all MWSs was above 60% except plant A, where the American Society of Heating, Refrigerating and Air-Conditioning Engineers (ASHRAE) standards for indoor thermal conditions and ventilation defined 60% to 80% RH range as upper limits. Although these limits were often not defined explicitly, the concern for the health issues related to high humidity that might occur under these conditions. Adverse effects that may be caused by the interaction between high humidity environment with pollutants such as formaldehyde under the primary level (Baughman et al., 1996). Also, these results revealed that there is a statistically significant ( $p < 0.05$ ) relationship between environmental parameters and working conditions in individual recycling plants. Variations in extrusion temperature depend on the type of product, recycling capacity, and ventilation of each plant might be reasons for this statistical significance as the climatic conditions assumed to remain identical at all locations during a fixed period of a day within a short period of a particular season.

According to Kjellstrom, Lemke, and Otto (2013), in tropical settings, the indoor temperature is significantly influenced by high ambient temperatures and humidity levels. Also, workers who were exposed to that indoor temperature which combined with heat-generating processes might be subjected to potential health risks



and productivity decrements. Moreover, workers may be incapable to release sufficient sweat to relevant to their metabolic heat generated within the body, and the heat gained from the working environment due to lower evaporative cooling capacity in the hot humid environment compared to in hot dry conditions. Therefore, the tropical hot climate and high humidity in Thailand is a crucial factor in health risk related to heat stress. This kind of result was observed in previous research, where local climatic context and socio-economic factors give higher occupational heat stress and adverse health outcomes within a large national cohort of Thai workers (Tawatsupa, Lim, Kjellstrom, Seubsman, & Sleight, 2010).

*Table 4.1 Environmental parameters and heat stress index of recycling plants*

	Environmental Parameters*	Plant A		Plant B		Plant C		Plant D	
		Mean	SD	Mean	SD	Mean	SD	Mean	SD
Extrusion	Wet bulb (°C)	32.13	0.23	30.67	0.06	30.60	0.10	28.50	0.10
	Dry bulb (°C)	41.13	0.32	38.67	0.12	39.53	0.15	38.70	0.00
	Globe temperature (°C)	45.63	0.15	48.97	0.15	42.37	0.06	39.83	0.15
	Relative Humidity (%)	40%	2.0%	48%	1.0%	50%	0.6%	45%	0.6%
MWS	Wet bulb (°C)	28.23	0.06	28.63	0.15	28.54	0.12	28.39	0.19
	Dry bulb (°C)	35.53	0.12	35.40	0.61	36.92	0.21	36.75	0.12
	Globe temperature (°C)	36.87	0.06	35.57	0.15	38.76	0.09	38.31	0.15
	Relative Humidity (%)	49%	0.01	60%	0.01	64%	0.7%	61%	1.4%

\*Measured at the abdominal level

### *Heat stress index*

Heat stress to which an individual is exposed at extrusion and the MWS was assessed using WBGT empirical indices. Figure 4.13 shows the WBGT indices obtained at all plastic recycling plants. Before the evaluation of this index, CAF values and workload categories for each worker of each recycling plants were determined. All the workers in four recycling plants were dressed in standard cotton or light polyester material cloths without any protective wear. The CAF value of zero was used for standard cotton shirt/pants in the calculations. The heavy workload category was selected for workers at the MWS including the extrusion section of all plants based on observations. Here, most of the workers engaged in multitasking with certain heavy work activities such as shoveling melted plastic and lifting heavyweights. But the work to rest to ratio differ from recycling

plants wisely. This work-rest ratio for the workload category was not mentioned in Thai OSH regulations, wherein ACGIH mentioned about that crucial factor. Accordingly, the TLV and AL values were selected based on the work to rest ratio per hour.

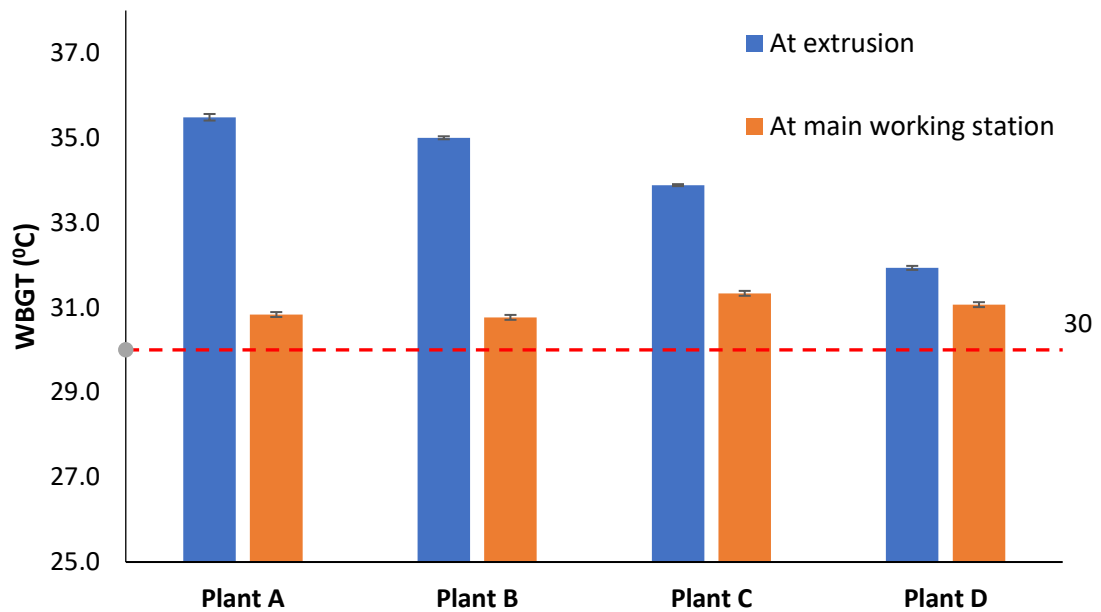

Figure 4.13 Heat stress values ( $^{\circ}\text{C}$ ) at extrusion and MWS of plastic recycling plants

According to Figure 4.13, all the WBGT values at both measurement points exceed the Thai OSH regulation limit of  $30^{\circ}\text{C}$  for the heavy workload category and these results interpret that all the workers within MWSs were exposed to a certain degree of heat stress according to Thai regulations. Also, all the WBGT values at the extrusion process were recorded higher than the MWSs. High heat released from the extruders resulted in high levels of heat stress compared to the MWSs. Moreover, the mean increment of WBGT values at extrusion of all plants was around 14% relative to Thai regulation value, where it was only around a 3% increment at the MWS. Therefore, workers who were engaged in tasks involved with extruder types of machinery in all recycling plants were exposed to higher heat stress levels compared to the other workers in the MWS. However, we were unable to find any other study (any published research work) on health impact by heat stress in the plastic recycling plant in Thailand, nor in other countries. But Langkulsen, Vichit-Vadakan, and Taptagaporn (2010) conducted similar research for occupational heat stress

exposure for indoor workers of a power plant and construction site in Thailand. In this study, no worker was exposed to WBGT higher than 30 °C of Thai regulation limit.

According to the Tukey test, there were significant differences ( $p < 0.05$ ) between WBGT values at the extrusion of all four recycling plants. But there were no significant differences ( $p > 0.05$ ) in between all WBGT values at the MWS of all the recycling plants as related to extrusion. This outcome suggests that heat stress levels rely more on the variation in extrusion temperature which depends on the type of plastic, than working conditions such as ventilation facilities. In this case, WBGT values at extrusion of PP recycling plant (Plant A) was higher than both PE (Plant C and D) plants by more than 1.6 °C and 3.6 °C, because of the higher extrusion temperature in PP recycling compared to PE. According to Kyoko Yamashita et al. (2009), it was reported a difference of 50 °C in extrusion temperature between PP and PE. However, the heat stress levels on Plant C were higher than Plant D by 2°C though both plants consist of similar extrusion process parameters. Here, it was suggested that the inadequate ventilation and high proportion of hot fumes emitted to indoor air due to outdated fume extraction systems were the reasons for this considerable difference.

*Table 4.2 Screening of calculated & measured WBGT values (°C) with ACGIH standards*

	At Extrusion			At the MWS		
	Calculated	ACGIH TLVs	Work-Rest per hour	Measured	ACGIH TLVs	Work-Rest per hour
Plant A	35.5	30	25%-75%	30.9	26	Continuous work
Plant B	35.0	28.5	50%-50%	30.8	26	Continuous work
Plant C	33.9	27.5	75%-25%	31.4	26	Continuous work
Plant D	31.9	27.5	75%-25%	31.1	26	Continuous work

\*Heavy workload

Similar to previous results, all the WBGT values at both inspection points exceeded the recommended TLVs of ACGIH for the heavy workload category, as shown in Table 4.2. It was difficult to precisely determine the percentage of heavy workload workers subjected to particular heat stress, as the workers were engaged in multi-tasking. Different outcomes of occupational heat stress assessment were reported in various types of industries. According to Venugopal, Chinnadurai, Lucas, and Kjellstrom

(2015), 77% of workers who were performed heavy workload exceeded TLVs of ACGIH at both hotter and cooler seasons in India. In another study, 28% of workers employed in multiple processes who were performed mostly moderate workload were at risk of heat stress-related health impairment in automotive industries due to exceeding of TLVs of ACGIH (Ayyappan, Sambandam, Paramasivan, & Balakrishnan, 2009).

Nevertheless, extruder machine operators and workers who were involved in tasks with extruder of all plants have experienced the increment in heat around 5.5 °C above the limits of the regulation based on their work to rest ratios. In contrast to Thai regulations, workers at the MWSs experienced a higher heat increment of 5 °C above the limits of the ACGIH regulation. However, the infrastructure with adequate ventilation of recycling plants which were registered as a factory producing plastic products from waste plastic under type 53 (5) of the Ministry of Industry, Thailand (Plant A and Plant B) was eased the heat transfer phenomenon. As a result, the heat stress values at the MWS were lower than other plants although high heat stress value was recorded at extrusion.

Lastly, many studies stated that exposure to extreme heat conditions is hazardous to health and has been linked with a range of illnesses and premature death. National Oceanic and Atmospheric Administration's National Weather Service (NOAA's NWS), U.S. Department of Commerce, 2009 stated that the heat stress range of 32 °C to 41 °C is categorized as 'Extreme caution' which possible to occur heat disorders for people in high-risk groups such as heatstroke and/or heat exhaustion possible with prolonged exposure. Under this statement, all the extruder operators and workers involved in tasks with extruder might be undergone the above-mentioned health issues at long term exposure.

#### 4.2.2.2 Noise level

Noise levels were measured at a distance from types of machinery at four sections (Shredding, Extrusion, Pelletizing, and Mixer), where machine operators and workers usually operate the machinery and perform their tasks. Figure 4.14 shows the noise levels at shredding, extrusion, and palletization. Here, 100% of all evaluated noise level values were not exceeded the Thai regulation limit of 85 dBA (TWA) for 8-hour work per day. Additionally, all these noise levels were ranged below 75 dBA. In previous research on noise emissions in plastic recycling plants in Brazil, a dissimilar result was recorded mainly for extrusion and shredding processes. Here, the total operation process, with all the equipment in operation the plant noise generation varied from 59.6 to 98.0 dBA, showing that the plastic recycling plant under study generated high noise levels at extrusion and shredding or grinding processes (Ferreira de Campos, 2018).

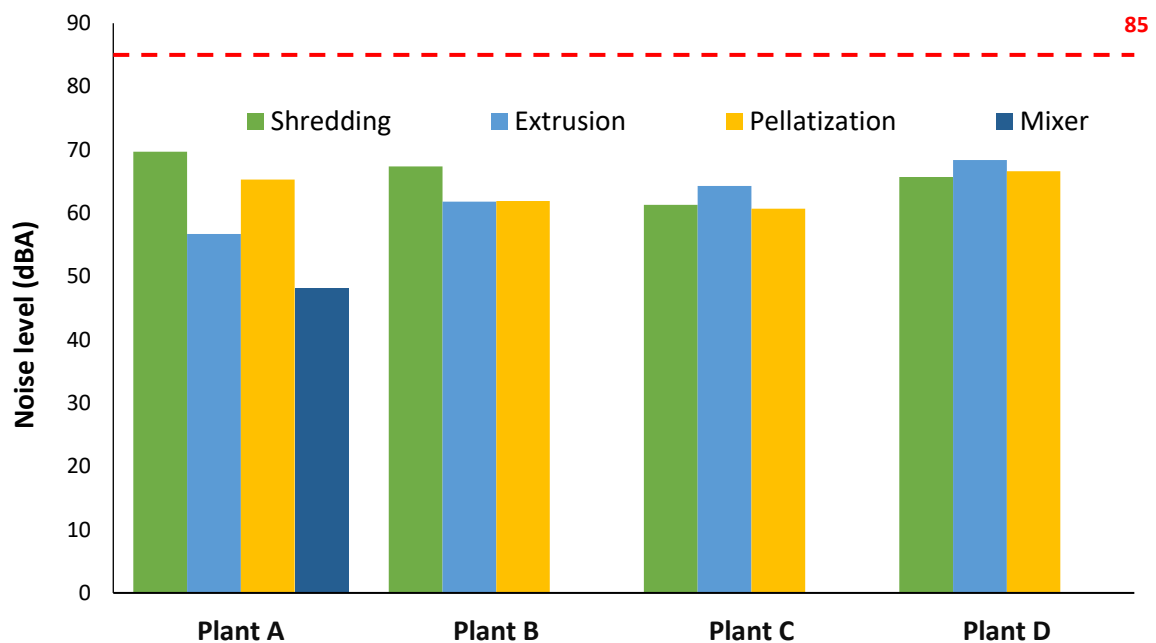

Figure 4.14 Noise levels at different stages of plastic recycling plant

The highest noise levels were determined near to shredder compared to other processes in Plant A and B for the Plant D and C, the extrusion process emitted higher noise levels compared to other processes. However, 100% of all workers in the three sections were not exposed to hazardous noise value of 85 dBA. This outcome of this study

contrasted with other studies conducted on different types of industries which involved processes such as grinding. In a research study conducted on noise exposure assessment of workers in a steel reinforcement mill, 65.56% of the workers of the plant were exposed to noise level superior to 87 dBA of European regulation exposure limit (Meddeb & Tadjine, 2016). Another research conducted by Burns, Sayler, and Neitzel (2019) stated that approximately 15% of noise level exposures exceeded the recommended 85 dBA exposure limit and all of these overexposures were associated with dismantling activities related to e-waste recycling.

#### 4.2.2.3 Illuminance (light)

All the light measurements were performed at four locations which were required adequate lighting for safe operations to identify and avoid occupational accidents. Figure 4.15 shows the levels of light at four selected locations within each plant. Initially, it was observed that most areas of Plant A and B were installed with a single row of individual luminaires for improved illuminance than single light in the middle of the areas which was most common in Plant C and D. This statement was justified by the comparatively higher LUX values of Plant A and B compared to other two plants.

Two separate Thai OSH regulation limits for illuminance was used based on the guidelines given.

- Minimum light intensity for the preliminary step of the industrial process, and product transfer points such as warehouse required to be at least 100 LUX.
- Minimum light intensity for an area of work requiring visual inspection of work, and inspection of a large object such as manual sorting, shredding, and extrusion required to be at least 200 LUX.

According to Figure 4.15, most areas in Plant A that were provided with adequate light levels except extrusion. But Plant B was the only plant that was provided with all the required light levels at extrusion according to Thai standards. Light levels at the MWS of Plant C was lower than 50 LUX. Furthermore, the probability of accidents happening within work premises was high in both Plant C and D due to

inadequate light levels compared to the other two recycling plants which were registered under type 53(5) of the Ministry of Industry.

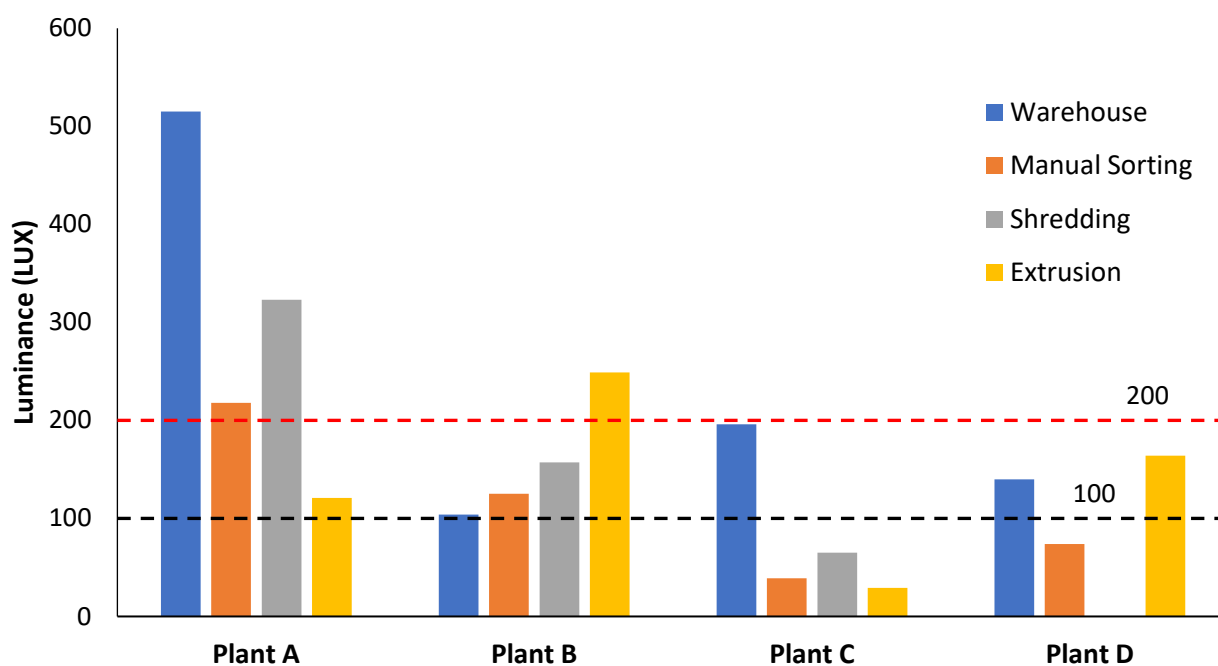

Figure 4.15 Illuminance at different stages of plastic recycling plant

#### 4.2.2.4 Volatile Organic Compounds (VOC's)

Preliminary qualitative studies were conducted based on the site survey and hazard identification outcomes to detect the presence of VOCs in the indoor environment. VOCs such as propane, pentane, hexane, cyclohexane, and styrene were detected in all four selected plastic recycling plants. Furthermore, preliminary quantitative analyses were carried out for the 4 selected VOC species (formaldehyde, acetone, styrene, and hexane). Here, only hexane was detected at a range of around  $1.2\text{mg}/\text{m}^3$ . Based on this outcome, it was decided to increase the sampling time to attain a minimum volume of 3L for each sample in the main VOC analysis procedure along with the NIOSH standard procedure. Also, it was observed as unpleasant smells in all the premises. A research study conducted by Huang et al. (2013) was mentioned that the cause of odor nuisance was proportional to the oxidative compounds generated from the PE and PP lines as it was more than 50% of the total VOCs and these could contribute to the unpleasant smells.

Based on the findings from previous literature, it was decided to expect severe health conditions for the workers such as chronic lung diseases and cancer along with prolonging the exposure of VOCs emitted at extrusion from all recycling plants under observed conditions. Moreover, the workers who were worked alongside extrusion machines (high-risk zone) were identified as high-risk workers to VOC exposure. The following workers were identified and included in the above-mentioned category in each plant separately:

- Plant A: Workers at the mixer, pelletizing, and extruder
- Plant B: Workers at the extruder, pelletizing, and packaging
- Plant C: All the workers at MWS (low ventilation and inefficient fume extraction)
- Plant D: Workers at extrusion and pelletizing

Finally, it was decided to conduct a wide quantitative analysis for a range of VOCs by selecting certain recycling plants. In that case, Plant A and B were selected based on the modern manufacturing processing, adequate facilities, and high final product outcome which were relied on the recognition at the Ministry of the Industry under factory type 53(5).

### **4.2.3 Risk Evaluation and Estimation**

#### **4.2.3.1 Risk matrix method**

Risk evaluation was performed by considering the multiplication product between probability level and severity level of the event affecting workers to obtain a risk matrix. Accordingly, Table 4.3 shows all severity and probability levels which were evaluated at the checklist method of hazard identification. It was highlighted that probability levels of all hazards attained the maximum value of four except the shredding. The continuous occurrence of these hazards within the working premises was the main reason for that value, as these hazards were related to types of machinery that were continuously involved in the recycling process. Only the shredder has not functioned continuously on a daily basis.

Besides, most severity levels were evaluated based on the exposure assessment values of each hazard along with definitions given in the literature for those exposure



levels. In this case, the unavailability of records about occupational accidents and hazards was the main reason to proceed with the above mention method for probability level evaluation. Lack of this type of information was common in small scale industries. As mentioned earlier, the severity levels for noise and heat were evaluated from exposure levels with the defined severity levels in literature for particular exposure levels. However, exposure concentrations of VOC were not analyzed in the preliminary stage of this research and it was evaluated as a prediction based on previous research findings and qualitative analysis.

*Table 4.3 Determined severity and probability levels for the identified hazards*

	Operation	Plant A		Plant B		Plant C		Plant D	
		Severity	Probability	Severity	Probability	Severity	Probability	Severity	Probability
Noise	Shredding	0	2	0	2	0	2	0	2
	Mixer	0	4	0	NA	0	NA	0	NA
	Extrusion	0	4	0	4	0	4	0	4
	Palletization	0	4	0	4	0	4	0	4
Heat	Extrusion	2	4	2	4	2	4	2	4
VOC	Extrusion	3	4	3	4	3	4	3	4

NA-Not applicable due to the absence of machinery

Table 4.4 shows the evaluated risk levels from the above-determined severity and probability levels. Here, the risk due to exposure of VOCs at all four plants was higher among all other hazards. The unacceptable risk was evaluated as a prediction for all workers who were exposed to ranges of VOCs that emitted from the extruder. Moreover, the noise levels from any machinery were not led to any risk, as the noise levels from all machinery were below 75 dBA. Evaluated risk level from heat stress at the extrusion process was also rated as higher risk. The unavailability of safety and health records for heat stress illnesses like heat stroke and heat exhaustion was a huge setback for the risk evaluation. Furthermore, the lack of protective measures for identified hazards was crucial and worsens the situation even more at recycling plants, A and B were rated as an acceptable risk due to a low probability level. Additionally, workers at the MWS experienced an acceptable risk although the heat stress levels were above the Thai regulation limit due to less defined severity. Lastly, some difficulties arose in interpreting these outcomes on exposure levels and associated health effects. The main reason is given that it was not assured that each hazard preceded adverse

effects as expected. Indeed, this could be avoided with the direct measurement of health outcomes, but that procedure was not carried out in this study under the limitations. Due to these reasons, it was required to classify this risk estimation as preliminary in nature.

*Table 4.4 Evaluated risk levels for all identified hazards in plastic recycling plants*

Operation/Machine/Location	Plant A			Plant B			Plant C			Plant D		
	Noise	Heat	VOC	Noise	Heat	VOC	Noise	Heat	VOC	Noise	Heat	VOC
Shredding	-			-			-			-		
Mixer	-											
Extrusion	-	8	12	-	8	12	-	8	12	-	8	12
Palletization	-			-			-			-		
MWS		4			4			4			4	

Acceptable Risk    
  High Risk    
  Unacceptable risk    
  Not evaluated

*Table 4.5 Risk level guideline ("Regulation of Department of Industrial Works. Re: Criteria for hazard identification, risk assessment, and establishment of risk management plan B.E. 2543 ", 2000)*

Risk Level	Multiplication product	Meaning
1	1-2	Small risk
2	3-6	Acceptable risk, requiring revision of control measure
3	7-11	High risk, requiring action to reduce risk
4	12-16	Unacceptable risk, requiring a cease in operation and immediate corrective action to reduce risk

### 4.3 VOC emissions from PSW extrusion process

In the entire plastic mechanical recycling process, VOCs were only released from the melting and extrusion process within the extruder machine (Patel & Xanthos, 1995). Hence, the VOC released from selected two recycling plants during the extrusion were studied.

#### 4.3.1 Initial step in quantitative analysis of VOC analysis

Due to certain limitations of this study, a total of 11 kinds of VOCs were selected from the 4 groups (hydrocarbons, aromatic hydrocarbons, ketones, and formaldehyde) were analyzed and quantified according to NIOSH standards in the initial step. This procedure was carried out to confirm the availability of those chemical compounds for the next stage of analysis (Table 4.6). This selection was carried based on three factors:

- Results of the preliminary qualitative analysis: Hexane, cyclopentane
- The abundance of particular species in the similar literature: Hexane, Acetone, Styrene, Xylene isomers, Toluene
- Importance as a critical compound in human health risk: Carcinogenicity of benzene, ethylbenzene, styrene, and formaldehyde

However, for the discussion of all the outcomes of the emissions from extrusion, were compared mainly between two plastic recycling practices (PP and PE), because these two factories registered under the Thai ministry of industries exhibited identical features in most aspects of the occupational environment and process parameters, other than recycling plastic variety or practice. Accordingly, this selection was allowed to compare the differences in the VOC emissions from PP and PE plastic types by limiting the other factors that affect the indoor VOC concentrations to a greater extend. Previously in a preliminary study, Plant A and B were classified into three groups as PP, PE, and PP+PE. But Plant B only operates one production line at a time by mainly focusing on PP, due to the low market demand for the final products under global pandemic conditions. However, the extracted samples of toluene and hexane from PP+PE taken in the preliminary study was analyzed in this stage of VOC analysis only for future reference.

According to Table 4.6, only hexane and toluene concentrations were detected under the initial stage of VOC analysis. Concentrations of other VOC species were below

the limit of detection (LOD) of the NIOSH method. Based on the above results, samples of toluene and hexane were subjected to further analysis as the next stage.

*Table 4.6 Indoor air concentrations of selected volatile organic compounds*

Group of VOC	VOC species	Sampling method	Analytical method	Concentration (ppm)			
				PP (Plant A)	PE (Plant A)	PE (Plant B)	PE+PP (Plant B)
Hydrocarbon	Hexane	Sorbent tube	GC/FID method	Detected	Detected	Detected	Detected
	Cyclopentane	Sorbent tube	GC/FID method	<0.01	<0.01	<0.01	-
Ketones	Acetone	Sorbent tube	GC/FID method	<0.01	<0.01	<0.01	-
Aromatic hydrocarbon	Benzene	Sorbent tube	GC/FID method	<0.02	<0.02	<0.02	-
	Ethylbenzene	Sorbent tube	GC/FID method	<0.01	<0.01	<0.01	-
	Toluene	Sorbent tube	GC/FID method	Detected	Detected	Detected	Detected
	o-xylene	Sorbent tube	GC/FID method	<0.01	<0.01	<0.01	-
	m-xylene	Sorbent tube	GC/FID method	<0.01	<0.01	<0.01	-
	p-xylene	Sorbent tube	GC/FID method	<0.01	<0.01	<0.01	-
	Styrene	Sorbent tube	GC/FID method	<0.01	<0.01	<0.01	-
Formaldehyde	Formaldehyde	Sorbent tube	GC/FID method	<0.01	<0.01	<0.01	-

#### 4.3.2 Quantitative analysis of toluene and hexane

Based on the results obtained in the earlier step, only hexane and toluene were selected for further analysis to quantify the indoor air concentrations. For each chemical compound, samples from four-time slots of sampling at each recycling practice were analyzed under the NIOSH procedure (Annex B). Here, the variations of VOC concentrations were not statistically analyzed under the limitations of this study.

Figure 4.16 shows the calculated mean hexane and toluene concentration exposed to the workers at each recycling practices from two recycling plants. Only the concentration of VOCs of PP recycling practice of Plant B was analyzed. It is required to mention that PE production was non functioned as usual during the second sampling stage due to the global pandemic situation.

Out of the indoor mean VOC concentrations of all plastic recycling practices of both recycling plants, hexane was the compounds with the highest mean values of 627  $\mu\text{g}/\text{m}^3$ -1174  $\mu\text{g}/\text{m}^3$ . In previous similar research studies, the hexane concentration was recorded around 23  $\mu\text{g}/\text{m}^3$  to 36  $\mu\text{g}/\text{m}^3$  (He et al., 2015). These elevated levels in this study might be due to the higher polymeric composition of hexane bases additives in the raw material used, as other factors such as fume extraction at extruder were in favor of this study. Hexabromocyclohexane which is used as a common flame retard in industrial plastic manufacturing might be released hexane in polymer degradation from its cyclohexane ring by certain interactions with other compounds. It was shown in previous research that hexane was the most abundant VOC released in thermal degradation of LDPE plastic which used cyclohexane as solvent (Karaduman, Şimşek, Çetin Koçak, & Bilgesü, 2002). Difficulty in elaborate these variations was mainly because of any research study not intensely recognized about the chemical reactions taken place within the plastic extrusion process.

However, toluene concentrations were ranged from 292  $\mu\text{g}/\text{m}^3$  to 451  $\mu\text{g}/\text{m}^3$ . These values were also higher than previously determined values of 114  $\mu\text{g}/\text{m}^3$  314  $\mu\text{g}/\text{m}^3$  on indoor VOC concentrations at both PP and PE recycling plants in similar research studies (He et al., 2015; Huang et al., 2013). But these values were not shown a considerable deviation compared to hexane. Additives such as butylated hydroxytoluene (BHT) which are using as common antioxidant in PP and PE that would also evaporate toluene from reactions with other compounds.

Comparatively, the mean concentration of both toluene and hexane from the extrusion of PP was higher than all the mean concentrations of VOCs from the extrusion of PE at Plant A and B. Moreover, the mean hexane concentrations from all recycling practices were showed an 87%-160% range of increase than mean toluene

concentration from all plastic recycling practices. However, TVOCs released from PP extrusion of Plant A was highest among all other recycling practices.

In the comparison between emissions from PP and PE of Plant A was more reliable as all other factors affect for indoor VOC level were the same. Here, all the obtained mean concentrations of hexane, toluene, and TVOCs from PP extrusion at Plant A higher than the PE at the same plant. According to Huang et al. (2013), higher mean toluene concentrations were detected at PP recycling practice compared to PE of the same plant with lower percentage variation than the results of this study. In contrast to these results, the higher toluene and hexane concentrations were recorded at PE extrusion than PP in another study (He et al., 2015).

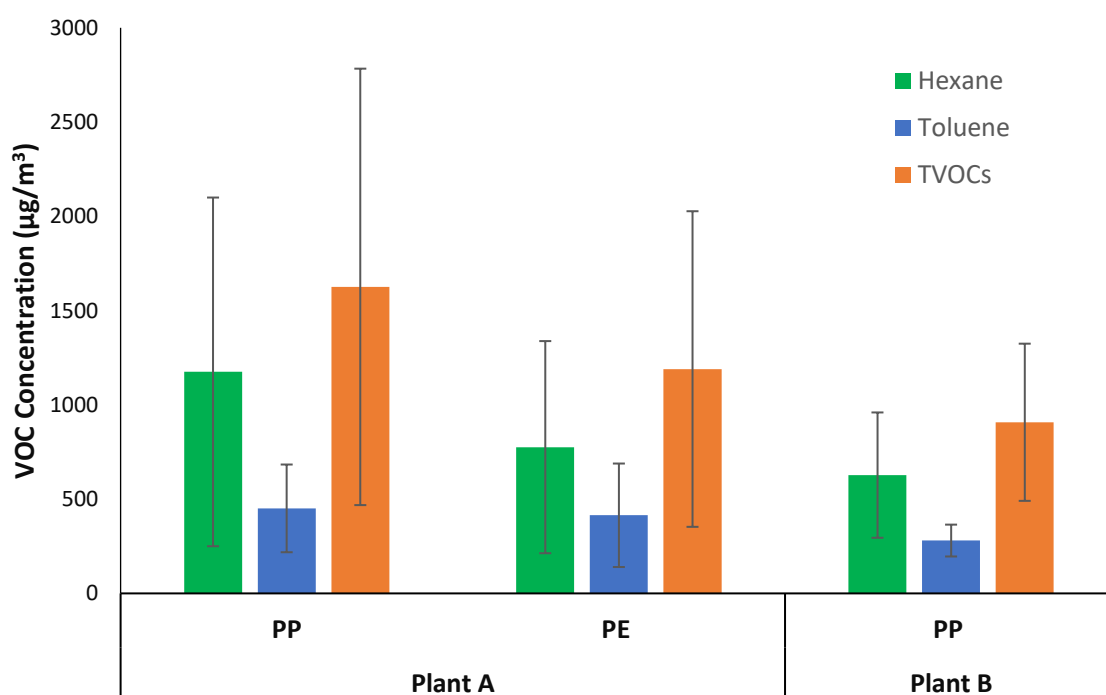

*Figure 4.16 Mean concentration of hexane, toluene, and TVOCs exposed to workers within 8h working shift in PP and PE recycling practices during extrusion processes of plastic recycling plants*

While higher extrusion temperatures of PP recycling relative to PE could be a reason for the higher concentration of hexane and toluene in PP extrusion of Plant A compared to PE extrusion in the same plant due to the increase of polymeric degradations at higher temperatures. In that case, a previous study stated that the larger

quantities of VOCs (or TVOCs) were emitted at higher temperatures compared to lower temperatures (Kyoko Yamashita et al., 2009). Moreover, it was believed that thermo-oxidative and thermo-mechanical degradation of PP occurred through the chain scission of the macromolecules, leading to a decrease in the molecular weight by a series of radical reactions such as oxidation, fragmentation, and disproportionation (Canevarolo, 2000). Furthermore, the chain branching and the crosslinking took place simultaneously in PE with the chain scission, resulting in the formation of more nonvolatile macromolecules (Camacho & Karlsson, 2002). Therefore, a higher probability of formation of compounds such as hexane and toluene is with the extrusion process of PP compared to PE.

However, there was no significant difference ( $p > 0.05$ ) between the type of plastic and kind of VOC (either toluene or hexane), as the VOC measurements were fluctuated greatly due to samples taken within 8 hours per day at 4 different occasions (time slots). Changes that take place within the indoor microenvironment and extrusion process at that period of 8 hours were crucial for this type of outcome. Previous research studies stated that the indoor VOC concentrations were sensitive to the ventilation rates of the building which was effective in controlling the exposure of chemicals to workers (Parthasarathy, Chan, Fisk, & McKone, 2012). Accordingly, Gough (2017) demonstrated that the building's natural ventilation was affected by the meteorological conditions of a day. In this case. There was a high probability of variations in indoor VOC concentrations as both recycling facilities have an adequate circulation of air due to the building designs. Moreover, the recycling plants were installed with certain industrial fans which might be a reason for unusual variations of VOC concentrations, where it removed VOCs along with the airflow. Also, few studies reported the impact of VOC concentrations based on the ventilation rate in commercial buildings. In a previous study, measured VOC concentrations in a big box retail store increased by 50% when some air handling units in the building were turned off for load handling within a day (Rhodes, Nirlo, Srebric, & Siegel, 2011). In contrast to that, Zuraimi et al. (2006) reported that high levels of VOC concentrations in office buildings in Singapore for the period of shutting down ventilation systems. Besides, extrusion retention time and interactions of chemicals along with the time and temperature may result in the

quantity of VOC emissions. There is a huge necessity for examining this fluctuation of VOC concentrations based on factors such as ventilation, process parameters, and behavior of VOCs in the indoor microenvironment as future studies.

#### 4.4 Occupational health risk assessment of VOC exposure

##### 4.4.1 Occupational exposure limits

Acute and chronic risks to the workers in the plastic recycling plants might be possible with high levels of VOC emissions at the extrusion process. Hence, the OEL of emitted VOCs in each recycling facility was assessed according to the guidelines of ACGIH standards. Accordingly, TLV-TWA of toluene and hexane of ACGIH standards used to evaluate the occupational exposure effects in this study. The adjusted concentration of a particular VOC based on the PP and PE recycling percentages of each plant was used to estimate the occupational exposure indices  $E_i$  for both the detected VOCs during the extrusion process in the recycling plants were given in Figure 4.17.

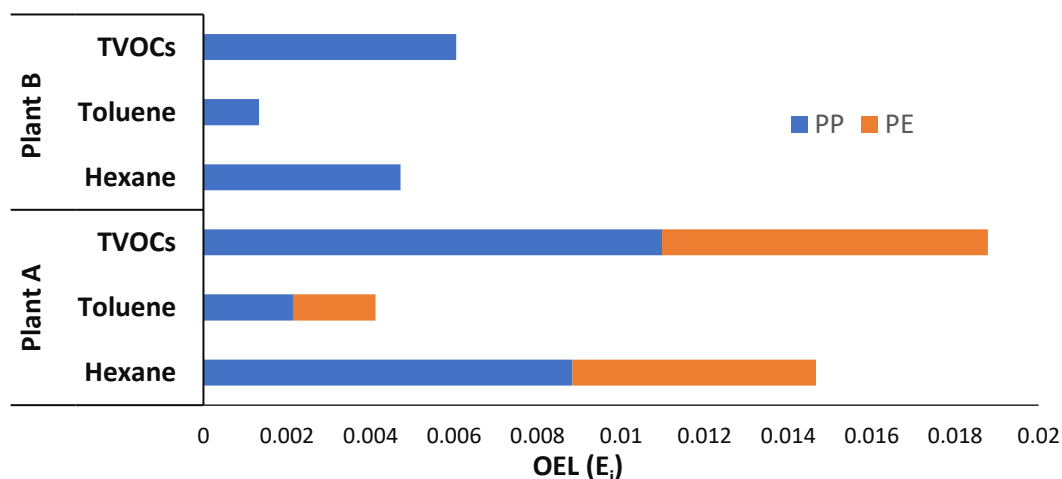

Figure 4.17 The occupational exposure indexes ( $E_i$ ) assessment of hexane, toluene, and TVOCs exposed to workers in PP and PE recycling practices (Real-time scenario) during extrusion processes of plastic recycling plants

It was found that  $E_i$  values for TVOCs (cumulative risk) were less than 1.0 in all PP and PE recycling practices of both plants, indicating that workers in these two workshops might not suffer from potential health risks from the emitted VOCs due to higher threshold limit values are allowable for toluene and hexane in ACGIH



guidelines. However, hexane indicated the highest mean  $E_i$  in both recycling plants, respectively. In this case, similar results were recorded in a previous research study with  $E_i$  value lower than 1.0 for both Toluene and hexane at both PP and PE recycling plants (He et al., 2015). Although the  $E_i$  values of both plants were below 1.0, their potential health impacts could not be completely ignored because they are not fine lines between safe and dangerous exposures, nor are they a relative index of toxicology. The TLVs are no quantitative estimates of risk at different exposure levels or by different routes of exposure. While ACGIH does not believe that TLVs should be adopted as standards without an analysis of other factors necessary to make appropriate risk management decisions (Statement of Position Regarding the TLVs and BEIs, adopted by the ACGIH Board of Directors on March 1, 2002).

#### **4.4.2 Non-cancer risk**

The non-cancer risk was expressed in terms of the HQ and HI. Accordingly, HQ is defined as the ratio of the estimated exposure concentration to a chronic reference concentration. Besides, the ratio of chronic daily intake to the chronic reference dose for inhalation defines the HI of workers. Potential exposure to a particular VOC level to avoid any adverse effects that could be expected was provided by both the non-cancer risk characterization in terms of HQ. But the HI was estimated for the sum of hazard quotients for a VOC that could affect the same target organ or system for a specified exposure duration.

##### **4.4.2.1 Hazard quotient (HQ)**

Based on the indoor mean concentrations, calculated non-cancer hazard quotients (HQ) of toluene and hexane for the workers at PSW recycling plants were presented in Figure 4.18.

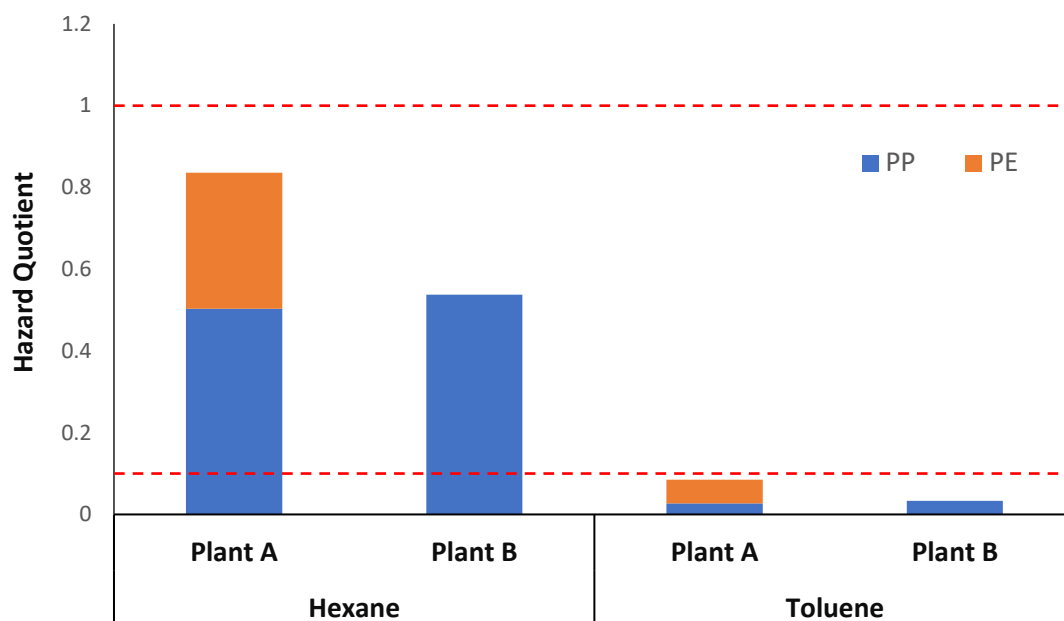
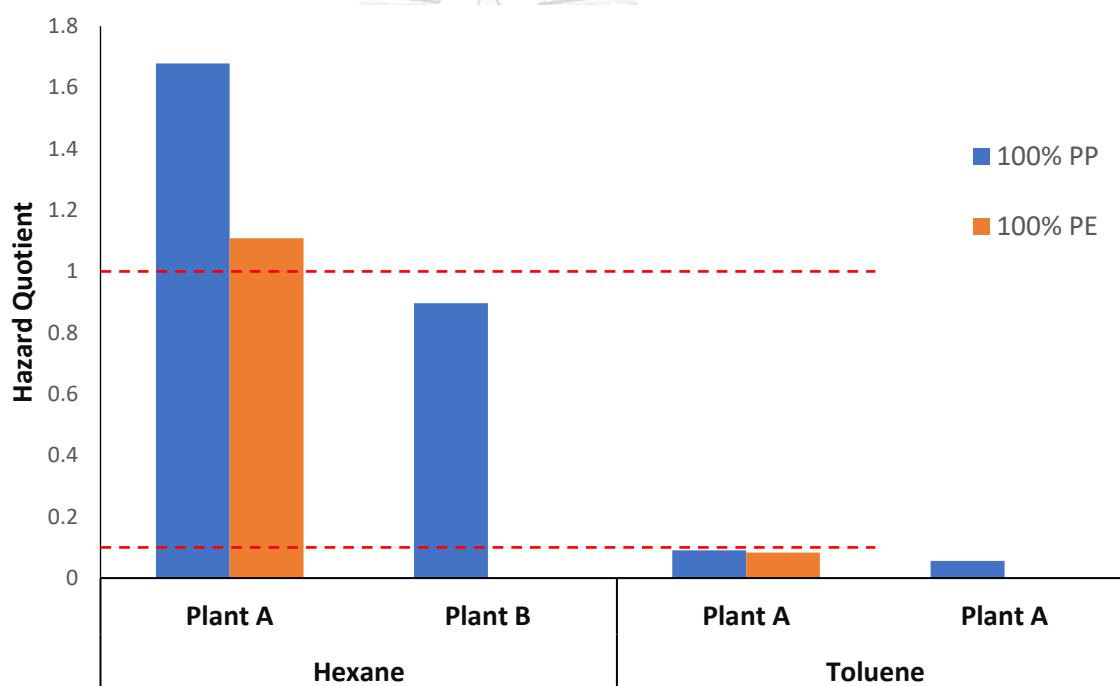

Figure 4.18 Non-cancer hazard quotients of hexane and toluene exposed to workers in PP and PE recycling practices (Real-time scenario) during extrusion processes of plastic recycling plants

The high HQ values were investigated for hexane in both recycling plants due to the higher indoor mean hexane concentrations recorded for both PP and PE extrusions. Also, the RfC of hexane ( $0.7\text{mg}/\text{m}^3$ ) was lower than RfC of toluene ( $5\text{mg}/\text{m}^3$ ) by 7 times magnitude. So, a higher concentration of toluene compared to hexane is acceptable on continuous inhalation exposure to the human population (including sensitive subgroups) without an appreciable risk of deleterious effects during a lifetime. Moreover, HQ associated with PP were above 0.1 by contributing 62% of the overall non-cancer risk from hexane in Plant A, though it occupied 30% of recycling capacity. Also, the HQ of hexane at Plant B were exceeded 0.1 solely. In the real-time scenario, none of the plastic recycling practices were exceeded HI above 1.0, while indicating that adverse non-cancer risk might not be affected to the workers by hexane or toluene emitted from extrusion. As for the toluene, with HQ values less than 0.1, it was possible to declare that the non-cancer risks of toluene were improbable to affect the workers. Nevertheless, it was considered that the compounds still posed potential risks to the workers' health with the values between 0.1 and 1 (Ramírez, Cuadras, Rovira, Borrull, & Marcé, 2012). Also, research conducted by Shan et al. (2017) on the petrochemical industry reported that the average HQs were less than 1 for most of

the hydrocarbons but the HQs of n-hexane were more than 1, which can indicate that workers' exposure to this compound needs more attention.

While Figure 4.19 shows the scenario for comparison between HQ between PP and PE recycling practices with 100% recycling capacity for each type of plastic (either PP or PE) in both recycling plants separately. Here, if the Plant A recycle both PP and PE separately at 100% recycling capacity, hazard quotients were exceeded 1.0 by a considerable margin for indoor hexane concentrations. However, the HQ from the indoor hexane concentration of Plant B did not exceed 1.0. Moreover, the HQs from indoor toluene concentrations of both plants did not surpass even the limit of 0.1.



*Figure 4.19 Non-cancer hazard quotients of hexane and toluene exposed to workers in PP and PE recycling practices (comparison scenario) during extrusion processes of plastic recycling plants*

Overall, under the current conditions, hexane released from Plant A might be posed a non-cancer risk to workers who were at high risk of category in hazard identification at both the criteria. Further investigation is required for Plant B as the only portion of VOCs released was analyzed under this study. However, HQs of toluene were below 0.1, where it could declare that indoor toluene concentration might not be able to affect worker's health.

Based on the above results, workers at Plant A have the probability to experience both sensory and motor dysfunctions associated with the neurological effects which could be manifest as negative outcomes from exposure of hexane exposure. Initially, there might symmetric sensory numbness of the hands and feet, with loss of pain, touch, and heat sensation. If this condition gets worse than the initial stage, motor weakness of the toes and fingers is often experienced by patients, weakness of the muscles of the arms and legs may also be observed. These onset symptoms of this condition may not be shown for several months from exposure, which it normally takes above a year after the beginning of the exposure. Complete recovery is still possible for workers who show only initial symptoms, but a certain degree of the sensorimotor deficit will be often retain for severely exposed individuals (Mutti et al., 1984).

#### **4.4.2.2 Hazard Index (HI)**

In the hazard identification, the total numbers of 11 workers from both plants were categorized as workers at higher risk due to the probability of exposure to high levels of VOCs. Also, the indoor concentrations were measured by focusing mainly on this group of workers. Accordingly, samplings were carried out in the high-risk zone, where they have executed their tasks. Out of those 11 workers, 6 workers were from Plant A and the remaining 5 from Plant B. Here, the chronic non-cancer risk was estimated for a period of recruitment age to the retirement at approximately 60 years of age.

HI of each detected VOC were shown in Figure 4.20 only for the comparative analysis of the estimated value among the kinds of VOC. Here the highest HI values were observed for indoor hexane concentrations of Plant A. Although a similar trend was shown in HQ, all the evaluated HI of workers in Plant A was below 1.0. Here, PP contributed more percentage on hazard index due to high mean concentrations of hexane at PP recycling practice than PE in Plant A. Moreover, low inhalation RfD value and higher concentrations of hexane were the main reasons for higher HIs of hexane compared to the toluene of both recycling plants. However, none of the individual HIs for a compound were exceeded 1.0, it was possible to declare that the non-cancer risks were unlikely to affect the workers in the real-time situation in each compound wise. But HIs values of hexane estimated from both recycling plants exceeded the limit of

0.1. Still, it was considered that these VOCs posed potential health risks to the workers with the HI values between 0.1 and 1 (He et al., 2015). But HIs values of toluene were below 0.1 by ensuring that the workers were exposed to toluene concentrations which consider to not affect the health of workers.

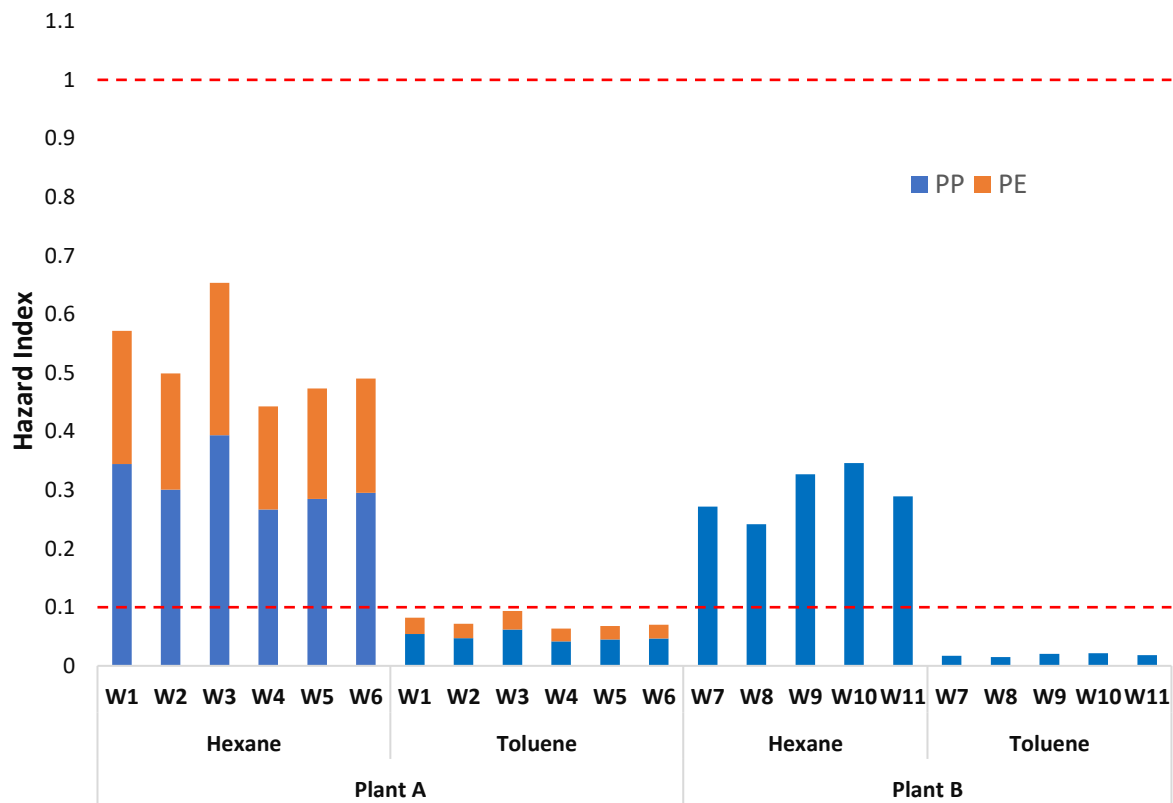

Figure 4.20 Estimated non-cancer hazard index of hexane and toluene separately that exposed to workers in PP and PE recycling practices (real-time situation) during extrusion processes of plastic recycling plants

However, several research studies were conducted on occupational health risk by evaluation of hazard indices and hazard quotients in different kinds of industries except in plastic recycling facilities (Nabizadeh et al., 2020; Shanb et al., 2017). Besides, He et al. (2015) assessed the non-cancer risk of nearby residents from PP and PE plastic recycling facility for each VOC, where it recorded that toluene and benzene released from PE extrusion resulted in HIs above 0.1. This outcome may be an indication of the certain high levels of VOCs even could affect nearby residents and establishments.

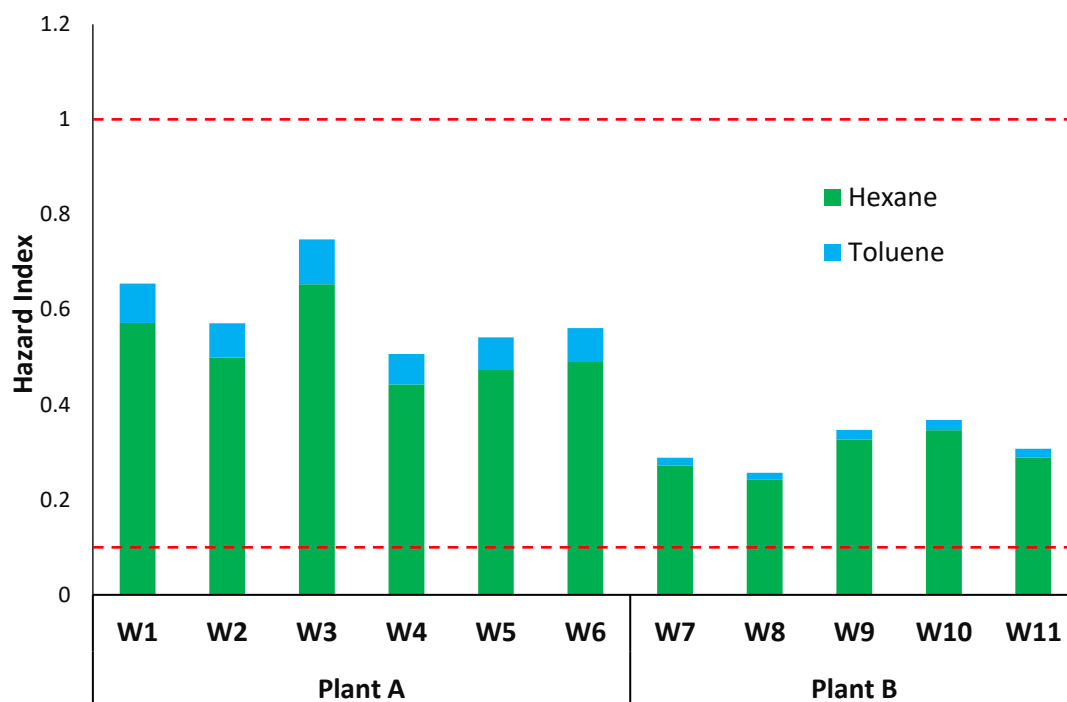

Figure 4.21 Non-cancer hazard index from both hexane and toluene exposed to workers in PP and PE recycling practices (real-time situation) during extrusion processes of plastic recycling plants

According to Figure 4.21, HIs of hexane and toluene at real-time situations relevant to each recycling plant were given based on the fact that both compounds could affect the same organ or system in the human body. In toxicology studies, it was confirmed that neurological effects may mainly occur due to exposure of toluene and hexane (Soni V., 2018). Still, HIs of both plants were not exceeded 1.0 limit while representing a low possibility of risk to the workers. But, the results of Plant A could not be compared with Plant B, due to the unavailability of emission concentration related to PE recycling practice. Still, HIs values of both recycling plants from hexane and toluene estimated exceeded the limit of 0.1. Accordingly, it was considered that these VOCs posed potential health risks to the workers with the HI values between 0.1 and 1. Under this statement, the non-cancer risk from VOCs emitted in plastic recycling plants according to HI could not be ignored.

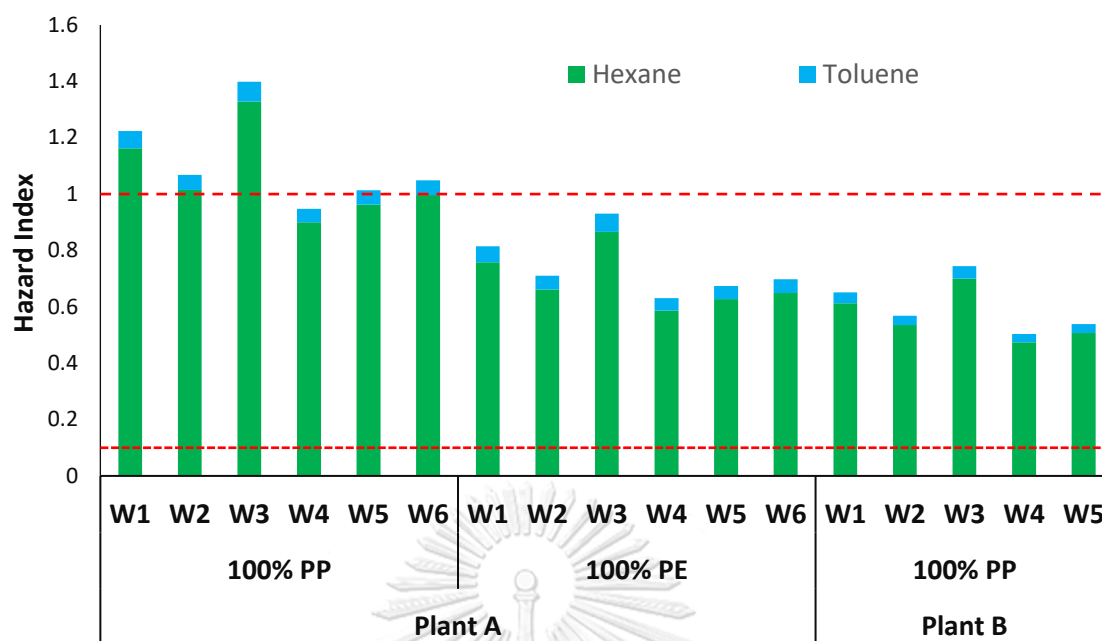

Figure 4.22 Non-cancer hazard index from both hexane and toluene exposed to workers in PP and PE recycling practices (comparison scenario) during extrusion processes of plastic recycling plants

Nevertheless, Fig. 4.22 shows the scenario for comparison between HIs between PP and PE with 100% recycling capacity of either PP or PE for both recycling in both recycling plants separately. Here, the hazard index was exceeded 1.0 only for the majority of workers in Plant A if it recycles only PP (100% recycling capacity). Also, HIs of PP were comparatively higher than PE with a high possibility of non-cancer risk. However, all HIs of Plant A with 100% PE and Plant B with 100% PP recycling capacity did not exceed 1.0. The trend shown here was similar to HQ under the comparison scenario. Based on the results of the comparison scenario, the recycling of both types of plastic in a certain recycling facility (especially Plant A) might be reduced the risk to workers as PE extrusion gives lower estimated risk values than PP extrusion.

#### 4.4.3 Cancer Risk

There was no cancer risk able to estimate due to undetected of carcinogenic compounds such as benzene, styrene, and ethylbenzene. However, the detected toluene and hexane are not considered or categorized as carcinogenic due to the lack of

toxicological data. Nevertheless, this outcome was not agreed with the previous literature (He et al., 2015).

#### 4.4.4 Uncertainty analysis

Varieties of uncertainties exist in the procedure of health risk assessment from exposure to VOCs. Here, uncertainties in measurement, uncertainties in values assigned to population exposure variables, and the uncertainties introduced in risk characterization due to the day-to-day, place-to-place variations in concentrations were mainly considered (Kim, Harrad, & Harrison, 2002).

Unavailability of consistent terminology for defined risks and difficulty in understanding the fundamentals of the mathematical estimation process required to state under this uncertainty criteria. Estimation of the mathematical components of the risk is a basic procedure followed in risk analysis and characterization. In the case studies, most of the quantification of risk estimate must be made from the suitable assumptions depend on the context. In the analysis process and obtaining measurement, a certain degree of uncertainty must arise however the procedure followed was highly precise and avoid numerous errors. Correction for these types of uncertainty is not reliable.

The values assigned exposure variables for a population comprises uncertainties also affect final risk assessment outcomes. Under the current risk estimations, the exact cancer risk from exposure to individual VOC cannot be determined. Here, uncertainties arise in dose-response data used in quantitative cancer risk analysis along with the low-dose exposure scenarios and the absence of a proper understanding of the mode of action, (USEPA). Under the quantitative risk estimation, it was recommended a range of estimates comprising equal scientific acceptability. The range estimates are maximum likelihood values and were derived from observable dose responses using a linear extrapolation model to estimate low environmental exposure risks. The use of a linear model is a default public health-protective approach and an argument both for and against recognizing linear relationships at low doses and non-threshold or threshold modes of action on exposure to individual VOCs (USEPA, 1998). Therefore, the true risk could be either higher or lower.



In this study, the exposure levels of selected VOCs were based on short-term monitoring in indoor environments for an 8h. This method that followed disregards potential daily variations that could be a noticeable influence on exposures of VOCs on workers over a prolonged period (Kim et al., 2002).

#### **4.5 The possible factors that affect the overall outcome of the study**

The main highlighted outcome of this study was undetected of most VOC species in contrast to previous researches conducted on VOC emissions at PP and PE plastic recycling plants in other countries. To ensure this issue, it was required to carry out sampling for the second time. But the samples were unable to obtain as planned previously due to unavoidable situations from the global pandemic. The main reason was that the production capacities and operating hours of the recycling plants were changed along with their market demand which was impacted by this pandemic. However, it was necessary to discuss the possible reasons which may affect the indoor VOC concentrations as below. Here, findings from previous studies were used to compare the result of this study (He et al., 2015; Huang et al., 2013).

##### **I. Different sampling and analytical methods**

The differences in Limit Defining Parameters of such as detection limits (LOD), minimum injection volume, storage stability, and precision among different VOC sampling, extraction, and analysis methods were used by the above-mentioned researches could be contributed vastly for this dissimilarity. Here, higher LOD values of the NIOSH methods than those methods were highlighted. In that case, some concentration of VOC species which were detected in those works of literature may be unable to detect under the NIOSH method. Accordingly, there might be a possibility of undetected of lower concentration of certain VOCs.

However, the NIOSH method is highly suited for the scope of this research as it was focused on occupational health rather than characterizing pollutants. Moreover, Kumar and Viden (2007) stated that sorbents encountered with lower collection efficiency and analyte recovery, which may be avoided in the canister sampling method. Therefore, detecting different concentrations of varieties VOCs in He et al. (2015) could be explained using this fact.

## II. Contribution of the fume extraction system and ventilation factors

In many developing countries, VOCs are emitted directly into the outside environment without any adequate treatment and/or removed along with ventilation due to primitive and unsophisticated facilities utilized in the extruder process and extruder machinery (He et al., 2015). Fumes emitted at extrusion were directly exposed to the indoor air without adequate treatment or extraction in all of the recycling facilities in those research studies. Accordingly, All of the plastic waste recycling plants in Huang et al. (2013), only used filter to treat the melting fumes, and this could not efficiently eliminate the gaseous compounds and malodor. But, in the case of this study, both plants were equipped with well-maintained fume extraction systems which minimized the emission of greater volumes of fume with VOCs to the indoor air. Therefore, VOC concentrations could be varied in comparison with the literature.

Nevertheless, airtightness due to inadequate ventilation from inappropriate building design (few window openings) and absence of mechanical ventilation strongly influenced the industrial and urban indoor air VOC concentration (Hernandez et al., 2020; Jia, Batterman, & Godwin, 2008; Mečiarová, Vilčeková, Burdová, & Kiselák, 2017; Rösch, Kohajda, Röder, Bergen, & Schlink, 2014). Besides that, the indoor VOC level is influenced by the combined effects of temperature and humidity along with ventilation rates (C. Zhou et al., 2017). Therefore, it was evident that industrial setups with different ventilation may affect indoor VOC concentration.

## III. Variations in Polymeric composition with additives

Additives used as plasticizers, UV stabilizers, and antioxidants were considered as common types that comprise special functions according to the requirements. So, these additives might lead to remarkable variations in VOCs (Hahladakis, Velis, Weber, Iacovidou, & Purnell, 2018). However, there was no mention of the nature of PP and PE waste plastic used in literature for the comparison of industrial based waste plastic used in this study. Furthermore, as an example, cyclopentane which is a plasticizer was detected in the qualitative analysis was not reported in any relevant literature. Also, according to Huang et al. (2013), the high amount of aromatic hydrocarbons and oxidative compounds might be not only from polymer degradation and additives but also from the volatile contaminants, such as printer ink.

#### IV. Process parameters and factors

Several studies indicated that the variety and quantity of VOCs emitted depended on the material used and the operating parameters where VOCs has undergone polymer degradation at the operating temperature of PP and PE extrusion (Adams et al., 1999; Barlow et al., 1996; Xiang, Mitra, Xanthos, & Dey, 2002). Here, result data illustrated the pollution profile, and the cumulative VOC emissions strongly influenced by the processing parameters such as temperature, heating rate, and residence time. Moreover, it was mentioned that the higher operating temperature was increased the emission of VOCs at extrusion. According to Pospíšil et al. (2003), various VOCs might still be formed within extruder and released into the atmospheric environment at this melting temperature around 150–300 °C which is much lower than the pyrolysis in mechanical recycling due to the factors such as aging, long thermal exposure, intrinsic sensitivity. Also, indoor VOC concentration could depend on the volume of fume released based on the recycling capacity of the factory. Hence, the comparison of the results of this study with literature may not be justified to a certain extent.

#### **4.6 Recommendations: Possible safety measures for risk management**

The hazard identification and risk evaluation suggested undeniable health risks to most workers in the small-scale plastic recycling plants in Thailand. It is required to ensure to implement suitable safety measures by targeting the emission sources, propagating pathways, and individual receptors. These implementations were highly recommended for the hazards due to heat and VOCs, as noise exposure levels not exceeded Thai regulation limits. In that case, hazards are mainly associated with the performance of the extruder machine and its outcomes.

##### **4.6.1 Heat hazard**

Factory owners and management should reduce workplace heat stress by implementing engineering and administrative controls. Here, minimizing the exposure of heat to workers at the point of the source by engineering controls was concluded as the most practical and effective approach than other measures that were recommended.

#### 4.6.1.1 Engineering controls

Engineering controls such as facilitating mechanical aids, heat insulation for extruder machines, and adequate ventilation, or cooling are considered as possible measures with suitable modifications for these small-scale recycling plants in the economic context. Out of these measures, modification of heat extruders with a suitable heat insulation cover and operating at efficient process parameters were highly recommended as those measures able to mitigate heat at the point of source.

- I. Modification and installation of heat insulation barrel jacket: The heat transmitted to the outside from the extruder barrel could be able to minimize by a greater extent from installing a heat insulation barrel jacket. Different insulation materials are normally used in the present world for specific industrial requirements. The selection of insulation material should be based on initial cost, effectiveness, durability, and machinery requirement. In this case, a cheap and durable material with a high R-value (insulation rating) such as a fiberglass blanket with an outer layer of aluminum foil is highly recommended (Figure 4.23).

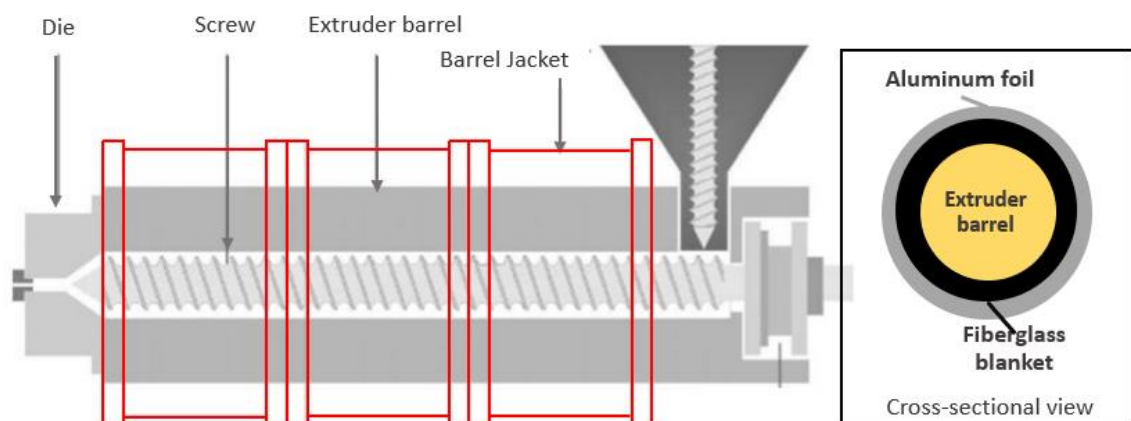

Figure 4.23 Schematic diagram of an extruder with the installation of heat insulation cover (or blanket)

- II. Controlling the performance of the heater: In extruders, in build function of controlling the heat produce by the heater is required to inspect to maintain the minimum temperature required to melt both PE and PE. Extra heating is not even economically beneficial to management as it consumes high electricity.

Fluctuating at heating could be fixed by assigning fixed performance parameters to the heater according to the type of plastic.

- III. Mechanical aids: Usage of primary level automated screw feeder to feed the sorted plastic flakes to the extruder's hopper will reduce a considerable time on the exposure of extruder operators on hazardous heat stress levels. Most plants in this research not used screw feeders except Plant A, where this necessity is required to consider.
- IV. Control the indoor temperature and facilitating ventilation:
  - Industrial fans were provided by factory management to all the plants at each processing line of the extrusion to palletizing. But it is recommended to install separate industrial fans on the areas where extruder operators are carrying out their tasks.
  - Modification of the building structure of the recycling plant C is highly suggested to improve ventilation and also material handling practices. Because the buildings with low height and minimum openings to the outside (windows and exit ways) of Plant C were not recognized as suitable for the thermal comfort of workers.
  - Installation of updated fume extraction systems for both Plant C and Plant D to control the indoor temperature as these fumes were released out at a temperature above 150 °C.

#### **4.6.1.2 Administrative controls**

- I. The exposure length of workers at high-risk to hot environments require to regulate by issuing workplace guidance to workers, especially extruder operators that specify the duration of work in under the risk. Accordingly, providing periodic rest breaks by switching the task of operating extruder with other workers. Also, rest facilities with air-conditioning might be very appropriate for them.

- II. Prevent dehydration by providing cool water in the workplace, mainly at the MWS, and encourage workers to drink it frequently in small amounts before, during (where possible), and also at the end of working. A high rate of sweating is normal in this hot and humid environment to regulate body temperature, but this loss of vital water must be replaced.
- III. New and young employees must give a training program to explain to them about the risks of heat stress associated with their work, the nature of the symptoms to concern out for, safe working practices and guidance, and emergency procedures.
- IV. Identify employees who are more susceptible to heat stress because of an illness, condition, or medication that may contribute to the early onset of heat stress, e.g. those with heart conditions. You may need advice from an occupational health professional.

#### **4.6.2 Chemical hazards (VOC)**

It was highly recommended to the management of both plants to take corrective actions by implementing mainly engineering controls to minimize the exposure of workers to the VOC by limiting the leakage or quantity of emission from the extruder machine at the source.

##### **4.6.2.1 Engineering controls**

Engineering controls such as suitable modifications for the extrusion system and controlling the process parameters in these small-scale recycling plants in a way of economically feasible.

- I. Prevent the leakages from the extruder machine: It was observed that the extruder machine of Plant B consisted of a lot of leakages, also at the same time those leakage points were pointed to the fume extraction opening. Still, there were places in the machinery where the leakage could avoid.
- II. Increase the performance efficiency of the fume extraction system: Though both recycling plants installed with fume extraction systems, the efficiency of those systems were doubtful in extracting or sucking the fumes from the openings

of the extruder, because it was observed that a lot of fumes were escaped from the fume extraction opening tunnels. Installation of an adequate pump for the suction of air depending on the volume of the fumes required to handle is a solution for this. Placement of fume extraction system inlets as shown in Fig 2.4 will be highly effective, as a major portion of fumes emitted within the barrel of the extruder. Also, the placement of inlets closer as possible to the extruder minimize the chance of escaping more fumes.

- III. Control of process parameters: It was observed that the temperature reading of the thermocouples in the machine was fluctuating with time. This is because of the high retention of molten plastic within the extruder barrel. The screw rotation speed is required to maintain throughout the process while regulating checking the temperature reading of the machine to adjustments in the heater.
- IV. Facilitate the ventilation: As previously mentioned under engineering controls for heat hazards.

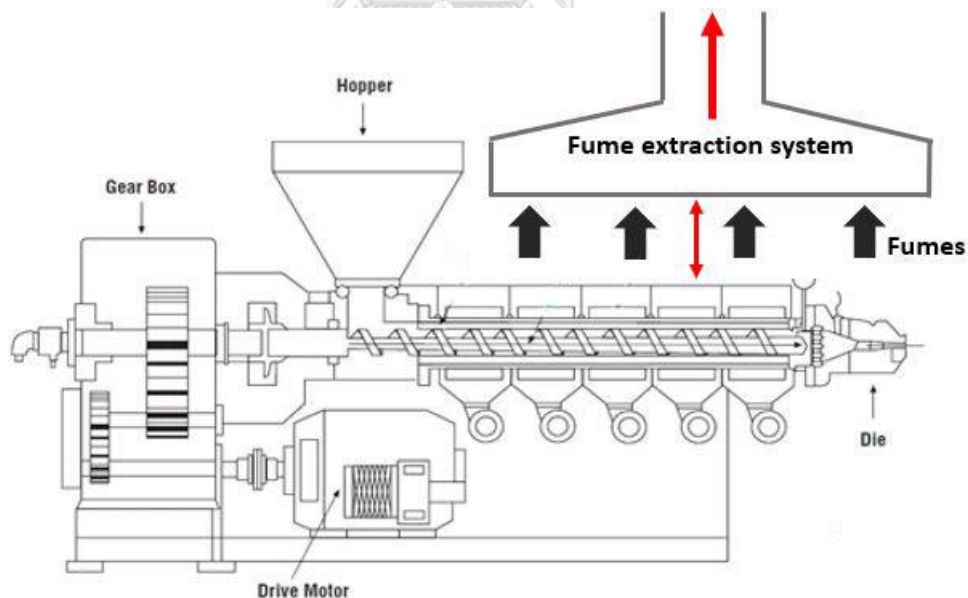

Figure 4.24 Schematic diagram of an extruder for appropriate placement of the fume extraction system's inlets

#### 4.6.3 Noise hazard (only for future reference)

Poor maintenance of types of machinery in certain recycling plants, especially Plant C and D may lead to some possibilities in noise hazards in the future. Also, the

occupational safety and health administration (OSHA) of the USA issued control measures for noise level control in plastic recycling facilities. Therefore, factory management should not neglect the hazard from noise completely. These engineering controls could be useful for the management in future reference.

#### 4.6.3.1 Engineering controls

Different controls have to implement based on the type of machinery which might be responsible for a higher level of noise emission in the future. However, the recommendations given below do not force the management to replace the current machinery with a new model in the market.

- I. Shredder: It is the machinery which has the highest potential to emit hazardous noise levels compares to other types of machinery.

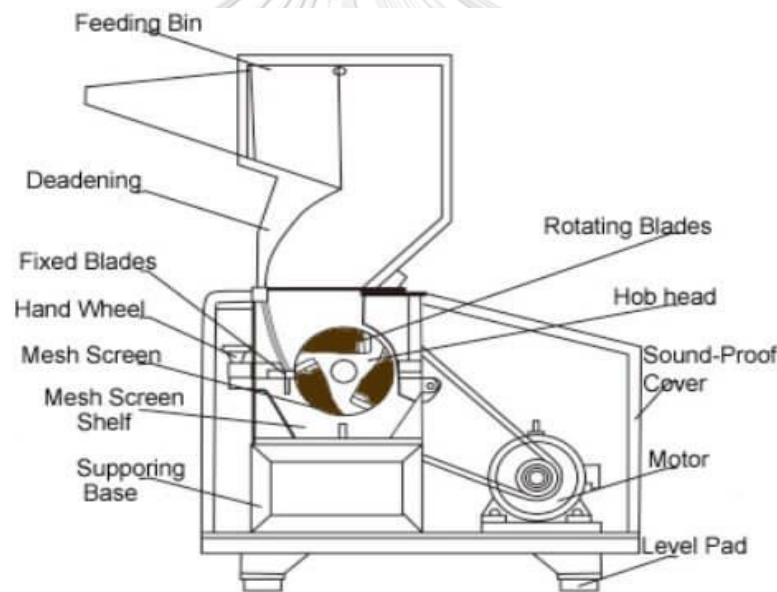

*Figure 4.25 Schematic diagram of a shredder*

- Locate this machine in separate rooms or buildings or enclose it with soundproof casing. Also, the usage of a feed conveyor to remove the operator from a higher noise area around the shredder as an alternative along with this recommendation.
- Replacement of standard rotating shredder blades for PP and PE with upgraded shredder blades optimized for better grinding of the plastic



waste into fine-grained particles. Also, several research studies were conducted to design highly efficient blades for plastic shredding (Vinothkumar, 2018).

- Reduce rotor speed as the high rotor speed emits high noise. It is required to make sure the reduced motor speed may not affect the quality of the shredded flakes.

I. Extruder: Drive motor and individual vibration of compartments of this large machinery emits high noise to surrounding

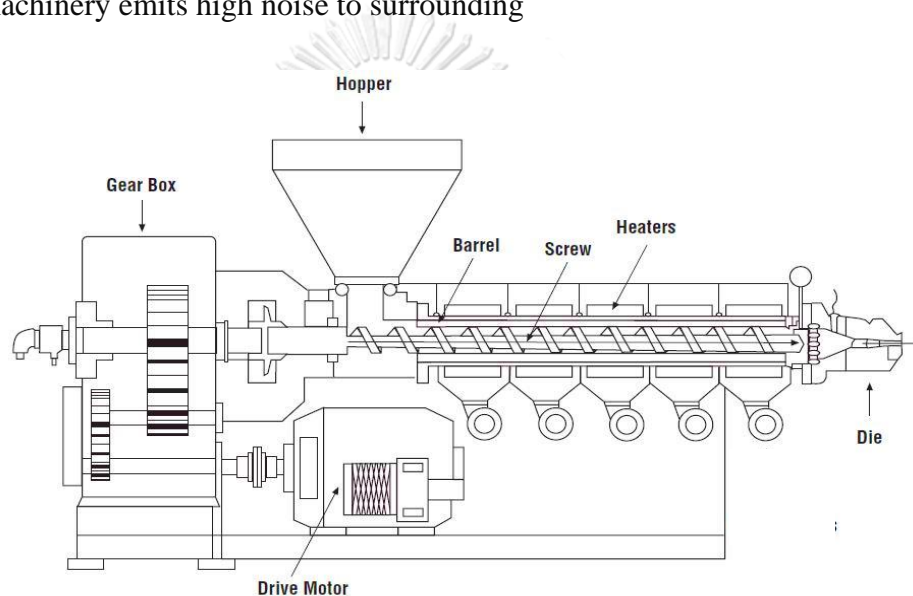

Figure 4.26 Schematic diagram of an extruder

CHULALONGKORN UNIVERSITY

- Enclose drive motor with the soundproof cover for most of the plants except plant A. In other plants drive motors were not equipped with proper coverings.
- Fixing of silencers to drive motor air intakes and exhausts could initiate as another modification to reduce the noise of motors.
- Mount pumps and motors on anti-vibration mounts. These mounts could equip with spring levelers.
- Incorporate flexible hoses in pipelines in the cooling system.

II. Pelletizer: High noise is generated by the impact of each blade against the strands and the alternate compression and expansion of air as the moving knives pass the fixed bed knife-edge.

- Replace the cutter blade with a helical blade, which would pass progressively across the bed knife-edge cutting one strand at a time rather than all simultaneously, would further reduce noise levels.

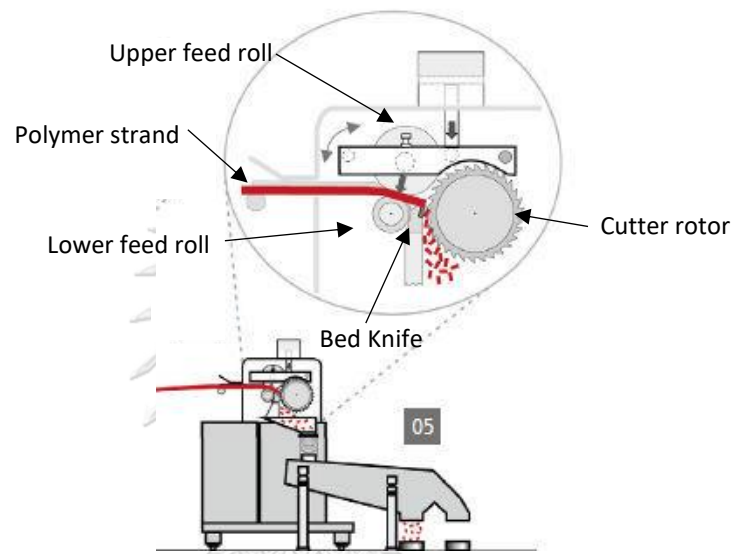

Figure 4.27 Schematic diagram of a pelletizer

- Reduce the speed of rotation by increasing the number of blades fixed into the cutting head. Additional benefits of the helical cutter were found to be reduced wear and a reduced need to sharpen blades.
- Adapt the anti-vibration treatment with the cutting head installed on a base which isolates from the rest of the machine

## CHAPTER 5

### CONCLUSIONS

The mechanical recycling approach which is commonly practiced in small scale plastic recycling plants in Thailand includes a series of mechanically and thermally driven stages that may lead to various occupational hazards including physical, chemical, etc. Due to the unavailability of proper OHSMS without good manufacturing practices and safety protocols may lead to high occupational risk within the indoor microenvironment. Moreover, it was found that VOCs emitted from recycling plants cause an immense health risk. In this research, all occupational hazards were identified, and health risks associated with VOCs emitted at extrusion were defined to formulate risk control and management procedure for small scale plastic recycling plants in Thailand.

According to the result of the preliminary study, physical hazards (heat and noise) and chemical hazards from volatile organic compounds (VOCs) were the main two groups of hazards identified in the hazard identification of four selected small-scale plastic recycling plants of PP and PE in Thailand. Measured and assessed exposure levels of heat and light were unable to meet the OSH regulations limits of Thailand that are assigned by the Ministry of Industries and Ministry of labor.

Heat stress exposure assessment results showed that WBGT values at both extrusion and MWS exceeded the Thai OSH regulation limit of 30 °C for the heavy workload category and these results interpreted that all the workers within MWSs were exposed to a certain degree of heat stress according to Thai regulations. Similar to previous results, all the WBGT values at both inspection points exceeded the recommended TLVs of ACGIH for the heavy workload category. The significant difference ( $p < 0.05$ ) between WBGT values at the extrusion of all four recycling plants revealed that the heat stress levels rely more on the variation in extrusion temperature which depends on the type of plastic or recycling practice, than working conditions such as changes in ventilation. In that case, WBGT values at extrusion of PP recycling practice was higher than both PE recycling practices by more than 1.6 °C, because of the higher extrusion temperature in PP

recycling compared to PE. Therefore, under the tropical hot climate and high humidity conditions in Thailand, all the extruder operators and workers involved in tasks along with the extruder might be undergone heatstroke and/or heat exhaustion with prolonged exposure.

Furthermore, all evaluated noise level values were not exceeded the Thai regulation limit of 85 dBA (TWA) for 8-hour work per day. Apart from that, only most areas in Plant A that were provided with adequate light levels except extrusion. Due to low light levels below recommended Thai regulations, the probability of accidents happening within work premises was high in both Plant C and D compared to the other two plants. Besides, varieties of VOCs were detected in the extrusion process of both PP and PE. Here, the workers who were performed tasks alongside with extrusion were categorized as workers at high risk to VOC exposure. In the risk evaluation matrix, risk due to exposure of VOCs at all four plants was higher among all other hazards. The unacceptable risk was evaluated as a prediction for all workers who were exposed to ranges of VOCs that emitted from the extruder. Moreover, the evaluated risk level from heat stress at the extrusion process of all plants was rated as higher risk. The unavailability of safety and health records for heat stress illnesses like heat stroke and heat exhaustion was a huge setback for the risk evaluation.

In VOC analysis, only hexane and toluene were detected in the indoor air of selected two plants out of all the 11 species of VOCs analyzed. This analyzed the mean concentration of hexane and toluene exposed to workers ranged from 627  $\mu\text{g}/\text{m}^3$ -1174  $\mu\text{g}/\text{m}^3$  and 292  $\mu\text{g}/\text{m}^3$  to 451  $\mu\text{g}/\text{m}^3$  respectively. Comparatively, the VOC concentration of both toluene and hexane from PP plastic recycling practice was higher than the PE plastic recycling practice at the same recycling plant, although other parameters that affect indoor VOC concentrations could be considered as similar. However, there was no significant difference ( $p>0.05$ ) between the type of plastic and kind of VOC due to high fluctuations in the readings taken within 8 hours, where changes that take place within the indoor microenvironment and extrusion process at that period might be crucial for this type of outcome. Also, further studies with alternative VOC sampling and analysis procedures required to ensure the presence of undetected low-level

concentrations ( $<0.01$ ppm) of VOC species for the characterization of emission profile other than focusing on occupational safety which was already fulfilled in this study.

OEL values of all the recycling practices were far below 1.0 as the TWA values of toluene and hexane were high in magnitude compared to detect concentrations. Due to the higher mean concentrations of hexane exposed to workers in PP recycling practices, the non-cancer risk characterizations were higher compared to PE recycling practices of the same plant. Accordingly, with the HQ between 0.1 to 1.0 for hexane at PP and PE recycling practices, a non-cancer risk might be still possible to the workers in those facilities at the current recycling percentages of PP and PE. As for the toluene, with HQ values less than 0.1, it was possible to declare that the non-cancer risks of toluene were unlikely to affect the workers. In contrast to this, the HQ values of hexane for Plant A were exceeded 1.0, while indicating a potential of non-cancer risk for workers. Nevertheless, a non-cancer risk might be posed to the workers from both hexane and toluene, if the recycling plants A only recycle PP, as HQs were obtained above 1.0.

For HI, all the values for the workers at high risk were below 1.0 under the current recycling capacity of PP and PE at each plant. Individual HIs of either hexane or toluene were below by indicating non-cancer risk unlikely to affect the workers. Still, there might be a potential for non-cancer risk only for hexane as all the HI values exceeded 0.1. Moreover, all HIs of hexane and toluene of both plants exceed the 0.1, while keeping it below 1.0. Nevertheless, it was considered that the compounds still posed potential risks to the workers' health with the values between 0.1 and 1. But, a non-cancer risk might be posed to the workers if the recycling plants only recycle PP, as HI were obtained above 1.0.

Overall, the occupational environment of plastic recycling plants that are registered under the plastic waste recycling category of the Thai Ministry of Industry (Plant A and B) sustains a proper status compared to the other two plants which are not registered under that category. Accordingly, these registered factories already have taken certain measures to mitigate the risk of potential hazards by maintaining adequate working environments with the initial implements such as updated fume extraction

systems, appropriate building infrastructure, proper lightning arrangements, and adequate working space. Furthermore, the risk from emitted VOCs was not adverse as expected because many VOCs were undetected which may pose adverse effects than toluene and hexane from the analysis which is specified for occupational exposure. Still, it is required that the management of factories registered under the Ministry of Industry to ensure the further safety of the workers from heat hazards and characterized non-cancer risks from VOCs by implementing recommended safety measures.

Finally, the management of recycling plants that were not registered under the Ministry of Industry should be focused more on the relevant safety implementations to minimize all identified risks. In all types of recycling plants, the workers assigned at the processing line from the extrusion to the pelletizing were at higher risk compared to other workers, especially extruder. These groups of workers were at higher risk from VOCs and heat compared to other hazards.

### **Limitations**

- Only 2 recycling practices for the analysis of VOCs considered due limitations such as accessibility, factory status, and global pandemic situation.
- The only 11 kinds of VOCs was selected due to limitations in the funding of the project.
- The number of samples taken to analyze the variation of VOC concentrations within different periods of the day was limited based on the above-mentioned difficulties faced in this study.
- No direct measurements of health effects from each identified hazard were taken into consideration due to the limited time and scope of the study.

### **Future studies**

- Pollution characteristics and profiles of VOCs have to formulate for all the VOCs emitted in the extrusion in SSEs in Thailand by selecting a sampling and analysis method with a low LOD than the NIOSH method for understanding the extrusion process of PE and PP plastic recycling.
- Long term exposure of VOC should be analyzed to reduce the uncertainties in risk assessment and precise risk characterizations

- The variations of VOCs concentration along with the time due to other factors which affect such as ventilation and meteorological conditions also require to analyze for further understanding of fate and transport of VOCs.
- Required to take direct measurement of health outcomes from heat and VOCs from workers to ensure the health effects in detail.
- As a holistic method along with QRA, the human health impact of workers in a plastic recycling plant could assess from an indoor VOC exposure via LCIA model characterization
- It is necessary to expand the scope of HRA by including the health risk for nearby residents from VOCs emitted from the plastic recycling plant. Suitable air quality modeling and/or quantitative VOC analysis for ambient or outdoor air could be utilized for this purpose
- The relationship between the indoor and outdoor concentration of VOCs emitted from extruder required to study for the discussion of the fate and transportation of VOCs within the plastic recycle premises.

## REFERENCES

- (ISO), T. I. O. f. S. (2009). ISO 9612. Acoustics – Determination of Occupational Noise Exposure – Engineering Method. In.
- Achilias, D. S., Roupakias, C., Megalokonomos, P., Lappas, A. A., & Antonakou, E. V. (2007). Chemical recycling of plastic wastes made from polyethylene (LDPE and HDPE) and polypropylene (PP). *Journal of Hazardous Materials*, 149(3), 536-542. doi:<https://doi.org/10.1016/j.jhazmat.2007.06.076>
- Adams, K., Bankston, J., Barlow, A., Holdren, M. W., Meyer, J., & Marchesani, V. J. (1999). Development of Emission Factors for Polypropylene Processing. *J Air Waste Manag Assoc*, 49(1), 49-56. doi:10.1080/10473289.1999.10463782
- Al-Salem, S. M., Lettieri, P., & Baeyens, J. (2009). Recycling and recovery routes of plastic solid waste (PSW): A review. *Waste Management*, 29(10), 2625-2643. doi:<https://doi.org/10.1016/j.wasman.2009.06.004>
- Alli, B. O. (2008). *Fundamental principles of occupational health and safety*  
Geneva: ILO: International Labour Office.
- Araki, A., Eitaki, Y., Kawai, T., Kanazawa, A., Takeda, M., & Kishi, R. (2009). Diffusive sampling and measurement of microbial volatile organic compounds in indoor air. *Indoor air*, 19, 421-432. doi:10.1111/j.1600-0668.2009.00606.x
- Arocena, P., & Núñez, I. (2010). An empirical analysis of the effectiveness of occupational health and safety management systems in SMEs. *International Small Business Journal*, 28(4), 398-419. doi:10.1177/0266242610363521
- Assessment of light from work.* Retrieved from <http://envocc.ddc.moph.go.th/uploads/Menu/rayong/light.pdf>
- Barlow, A., Contos, D. A., Holdren, M. W., Garrison, P. J., Harris, L. R., & Janke, B. (1996). Development of Emission Factors for Polyethylene Processing. *J Air Waste Manag Assoc*, 46(6), 569-580. doi:10.1080/10473289.1996.10467493
- Buchdahl, R., Willems, C. D., Vander, M., & Babiker, A. (2000). Associations between ambient ozone, hydrocarbons, and childhood wheezy episodes: a prospective observational study in south east London. *Occupational and Environmental Medicine*, 57(2), 86. doi:10.1136/oem.57.2.86
- Camacho, W., & Karlsson, S. (2002). Assessment of thermal and thermo-oxidative stability of multi-extruded recycled PP, HDPE and a blend thereof. *Polymer Degradation and Stability*, 78(2), 385-391. doi:[https://doi.org/10.1016/S0141-3910\(02\)00192-1](https://doi.org/10.1016/S0141-3910(02)00192-1)
- Canevarolo, S. V. (2000). Chain scission distribution function for polypropylene degradation during multiple extrusions. *Polymer Degradation and Stability*, 70(1), 71-76. doi:[https://doi.org/10.1016/S0141-3910\(00\)00090-2](https://doi.org/10.1016/S0141-3910(00)00090-2)
- Champoux, D., & Brun, J.-P. (2003). Occupational health and safety management in small size enterprises: an overview of the situation and avenues for intervention and research. *Safety Science*, 41(4), 301-318. doi:[https://doi.org/10.1016/S0925-7535\(02\)00043-7](https://doi.org/10.1016/S0925-7535(02)00043-7)
- Chang, E. E., Wei Chi, W., Li-Xuan, Z., & Chiang, H.-L. (2010). Health risk assessment of exposure to selected volatile organic compounds emitted from an integrated iron and steel plant. *Inhalation toxicology*, 22 Suppl 2, 117-125. doi:10.3109/08958378.2010.507636



- Chira, B., Taweep, C., & Praj-Ya, S. (2018). Material flows analysis of plastic in Thailand. *Thermal Science*, 22(6 Part A), 10. Retrieved from <https://doi.org/10.2298/TSCI160525005B>
- Cioca, L.-I., Ferronato, N., Viotti, P., Magaril, E., Ragazzi, M., Torretta, V., & Rada, E. (2018). Risk Assessment in a Materials Recycling Facility: Perspectives for Reducing Operational Issues. *Resources*, 7, 85. doi:10.3390/resources7040085
- Colman Lerner, J. E., Sanchez, E. Y., Sambeth, J. E., & Porta, A. A. (2012). Characterization and health risk assessment of VOCs in occupational environments in Buenos Aires, Argentina. *Atmospheric Environment*, 55, 440-447. doi:<https://doi.org/10.1016/j.atmosenv.2012.03.041>
- Delfino, R. J., Gong, H., Linn, W. S., Pellizzari, E. D., & Hu, Y. (2003). Asthma symptoms in Hispanic children and daily ambient exposures to toxic and criteria air pollutants. *Environmental Health Perspectives*, 111(4), 647-656. doi:10.1289/ehp.5992
- Delfino, R. J., Staimer, N., Tjoa, T., Arhami, M., Polidori, A., Gillen, D. L., . . . Sioutas, C. (2010). Associations of primary and secondary organic aerosols with airway and systemic inflammation in an elderly panel cohort. *Epidemiology (Cambridge, Mass.)*, 21(6), 892-902. doi:10.1097/EDE.0b013e3181f20e6c
- Denisov, E. (2018). Noise at a workplace: Permissible noise levels, risk assessment and hearing loss prediction. *Health Risk Analysis*, 13-23. doi:10.21668/HEALTH.RISK/2018.3.02.ENG
- Duangduan, Y., & Cheevaporn, V. (2008). Characterization and Health Risk Assessment of Volatile Organic Compounds in Gas Service Station Workers. *EnvironmentAsia*, 1.
- Elo, K., Karlsson, J., Lydebrant, K., & Sundin, E. (2009). *Automation of Plastic Recycling – A case study*.
- Fernández, M. D., Quintana, S., Chavarría, N., & Ballesteros, J. A. (2009). Noise exposure of workers of the construction sector. *Applied Acoustics*, 70(5), 753-760. doi:<https://doi.org/10.1016/j.apacoust.2008.07.014>
- Geyer, R., Jambeck, J. R., & Law, K. L. (2017). Production, use, and fate of all plastics ever made. *Science Advances*, 3(7), e1700782. doi:10.1126/sciadv.1700782
- Gough, H. (2017). *Effects of meteorological conditions on building natural ventilation in idealised urban settings*.
- Guo, H., Lee, S. C., Chan, L. Y., & Li, W. M. (2004). Risk assessment of exposure to volatile organic compounds in different indoor environments. *Environmental Research*, 94(1), 57-66. doi:[https://doi.org/10.1016/S0013-9351\(03\)00035-5](https://doi.org/10.1016/S0013-9351(03)00035-5)
- Hahladakis, J. N., Velis, C. A., Weber, R., Iacovidou, E., & Purnell, P. (2018). An overview of chemical additives present in plastics: Migration, release, fate and environmental impact during their use, disposal and recycling. *Journal of Hazardous Materials*, 344, 179-199. doi:<https://doi.org/10.1016/j.jhazmat.2017.10.014>
- He, Z., Li, G., Chen, J., Huang, Y., An, T., & Zhang, C. (2015). Pollution characteristics and health risk assessment of volatile organic compounds emitted from different plastic solid waste recycling workshops. *Environment International*, 77, 85-94. doi:<https://doi.org/10.1016/j.envint.2015.01.004>
- Heat Stress and Strain: TLV® Physical Agents 7th Edition Documentation* (2017). (7th ed.): American Conference of Governmental Industrial Hygienists (ACGIH).

- Hernandez, G., Wallis, S. L., Graves, I., Narain, S., Birchmore, R., & Berry, T.-A. (2020). The effect of ventilation on volatile organic compounds produced by new furnishings in residential buildings. *Atmospheric Environment: X*, 6, 100069. doi:<https://doi.org/10.1016/j.aeaoa.2020.100069>
- Hinsken, H., Moss, S., Pauquet, J.-R., & Zweifel, H. (1991). Degradation of polyolefins during melt processing. *Polymer Degradation and Stability*, 34(1), 279-293. doi:[https://doi.org/10.1016/0141-3910\(91\)90123-9](https://doi.org/10.1016/0141-3910(91)90123-9)
- Huang, D.-Y., Zhou, S.-G., Hong, W., Feng, W.-F., & Tao, L. (2013). Pollution characteristics of volatile organic compounds, polycyclic aromatic hydrocarbons and phthalate esters emitted from plastic wastes recycling granulation plants in Xingtian Town, South China. *Atmospheric Environment*, 71, 327-334. doi:<https://doi.org/10.1016/j.atmosenv.2013.02.011>
- Ignatyev, I. A., Thielemans, W., & Vander Beke, B. (2014). Recycling of Polymers: A Review. *ChemSusChem*, 7(6), 1579-1593. doi:10.1002/cssc.201300898
- International Labour Organization. (2016). Retrieved from <https://www.ilo.org/>
- Isangedighi, I., David, G., & Obot, O. (2018). Plastic Waste in the Aquatic Environment: Impacts and Management. 2, 1-31.
- Ismail, A. r., Rani, M., Mohd Makhbul, Z., & Deros, B. (2007). *THE EFFECT OF LIGHTING ON THE WORKER PRODUCTIVITY: A STUDY AT MALAYSIA ELECTRONICS INDUSTRY*.
- Jia, C., Batterman, S., & Godwin, C. (2008). VOCs in industrial, urban and suburban neighborhoods—Part 2: Factors affecting indoor and outdoor concentrations. *Atmospheric Environment*, 42(9), 2101-2116. doi:<https://doi.org/10.1016/j.atmosenv.2007.11.047>
- Karaduman, A., Şimşek, E. H., Çetin Koçak, M., & Bilgesü, A. Y. (2002). USE OF CYCLOHEXANE AS SOLVENT IN THERMAL DEGRADATION OF LOW DENSITY POLYETHYLENE WASTES. *Polymer-Plastics Technology and Engineering*, 41(4), 767-776. doi:10.1081/PPT-120006447
- Kelly, M., Strazdins, L., Dellora, T., Khamman, S., Seubsman, S.-A., & Sleigh, A. C. (2010). Thailand's Work and Health Transition. *International labour review*, 149(3), 373-386. doi:10.1111/j.1564-913X.2010.00092.x
- Kim, Y.-M., Harrad, S., & Harrison, R. (2002). Levels and Sources of Personal Inhalation Exposure to Volatile Organic Compounds. *Environmental Science & Technology*, 36, 5405-5410. doi:10.1021/es010148y
- Kiran Ciliz, N., Ekinçi, E., & Snape, C. E. (2004). Pyrolysis of virgin and waste polypropylene and its mixtures with waste polyethylene and polystyrene. *Waste Management*, 24(2), 173-181. doi:<https://doi.org/10.1016/j.wasman.2003.06.002>
- Kjellstrom, T., Holmer, I., & Lemke, B. (2009). Workplace heat stress, health and productivity – an increasing challenge for low and middle-income countries during climate change. *Global health action*, 2(1), 2047. doi:10.3402/gha.v2i0.2047
- KRÁLIKOVÁ, R. (2015). INFLUENCE OF LIGHTING QUALITY ON PRODUCTIVITY AND HUMAN HEALTH  
*Journal of Environmental Protection, Safety, Education and Management*, 3.
- Kumar, A., & Vیدن, I. (2007). Volatile Organic Compounds: Sampling Methods and Their Worldwide Profile in Ambient Air. *Environmental Monitoring and Assessment*, 131(1), 301-321. doi:10.1007/s10661-006-9477-1

- Lebreton, L., & Andrady, A. (2019). Future scenarios of global plastic waste generation and disposal. *Palgrave Communications*, 5(1), 6. doi:10.1057/s41599-018-0212-7
- Maier, C., & Calafut, T. (2008). *Polypropylene: The Definitive User's Guide and Databook*: Elsevier Science.
- Makin, A. M., & Winder, C. (2008). A new conceptual framework to improve the application of occupational health and safety management systems. *Safety Science*, 46(6), 935-948. doi:<https://doi.org/10.1016/j.ssci.2007.11.011>
- Mečiarová, L., Vilčeková, S., Burdová, E. K., & Kiselák, J. (2017). Factors Effecting the Total Volatile Organic Compound (TVOC) Concentrations in Slovak Households. *International journal of environmental research and public health*, 14(12), 1443. doi:10.3390/ijerph14121443
- Ministerial regulation on the prescribing of standard for administration and management of occupational safety, health and environment (2006).
- Moraga, G., Huysveld, S., Mathieux, F., Blengini, G. A., Alaerts, L., Van Acker, K., . . . Dewulf, J. (2019). Circular economy indicators: What do they measure? *Resources, Conservation and Recycling*, 146, 452-461. doi:<https://doi.org/10.1016/j.resconrec.2019.03.045>
- Mutti, A., Falzoi, M., Lucertini, S., Arfini, G., Zignani, M., Lombardi, S., & Franchini, I. (1984). n-Hexane metabolism in occupationally exposed workers. *British Journal of Industrial Medicine*, 41(4), 533-538. doi:10.1136/oem.41.4.533
- Nabizadeh, R., Sorooshian, A., Delikhoon, M., Baghani, A. N., Golbaz, S., & Aghaei, M. (2020). Dataset on specifications, carcinogenic and non-carcinogenic risk of volatile organic compounds during recycling paper and cardboard. *Data in brief*, 29, 105296-105296. doi:10.1016/j.dib.2020.105296
- NIOSH Manual of Analytical Methods (NMAM)*. (2016). (5th ed.): The National Institute for Occupational Safety and Health.
- Nkwachukwu, O. I., Chima, C. H., Ikenna, A. O., & Albert, L. (2013). Focus on potential environmental issues on plastic world towards a sustainable plastic recycling in developing countries. *International Journal of Industrial Chemistry*, 4(1), 34. doi:10.1186/2228-5547-4-34
- Ohura, T., Amagai, T., Shen, X., Li, S., Zhang, P., & Zhu, L. (2009). Comparative study on indoor air quality in Japan and China: Characteristics of residential indoor and outdoor VOCs. *Atmospheric Environment*, 43(40), 6352-6359. doi:<https://doi.org/10.1016/j.atmosenv.2009.09.022>
- Organization, I. L. (2011). *OSH Management Systems: A tool for continual improvement* (ISBN 978-92-2-124740-1). Retrieved from
- Park, J., Jeong, H., Hong, S., Park, J.-T., Kim, D.-S., Kim, J., & Kim, H.-J. (2013). Effects of health and safety problem recognition on small business facility investment. *Annals of occupational and environmental medicine*, 25(1), 26-26. doi:10.1186/2052-4374-25-26
- Parthasarathy, S., Chan, W., Fisk, W., & McKone, T. (2012). Modeling indoor exposures to VOCs and SVOCs as ventilation rates vary. *10th International Conference on Healthy Buildings 2012*, 3, 2497-2502.
- Patel, S. H., & Xanthos, M. (1995). Volatile emissions during thermoplastics processing—a review. *Advances in Polymer Technology*, 14(1), 67-77. doi:10.1002/adv.1995.060140107

- Payne-Sturges, D. C., Burke, T. A., Breysse, P., Diener-West, M., & Buckley, T. J. (2004). Personal exposure meets risk assessment: a comparison of measured and modeled exposures and risks in an urban community. *Environ Health Perspect*, *112*(5), 589-598. doi:10.1289/ehp.6496
- Phan, R. W., & Santiponwut, S. (2004). *Factors influencing the manufacturers' acceptance to implement the occupational health and safety management systems*. Paper presented at the The 42<sup>th</sup> Kasetsart University Academic Conference, Bangkok.
- Pospíšil, J., Horák, Z., Pilař, J., Billingham, N. C., Zweifel, H., & Nešpůrek, S. (2003). Influence of testing conditions on the performance and durability of polymer stabilisers in thermal oxidation. *Polymer Degradation and Stability*, *82*(2), 145-162. doi:[https://doi.org/10.1016/S0141-3910\(03\)00210-6](https://doi.org/10.1016/S0141-3910(03)00210-6)
- Ragaert, K., Delva, L., & Geem, K. (2017). Mechanical and chemical recycling of solid plastic waste. *Waste Management*, *69*. doi:10.1016/j.wasman.2017.07.044
- Ramesh, R., S, M., & Senthilkumar, P. (2017). Hazard Identification and Risk Assessment in Automotive Industry. *International Journal of ChemTech Research*, *10*, 352-358.
- Ramírez, N., Cuadras, A., Rovira, E., Borrull, F., & Marcé, R. M. (2012). Chronic risk assessment of exposure to volatile organic compounds in the atmosphere near the largest Mediterranean industrial site. *Environment International*, *39*(1), 200-209. doi:<https://doi.org/10.1016/j.envint.2011.11.002>
- Regulation of Department of Industrial Works. Re: Criteria for hazard identification, risk assessment, and establishment of risk management plan B.E. 2543 (2000).
- Rhodes, J., Nirlo, E., Srebric, J., & Siegel, J. (2011). Indoor Air Quality in Retail Stores: A Review. *12th International Conference on Indoor Air Quality and Climate 2011*, *4*.
- Romagnoli, E., Barboni, T., Santoni, P. A., & Chiaramonti, N. (2014a). Quantification of volatile organic compounds in smoke from prescribed burning and comparison with occupational exposure limits. *Natural Hazards and Earth System Sciences*, *14*. doi:10.5194/nhess-14-1049-2014
- Romagnoli, E., Barboni, T., Santoni, P. A., & Chiaramonti, N. (2014b). Quantification of volatile organic compounds in smoke from prescribed burning and comparison with occupational exposure limits. *Nat. Hazards Earth Syst. Sci.*, *14*(5), 1049-1057. doi:10.5194/nhess-14-1049-2014
- Rösch, C., Kohajda, T., Röder, S., Bergen, M. v., & Schlink, U. (2014). Relationship between sources and patterns of VOCs in indoor air. *Atmospheric Pollution Research*, *5*(1), 129-137. doi:<https://doi.org/10.5094/APR.2014.016>
- Rumchev, K., Brown, H., & Spickett, J. (2007). Volatile organic compounds: Do they present a risk to our health? *Reviews on Environmental Health*, *22*(1), 39-55. doi:10.1515/REVEH.2007.22.1.39
- Safety and Health at Work Promotion Association (Thailand). Retrieved from [http://www.shawpat.or.th/index.php?option=com\\_phocadownload&view=category&id=12:ministerial-regulation&Itemid=157](http://www.shawpat.or.th/index.php?option=com_phocadownload&view=category&id=12:ministerial-regulation&Itemid=157)
- Sari, R., Syahputri, K., Rizkya, I., & Siregar, I. (2017). Identification of Potential Hazard using Hazard Identification and Risk Assessment. *IOP Conference Series: Materials Science and Engineering*, *180*, 012120. doi:10.1088/1757-899X/180/1/012120



- Sarma, S. N., Kim, Y.-J., & Ryu, J.-C. (2011). Differential gene expression profiles of human leukemia cell lines exposed to benzene and its metabolites. *Environmental Toxicology and Pharmacology*, 32(2), 285-295. doi:<https://doi.org/10.1016/j.etap.2011.06.001>
- Scheepers, P. T., Konings, J., Demirel, G., Gaga, E. O., Anzion, R., Peer, P. G., . . . van Doorn, W. (2010). Determination of exposure to benzene, toluene and xylenes in Turkish primary school children by analysis of breath and by environmental passive sampling. *Sci Total Environ*, 408(20), 4863-4870. doi:10.1016/j.scitotenv.2010.06.037
- Shanh, F. G., Rahimnejad, S., Bahrami, A., & Farhadian, M. (2017). Risk Assessment of Workers' Exposure to Volatile Organic Compounds in the Air of a Petrochemical Complex in Iran. *Indian journal of occupational and environmental medicine*, 21(3), 121-127. doi:10.4103/ijoem.IJOEM\_86\_17
- Soni V., S. P., Shree V., Goel V (2018). Effects of VOCs on Human Health. In *Air Pollution and Control. Energy, Environment, and Sustainability*: Springer, Singapore.
- Suhardi, B., Laksono, P., Ayu, V. E. A., Mohd.Rohani, J., & Ching, T. S. (2018). Analysis of the potential Hazard Identification and Risk Assessment (HIRA) and Hazard Operability Study (HAZOP): Case study. *International Journal of Engineering and Technology(UAE)*, 7, 1-7. doi:10.14419/ijet.v7i3.24.17290
- Summary Ministerial Regulation on the Prescribing of Standard for Administration and Management of Occupational Safety, Health and Work Environment in Relation to Heat Light and Noise, (B.E. 2549 (2006)).
- Tawatsupa, B., Lim, L.-Y., Kjellstrom, T., Seubsman, S.-a., & Sleigh, A. (2010). The association between overall health, psychological distress, and occupational heat stress among a large national cohort of 40,913 Thai workers. *Global health action*, 3(1), 5034. doi:10.3402/gha.v3i0.5034
- Tawatsupa, B., Lim, L. L. Y., Kjellstrom, T., Seubsman, S.-a., Sleigh, A., & Study Team, t. T. C. (2012). Association Between Occupational Heat Stress and Kidney Disease Among 37 816 Workers in the Thai Cohort Study (TCS). *Journal of Epidemiology*, 22(3), 251-260. doi:10.2188/jea.JE20110082
- Tsai, C.-J., Chen, M.-L., Chang, K.-F., Chang, F.-K., & Mao, I. F. (2009). The pollution characteristics of odor, volatile organochlorinated compounds and polycyclic aromatic hydrocarbons emitted from plastic waste recycling plants. *Chemosphere*, 74(8), 1104-1110. doi:<https://doi.org/10.1016/j.chemosphere.2008.10.041>
- U.S. EPA. *Exposure Factors Handbook (Final Report)* (2011). Retrieved from USEPA. Integrated Risk Information System (IRIS) Retrieved from <https://www.epa.gov/iris>. <https://www.epa.gov/iris>
- Utembe, W., Faustman, E. M., Matatiele, P., & Gulumian, M. (2015). Hazards identified and the need for health risk assessment in the South African mining industry. *Hum Exp Toxicol*, 34(12), 1212-1221. doi:10.1177/0960327115600370
- Vejerano, E. P., Holder, A. L., & Marr, L. C. (2013). Emissions of Polycyclic Aromatic Hydrocarbons, Polychlorinated Dibenzo-p-Dioxins, and Dibenzofurans from Incineration of Nanomaterials. *Environmental Science & Technology*, 47(9), 4866-4874. doi:10.1021/es304895z

- Venugopal, V., Chinnadurai, J., Lucas, R., & Kjellstrom, T. (2015). Occupational Heat Stress Profiles in Selected Workplaces in India. *International journal of environmental research and public health*, 13, 89. doi:10.3390/ijerph13010089
- Vinothkumar, S. (2018). *Utilization of Upgraded Shredder Blade and Recycling the Waste Plastic and Rubber Tyre*.
- Whiteley, K. S., Heggs, T. G., Koch, H., Mawer, R. L., & Immel, W. (2000). *Polyolefins*.
- Wichai-utcha, N., & Chavalparit, O. (2019). 3Rs Policy and plastic waste management in Thailand. *Journal of Material Cycles and Waste Management*, 21(1), 10-22. doi:10.1007/s10163-018-0781-y
- Xiang, Q., Mitra, S., Xanthos, M., & Dey, S. K. (2002). Evolution and Kinetics of Volatile Organic Compounds Generated during Low-Temperature Polymer Degradation. *Journal of the Air & Waste Management Association*, 52(1), 95-103. doi:10.1080/10473289.2002.10470757
- Yamashita, K., Yamamoto, N., Mizukoshi, A., Noguchi, M., Ni, Y., & Yanagisawa, Y. (2009). Compositions of Volatile Organic Compounds Emitted from Melted Virgin and Waste Plastic Pellets. *Journal of the Air & Waste Management Association*, 59(3), 273-278. doi:10.3155/1047-3289.59.3.273
- Yamashita, K., Yamamoto, N., Mizukoshi, A., Noguchi, M., Ni, Y., & Yanagisawa, Y. (2009). Compositions of volatile organic compounds emitted from melted virgin and waste plastic pellets. *J Air Waste Manag Assoc*, 59(3), 273-278. doi:10.3155/1047-3289.59.3.273
- Ye, D., Klein, M., Chang, H. H., Sarnat, J. A., Mulholland, J. A., Edgerton, E. S., . . . Sarnat, S. E. (2017). Estimating Acute Cardiorespiratory Effects of Ambient Volatile Organic Compounds. *Epidemiology (Cambridge, Mass.)*, 28(2), 197-206. doi:10.1097/EDE.0000000000000607
- Yoshida, T. (2009). Simultaneous determination of 18 pyrethroids in indoor air by gas chromatography/mass spectrometry. *J Chromatogr A*, 1216(26), 5069-5076. doi:10.1016/j.chroma.2009.04.087
- Zhou, C., Zhan, Y., Chen, S., Xia, M., Ronda, C., Sun, M., . . . Shen, X. (2017). Combined effects of temperature and humidity on indoor VOCs pollution: Intercity comparison. *Building and Environment*, 121, 26-34. doi:<https://doi.org/10.1016/j.buildenv.2017.04.013>
- Zhou, L.-J., Cao, Q.-G., Yu, K., Wang, L.-L., & Wang, H.-B. (2018). Research on Occupational Safety, Health Management and Risk Control Technology in Coal Mines. *International journal of environmental research and public health*, 15(5), 868. doi:10.3390/ijerph15050868
- Zia, K. M., Bhatti, H. N., & Ahmad Bhatti, I. (2007). Methods for polyurethane and polyurethane composites, recycling and recovery: A review. *Reactive and Functional Polymers*, 67(8), 675-692. doi:<https://doi.org/10.1016/j.reactfunctpolym.2007.05.004>
- Zuraimi, M. S., Roulet, C. A., Tham, K. W., Sekhar, S. C., David Cheong, K. W., Wong, N. H., & Lee, K. H. (2006). A comparative study of VOCs in Singapore and European office buildings. *Building and Environment*, 41(3), 316-329. doi:<https://doi.org/10.1016/j.buildenv.2005.01.028>

## Appendix A



*Fume extraction system of Plant A*



*Fume extraction system of Plant B*

## Appendix B

*Table S1 Indoor VOC concentrations of the different period of the day*

	Recycling practice	VOCs	Indoor VOC concentration (mg/m <sup>3</sup> )				Mean exposure concentration
			8.00-10.00	10.00-12.00	12.00-14.00	14.00-16.00	
Plant A	PP	Hexane	2.122	ND	1.129	0.274	1.175
		Toluene	NA	0.731	0.402	0.219	0.451
		TVOC					1.626
	PE	Hexane	1.198	ND	0.992	0.137	0.776
		Toluene	0.731	0.256	0.256	NA	0.414
		TVOC					1.190
Plant B	PP	Hexane	0.992	0.342	0.548	NA	0.627
		Toluene	0.364	0.329	0.183	NA	0.292
		TVOC					0.919

ND-Not detected

NA-Not applicable

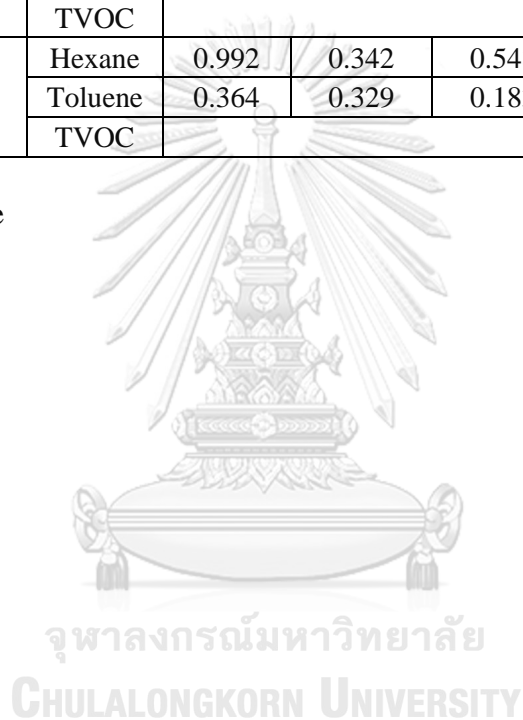



## Appendix C

*Table S2 Individual exposure data of workers in plastic recycling plants*

Recycling Plant	Worker's number	Body weight(kg)	Sex
Plant A	W1	48	Male
	W2	55	Male
	W3	42	Female
	W4	62	Male
	W5	58	Male
	W6	56	Male
Plant B	W1	65	Male
	W2	73	Male
	W3	54	Male
	W4	51	Male
	W5	61	Male

*Table S3 Dose-response data used for the risk characterization*

VOC	TLA-TWA <sup>a</sup>	RfC (mg/m <sup>3</sup> ) <sup>b</sup>	RfD (mg/kg.day) <sup>b</sup>
Toluene	190	5	1.431
Hexane	210	0.7	0.2

Data provided by ACGIH

Integrated Risk Information System (IRIS) of USEPA

## VITA

**NAME** Muhammed Ayaj Ansar

**DATE OF BIRTH** 21 October 1993

**PLACE OF BIRTH** Kurunegala, Srilanka

**INSTITUTIONS ATTENDED** School of Environmental, Resources and Development,  
Asian Institute of Technology, Thailand

**HOME ADDRESS** No 174/B, Melwattha, Ilukewela, Weuda, Srilanka

**AWARD RECEIVED** -Fellowship for bachelor's degree in AIT 2016  
-2018:H.M. the King Bhumibhol Adulyadej's 72nd  
Birthday Anniversary Scholarship and Top up scholarship



จุฬาลงกรณ์มหาวิทยาลัย  
CHULALONGKORN UNIVERSITY